



DEDON

COLLECTIONS 2020



DEDON

COLLECTIONS 2020



CELEBRATING THE JOURNEY

It began 30 years ago with the creation of a revolutionary fiber. Explorers by nature, DEDON went searching for artisans skillful enough to weave this fiber into the world's most luxurious outdoor designs. The journey led to Cebu, the Philippine island that would become the company's second home. Twenty years ago, DEDON launched its first manufacturing facility there. A new era of exploration had begun.

Taking quality and sustainability into its own hands, DEDON discovered new materials, technologies and ways to collaborate with leading designers and artisans around the world. The new collections for 2020 are the latest expressions of the company's relentless drive to innovate and explore.

RILLY by GamFratesi takes a fresh approach to DEDON's outdoor heritage. With its friendly forms, flowing lines, faceted canopies and semi-transparent vertical weave, the collection lets users create unique landscapes in any setting.

SEALINE by Jean-Marie Massaud, a luxurious lounge collection with an easy-chic feeling, is suitable to any season or latitude. It features a handcrafted teak structure and a weave of maritime rope or extra-wide DEDON Fiber.

MBARQ by Sebastian Herkner envelops users in privacy and protective comfort. Inspired by the traditional indoor alcove, this versatile outdoor system gives structure to open spaces, defining areas in which to work, rest or chat.

CONTENTS

LOUNGING

AHNDA 10 – 13	MBARQ 74 – 79
BARCELONA 22 – 25	MBRACE 80 – 87
BREA 28 – 35	MU 88 – 95
BRIXX 36 – 41	NESTREST 96 / 97
DALA 46 – 49	ORBIT & ORBIT XXL 98 / 99
LOU 60 – 65	RAYN 110 – 117
LOUNGE 66 – 73	RILLY 118 – 123

SEALINE 126 – 131	TANGO 150 – 153
SEASHELL 132 – 135	TIBBO 154 – 159
SWINGREST 146 – 149	TIGMI 160 / 161



DINING CHAIRS

AIIR 14 – 19	PLAY WITH DEDON 104 – 107
BARCELONA 22 – 25	RILLY 118 – 123
CIRQL 42 – 45	SEASHELL 132 – 135
DEAN 50 – 51	SEAX 136 – 143
MBRACE 80 – 87	TANGO 150 – 153
PANAMA 100 – 103	TIBBO 154 – 159



TABLES

AIIR 14 – 19	MBRACE 80 – 87
BARCELONA 22 – 25	PANAMA 100 – 103

SIDE TABLES

AHNDA 10 – 13	MBRACE 82 – 87
BABYLON 20 / 21	MU 88 – 95
BARCELONA 22 – 25	PANAMA 100 – 103
BREA 28 – 35	PORCINI 108 / 109
BRIXX 36 – 41	RAYN 110 – 117
CIRQL 42 – 45	SATELLITE 124 – 125
DALA 46 – 49	SEALINE 126 – 131
IZON 52 – 57	SEASHELL 132 – 135
LOU 60 – 65	TANGO 150 – 153
LOUNGE 66 – 73	TIBBO 154 – 159

SATELLITE 124 / 125	TANGO 150 – 153
SEAX 136 – 143	TIBBO 154 – 159
	WA 162 – 165



LOUNGE CHAIRS

AHNDA
10 – 13

BARCELONA
22 – 25

BELLMONDE
26 / 27

BREA
28 – 35

BRIXX
36 – 41

CIRQL
42 – 45

DALA
46 – 49

DEAN
50 – 51

LOU
60 – 65

LOUNGE
66 – 73

MBRACE
80 – 87

MU
88 – 95

PANAMA
100 – 103

RILLY
118 – 123

SEASHELL
132 – 135

SEAX
136 – 143

SWINGREST
146 – 149

TANGO
150 – 153

TIBBO
154 – 159

ICONICS

LEAF
58 – 59

NESTREST
96 / 97

ORBIT & ORBIT XXL
98 / 99

SWINGREST
146 – 149

TIGMI
160 – 161

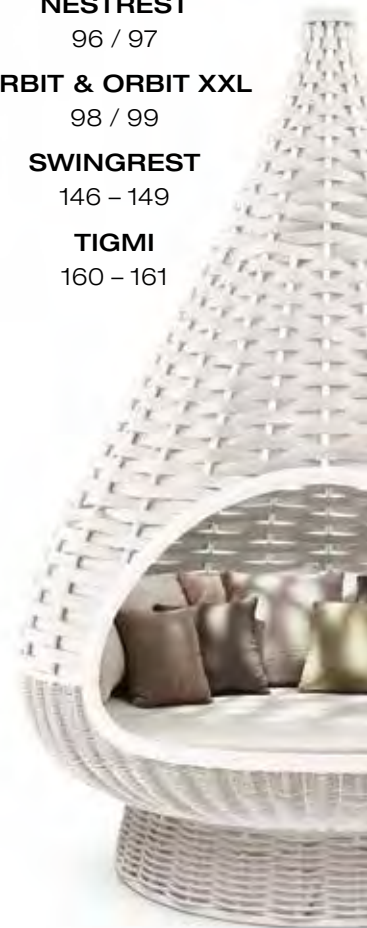

BEACH CHAIRS

BARCELONA
22 – 25

LEAF
58 – 59

LOU
60 – 65

LOUNGE
66 – 73

MBARQ
74 – 79

MBRACE
80 – 87

MU
88 – 95

PANAMA
100 – 103

RAYN
110 – 117

RILLY
118 – 123

SEASHELL
132 – 135

SEAYOU
144 / 145

TANGO
150 – 153

TIBBO
154 – 159



ACCESSORIES

BABYLON
174 – 176

DALA
178 – 179

DECO CUSHIONS
199

LA MALLE
199

LOON
172 – 173

REAV
180 – 183

THE OTHERS
168 – 171

VID
177

INFORMATION

COPYRIGHT | 186

CAPTION | 188 / 189

ROPE/FIBER | 190 / 191

TABLETOPS | 192 / 193

TEAK | 194

COVER | 196

CUSHIONS & FABRICS
198

PRODUCTS BY COLLECTION











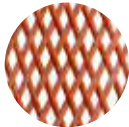

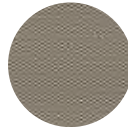



Lounge chair
2-seater
Recommended fabric: COOL dark gray
Coffee table ø 82 cm

Recommended combinations

Fiber	Powder coating	Recommended fabrics	
			
105 elemental	099 vulcano	452 COOL taupe Cat. A	661 TWIST sand Cat. B

Fiber	Powder coating	Recommended fabrics	
			
106 white quartz	304 lipari	452 COOL taupe Cat. A	660 TWIST beige Cat. B

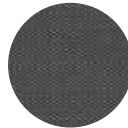
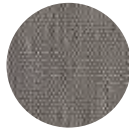
Fiber	Powder coating	Recommended fabrics	
			
108 graphite	099 vulcano	454 COOL dark gray Cat. A	662 TWIST gray Cat. B

WING CHAIR
Hochlehner
Sillón orejero
Poltrona con schienale alto
Fauteuil bergère
18 kg 1 m³



SEAT CUSHION
Sitzkissen
Cojín de asiento
Cuscino seduta
Coussin d'assise
81 x 77 cm

HEADREST CUSHION
Nackenkissen
Cojín reposacabezas
Cuscino poggiatesta
Coussin repose-tête
32 x 30 cm

DECO CUSHION
Dekokissen
Cojín de decoración
Cuscino decorativo
Coussin déco
50 x 50 cm

DECO CUSHION
Dekokissen
Cojín de decoración
Cuscino decorativo
Coussin déco
40 x 40 cm



070006

070006105

95070007

95070006

2x 95050082

1x 95050081

56070006000



070006105

SEAT CUSHION
Sitzkissen
Cojín de asiento
Cuscino seduta
Coussin d'assise
81 x 77 cm

HEADREST CUSHION
Nackenkissen
Cojín reposacabezas
Cuscino poggiatesta
Coussin repose-tête
32 x 30 cm

BACK CUSHION
Rückenkissen
Cojín de respaldo
Cuscino schienale
Coussin de dossier
76 x 38 cm

DECO CUSHION
Dekokissen
Cojín de decoración
Cuscino decorativo
Coussin déco
40 x 40 cm



070006106

95070007

95070006

95070008

1x 95050081

HEADREST CUSHION
Nackenkissen
Cojín reposacabezas
Cuscino poggiatesta
Coussin repose-tête
32 x 30 cm



070006108

95070009

HEADREST CUSHION
Nackenkissen
Cojín reposacabezas
Cuscino poggiatesta
Coussin repose-tête
32 x 30 cm

95070009

EN Regardless of the choice of fabric color, the headrest cushion of the AHNDA Wingchair is always sewn with a special thread that picks up the essential color of the furniture.

DE Unabhängig von der Wahl der Stofffarbe wird das Nackenkissen des AHNDA Hochlehners immer mit einem besonderen Faden genäht, welcher die Grundfarbe des Möbelstücks aufgreift.

ES Independientemente de la tela que se elija, el cojín reposacabezas del sillón orejero AHNDA viene con una costura acorde con el color principal del mueble.

IT Indipendentemente dal colore del rivestimento scelto, le cuciture del cuscino poggiatesta della poltrona con schienale alto AHNDA sono effettuate con filo speciale, che riprende il colore base del mobile.

FR Quelle soit la couleur choisie, le coussin repose-tête du fauteuil bergère AHNDA est toujours cousu avec un fil spécial qui reprend la couleur principale du meuble.



95070006



95070009



95070009

LOUNGE CHAIR

Sessel
Sillón bajo
Poltrona club
Fauteuil club
12 kg 0,6 m³



070005

070005105



070005105



070005106



070005108

SEAT CUSHION
Sitzkissen
Cojín de asiento
Cuscino seduta
Coussin d'assise
81 x 77 cm

95070007

SEAT CUSHION
Sitzkissen
Cojín de asiento
Cuscino seduta
Coussin d'assise
81 x 77 cm

95070007

DECO CUSHION
Dekokissen
Cojín de decoración
Cuscino decorativo
Coussin déco
50 x 50 cm

2x 95050082

BACK CUSHION
Rückenkissen
Cojín de respaldo
Cuscino schienale
Coussin de dossier
76 x 38 cm

95070008

DECO CUSHION
Dekokissen
Cojín de decoración
Cuscino decorativo
Coussin déco
40 x 40 cm

1x 95050081

DECO CUSHION
Dekokissen
Cojín de decoración
Cuscino decorativo
Coussin déco
40 x 40 cm

1x 95050081



56070005000

COFFEE TABLE / FOOTSTOOL

Kaffeetisch / Hocker
Mesa de centro / Reposapiés
Tavolino da salotto / Pouf
Table de salon / Repose-pieds
ø 82 cm
6 kg 0,2 m³



Set: 070032105

GLASS ELEMENTAL
Glas elemental
Sobre de cristal elemental
Piano in vetro elemental
Plaque en verre elemental
9,5 kg

22270031105



Set: 070032106

GLASS LIPARI
Glas lipari
Sobre de cristal lipari
Piano in vetro lipari
Plaque en verre lipari
9,5 kg

22270031304



Set: 070032108

GLASS VULCANO
Glas vulcano
Sobre de cristal vulcano
Piano in vetro vulcano
Plaque en verre vulcano
9,5 kg

22270031305



070031105

SEAT CUSHION
Sitzkissen
Cojín de asiento
Cuscino seduta
Coussin d'assise
ø 80 cm

95070031



070031106



070031108



56070031000

2-SEATER
 2er-Sofa
 Sofá 2 plazas
 Divano 2 posti
 Canapé 2 places
 15 kg 1,1 m³



070012

070012105

SEAT CUSHION
 Sitzkissen
 Cojín de asiento
 Cuscino seduta
 Coussin d'assise
 154 x 81,5 cm

BACK CUSHION
 Rückenkissen
 Cojín de respaldo
 Cuscino schienale
 Coussin de dossier
 152 x 38 cm



95070012

95070013

56070012000



070012105

SEAT CUSHION
 Sitzkissen
 Cojín de asiento
 Cuscino seduta
 Coussin d'assise
 154 x 81,5 cm

DECO CUSHION
 Dekokissen
 Cojín de decoración
 Cuscino decorativo
 Coussin déco
 50 x 50 cm

95070012

5x 95050082



070012106



070012108

Tabletop glass



105 elemental

304 lipari

305 vulcano



Armchair, salt
 Side chair, salt
 Seat cushion: Kvadrat patio110
 Dining table 4+2, 100x200 cm

Recommended combinations

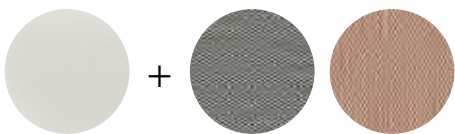

135
salt

+

458
COOL ash
Cat. A

663
TWIST terracotta
Cat. B

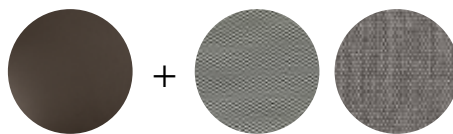

132
pepper

+

458
COOL ash
Cat. A

662
TWIST gray
Cat. B

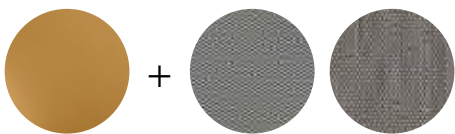

131
saffron

+

458
COOL ash
Cat. A

662
TWIST gray
Cat. B

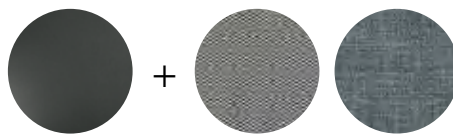

133
nori

+

458
COOL ash
Cat. A

664
TWIST dark turquoise
Cat. B

ARMCHAIR
 Armlehnstuhl
 Silla con brazos
 Poltrona pranzo
 Fauteuil repas
 6 kg 0,25 m³



301001135

SEAT CUSHION
 Sitzkissen
 Cojín de asiento
 Cuscino seduta
 Coussin d'assise
 43 x 44,5 cm

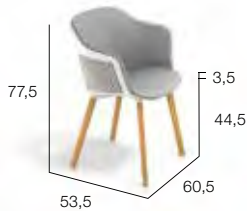

95300001

CUSHION
 Polsterauflage
 Cojín
 Cuscino
 Coussin matelassé
 43 x 44,5 cm + 59 x 35,5 cm



95300002

56300001000



307001132



308001131



309001133

ARMCHAIR
 Armlehnstuhl
 Silla con brazos
 Poltrona pranzo
 Fauteuil repas
 6,4 kg 0,25 m³



301002135

SEAT CUSHION
 Sitzkissen
 Cojín de asiento
 Cuscino seduta
 Coussin d'assise
 43 x 44,5 cm

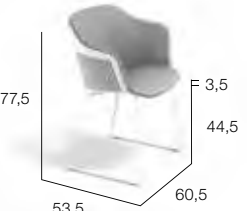

95300001

CUSHION
 Polsterauflage
 Cojín
 Cuscino
 Coussin matelassé
 43 x 44,5 cm + 59 x 35,5 cm



95300002

56300001000



307002132



ARMCHAIR
 Armlehnstuhl
 Silla con brazos
 Poltrona pranzo
 Fauteuil repas
 6,4 kg 0,25 m³



308002**131**



SEAT CUSHION
 Sitzkissen
 Cojín de asiento
 Cuscino seduta
 Coussin d'assise
 43 x 44,5 cm

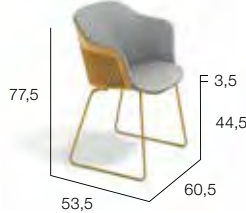

95300001

CUSHION
 Polsterauflage
 Cojín
 Cuscino
 Coussin matelassé
 43 x 44,5 cm + 59 x 35,5 cm



95300002

56300001000



309002**133**



SIDE CHAIR
 Essstuhl
 Silla de comedor
 Sedia pranzo
 Chaise repas
 5,4 kg 0,22 m³



301003**135**



SEAT CUSHION
 Sitzkissen
 Cojín de asiento
 Cuscino seduta
 Coussin d'assise
 43 x 44,5 cm

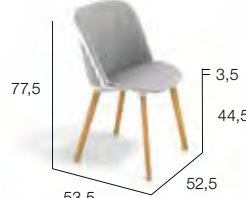

95300001

CUSHION
 Polsterauflage
 Cojín
 Cuscino
 Coussin matelassé
 43 x 44,5 cm + 54,5 x 35,5 cm



95300003

56300003000



307003**132**



308003**131**



309003**133**



Chair base options

Teak legs



205
teak

Powder coating sled base

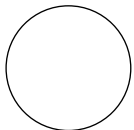

000
white



317
black pepper



131
saffon



133
nori

SIDE CHAIR
 Essstuhl
 Silla de comedor
 Sedia pranzo
 Chaise repas
 5,8 kg 0,22 m³



301004135

SEAT CUSHION
 Sitzkissen
 Cojín de asiento
 Cuscino seduta
 Coussin d'assise
 43 x 44,5 cm



95300001

CUSHION
 Polsterauflage
 Cojín
 Cuscino
 Coussin matelassé
 43 x 44,5 cm + 54,5 x 35,5 cm



95300003 56300003000



307004132



308004131



309004133



EN The seats of the AIIR armchairs and side chairs consist of injection molded polypropylene, while the bases are made of premium teak or powder coated stainless steel, which we recommend cleaning periodically to prevent stains. AIIR dining tables come with teak legs and HPL tabletops. Clean teak legs with warm water in which natural soap flakes have been dissolved.

DE Die Sitzschalen der Sessel und Stühle der AIIR-Reihe werden im Spritzgussverfahren aus Polypropylen hergestellt. Die Untergestelle bestehen aus Premium-Teak oder pulverbeschichtetem Edelstahl. Wir empfehlen eine regelmäßige Reinigung des Untergestells, um Fleckenbildung zu vermeiden. Die Beine der AIIR-Esstische sind aus Premium-Teak gefertigt, die Tischplatten bestehen aus HPL. Das Teak-Gestell mit warmem Wasser reinigen, in dem natürliche Seifenflocken vollständig aufgelöst wurden.

ES Los asientos de los sillones y de las sillas AIIR están hechos de polipropileno moldeado por inyección mientras que las bases están elaboradas con teca de primera calidad o acero inoxidable revestido de pintura en polvo, el cual recomendamos limpiar periódicamente para prevenir manchas. Las mesas comedor de AIIR cuentan con patas de teca y tableros HPL. Lavar las patas de teca con agua templada y jabón natural en copos bien disueltos.

IT Le sedute delle sedie AIIR sono realizzate in polipropilene con il metodo di stampaggio a iniezione. I telai sono in pregiato teak o in acciaio inox verniciato a polvere. Consigliamo di pulire con egolarità il telaio metallico per prevenire la presenza di macchie. I tavoli da pranzo AIIR hanno gambe in teak e piani in HPL. È consigliato pulire il teak con acqua calda in cui sono state dissolte scaglie di sapone naturale.

FR Les sièges des fauteuils et des chaises AIIR sont composés de polypropylène moulé par injection, tandis que les bases sont en teck de qualité supérieure ou en acier inoxydable avec revêtement poudre, que nous recommandons de nettoyer régulièrement pour éviter l'apparition de taches. Les tables AIIR sont fournies avec des pieds en teck et des plateaux à revêtement stratifié. Nettoyez la base en teck avec de l'eau chaude dans laquelle ont été dissous des copeaux de savon naturel.

DINING TABLE

Esstisch
Mesa Comedor
Tavolo pranzo
Table repas
100 x 100 cm
26,8 kg 0,75 m³



00303079**099**



00303079**306**

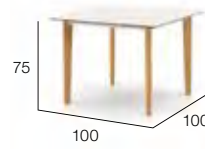

00303079**001**



2+2



56300079000

DINING TABLE

Esstisch
Mesa Comedor
Tavolo pranzo
Table repas
100 x 160 cm
36,5 kg 1,2 m³



00303071**099**



00303071**306**

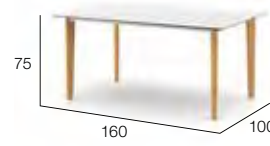

00303071**001**



4+2



56300071000

DINING TABLE

Esstisch
Mesa Comedor
Tavolo pranzo
Table repas
100 x 200 cm
45,8 kg 1,5 m³



00303072**099**



00303072**306**

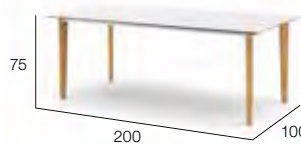

00303072**001**



4+2



56300072000

DINING TABLE

Esstisch
Mesa Comedor
Tavolo pranzo
Table repas
100 x 250 cm
58,2 kg 1,88 m³



00303064**099**



00303064**306**

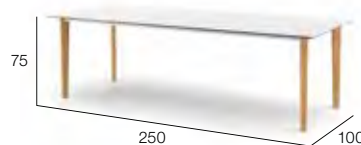

00303064**001**



6+2



56300064000

Tabletop HPL



099
vulcano



NEW

306
lipari 2.0



000
white



Armchair, nori

BABYLON SIDE TABLE

Design by HARRY-PAUL



Side table ceramic

Material

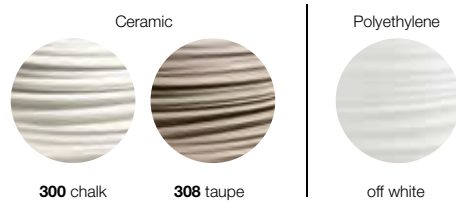

STOOL / SIDE TABLE CERAMIC
Hocker / Beistelltisch Keramik
Asiento / Mesa auxiliar de cerámica
Pouf / Tavolino ceramica
Tabouret / Table d'appoint en céramique
ø 52,5 cm
17 kg 0,12 m³



053089300



053089308

STOOL / SIDE TABLE PE
Hocker / Beistelltisch PE
Asiento / Mesa auxiliar de PE
Pouf / Tavolino PE
Tabouret / Table d'appoint PE
ø 52,5 cm
5 kg 0,12 m³

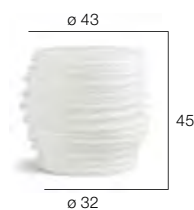

053111000

EN Made of Monolite Ipergres®: Frost proof, non-absorbing ceramic material with excellent resistance to scratches, abrasion and indirect tensile stress. Due to method of production, the side table does not have an entirely flat surface. BABYLON PE consists of rotomolded polyethylene: easy to maintain, 100% recyclable, light yet robust at the same time.

DE Aus Monolite Ipergres®: ein frostsicheres, wasserabweisendes Keramikmaterial mit ausgezeichneter Kratz- und Abriebfestigkeit. Aus produktionstechnischen Gründen hat der Beistelltisch keine vollständig glatte Oberfläche. BABYLON PE ist aus Rotationsguss-geschertem Polyethylen hergestellt: einfach zu pflegen, gleichzeitig leicht und widerstandsfähig, 100% recyclingfähig.

ES Fabricado en Monolite Ipergres® es un material cerámico resistente a las heladas y hermético al agua, con una resistencia excelente contra los arañazos, la abrasión así como a la presión indirecta. Debido a su método de producción, las mesas auxiliares no tienen una superficie completamente regular. BABYLON PE: Fabricado en polietileno rotomol-deado (PE). De fácil mantenimiento, ligero y al mismo tiempo resistente, 100% reciclable.

IT Fabricato in Monolite Ipergres®: un materiale ceramico resistente al gelo, non assorbente con una resistenza eccellente ai graffi e alle abrasioni. A causa del metodo di produzione, il tavolino non presenta una superficie completamente liscia. BABYLON PE: Fabricato in polietilene rotostampato. Di facile manutenzione, leggero e allo stesso tempo resistente, 100% riciclabile.

FR En Monolite Ipergres® : matériau céramique résistant au gel, imperméable et hautement résistant aux contraintes de traction indirectes, aux rayures et à l'abrasion. En raison des méthodes de production, la surface de la table d'appoint n'est pas complètement plane. BABYLON PE: En Polyéthylène (PE) rotomoulé. Facile d'entretien, à la fois léger et résistant. 100% recyclable.





Armchair
Cushion: COOL white

Recommended combinations



+



450
COOL white
Cat. A



661
TWIST sand
Cat. B



083
chalk

+

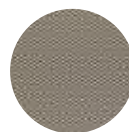

452
COOL taupe
Cat. A

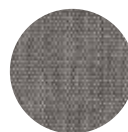

662
TWIST gray
Cat. B

ARMCHAIR
Armlehnstuhl
Silla con brazos
Poltrona pranzo
Fauteuil repas
7 kg 0,34 m³



027001040

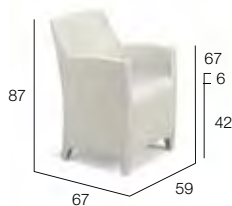

027001083

SEAT CUSHION
Sitzkissen
Cojín de asiento
Cuscino seduta
Coussin d'assise
45 x 46 cm



027001

95027001

56027001000

DINING TABLE
Esstisch
Mesa comedor
Tavolo pranzo
Table repas
100 x 100 cm
9,5 kg 0,75 m³



Set: 227270040



Set: 227270083

SATINATED GLASS TOP
Satinierter Glasplatte
Sobre de cristal satinado
Piano in vetro satinato
Plaque en verre satinée
15,5 kg



2+2



127270

22227075000

56027076000

DINING TABLE
Esstisch
Mesa comedor
Tavolo pranzo
Table repas
100 x 200 cm
11 kg 1,5 m³



Set: 227120040



Set: 227120083

SATINATED GLASS TOP
Satinierter Glasplatte
Sobre de cristal satinado
Piano in vetro satinato
Plaque en verre satinée
33 kg



4+2



127120

22227065000

56027066000

LOUNGE CHAIR
Sessel
Sillón bajo
Poltrona club
Fauteuil club
10 kg 0,54 m³



027005040



027005083

SEAT CUSHION + BACK CUSHION
Sitzkissen + Rückenkissen
Cojín de asiento + Cojín de respaldo
Cuscino seduta + Cuscino schienale
Coussin d'assise + Coussin de dossier
56 x 61 cm + 50 x 60 cm



027005

95027005

56027005000

2-SEATER
2er-Sofa
Sofá 2 plazas
Divano 2 posti
Canapé 2 places
15 kg 1,1 m³



027012040



027012083

2x SEAT CUSHIONS + 2x BACK CUSHIONS
2x Sitzkissen + 2x Rückenkissen
2x Cojines de asiento + 2x Cojines de respaldo
2x Cuscini seduta + 2x Cuscini schienale
2x Coussins d'assise + 2x Coussins de dossier
2x 67 x 61 cm + 2x 50 x 60 cm



027012

95027012

56027012000

CORNER MODULE
Eckmodul
Módulo esquina
Modulo d'angolo
Module d'angle
11 kg 0,58 m³



027003040



027003083

SEAT CUSHION + 3x DECO CUSHIONS
Sitzkissen + 3x Dekokissen
Cojín asiento + 3x Cojines decoración
Cuscino seduta + 3x Cuscini decorativo
Coussin d'assise + 3x Coussins déco
71 x 71 cm + 1x 40 x 60 cm + 2x 50 x 60 cm



027003

95027003

56027003000

RECOMMENDED DECO CUSHIONS
Empfohlene Dekokissen
Cojines decoración recomendados
Cuscini decorativi consigliati
Coussins déco recommandés

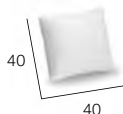

95050081

CENTER MODULE

Modul mitte
Módulo centro
Modulo centrale
Module central
9 kg 0,51 m³



027007040



027007083

SEAT CUSHION + 2x DECO CUSHIONS
Sitzkissen + 2x Dekokissen
Cojín de asiento + 2x Cojines de decoración
Cuscino seduta + 2x Cuscini decorativo
Coussin d'assise + 2x Coussins déco
80 x 71 cm + 1x 40 x 60 cm + 1x 50 x 60 cm



027007

95027007

56027007000

DAYBED LEFT

Daybed links
Daybed izquierdo
Daybed sinistro
Daybed gauche
18,5 kg 1,09 m³



027003040 + 027037040



027003083 + 027037083

SEAT CUSHION + 3x DECO CUSHIONS
Sitzkissen + 3x Dekokissen
Cojín de asiento + 3x Cojines decoración
Cuscino seduta + 3x Cuscini decorativo
Coussin d'assise + 3x Coussins déco
151 x 80 cm + 1x 60 x 40 cm + 2x 60 x 50 cm



027003 + 027037

95027018

56027018000

DAYBED RIGHT

Daybed rechts
Daybed derecho
Daybed destro
Daybed droit
18,5 kg 1,09 m³



027003040 + 027037040



027003083 + 027037083

SEAT CUSHION + 3x DECO CUSHIONS
Sitzkissen + 3x Dekokissen
Cojín de asiento + 3x Cojines decoración
Cuscino seduta + 3x Cuscini decorativo
Coussin d'assise + 3x Coussins déco
151 x 80 cm + 1x 60 x 40 cm + 2x 60 x 50 cm



027003 + 027037

95027017

56027017000

BEACH CHAIR

Sonnenliege
Tumbona
Lettino
Chaise longue
19 kg 0,6 m³



027020040



027020083

CUSHION
Kissen
Cojín
Cuscino
Coussin
78 x 187 cm



027020

95027020

56027020000

FOOTSTOOL / COFFEE TABLE

Hocker / Kaffeetisch
Reposapiés / Mesa de centro
Pouf / Tavolino da salotto
Repose-pieds / Table de salon
80 x 80 cm
7,5 kg 0,2 m³



027037040



027037083

SEAT CUSHION
Sitzkissen
Cojín de asiento
Cuscino seduta
Coussin d'assise
80 x 80 cm



027037

95027037

56027037000



Set: 027038040



Set: 027038083

CLEAR GLASS TOP
Klarglasplatte
Sobre de cristal transparente
Piano in vetro trasparente
Plaque en verre clair
8,7 kg



22226082000

56027038000

Tabletops glass



000 satinated glass
Bottom: satinated
BARCELONA dining table



000 clear glass
BARCELONA coffee table

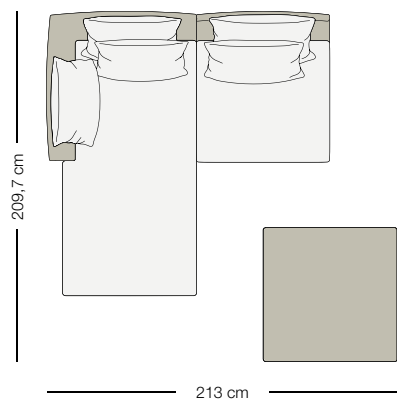

BARCELONA Setting 01

- 1x **027003 + 027037** – Daybed right, seat cushion + 3x Deco cushion
- 1x **027007** – Center module, seat cushion + 2x deco cushion
- 1x **027038** – Coffee table incl. glass tabletop

Recommended deco cushions:

- 2x **95050081** – 40 x 40 cm

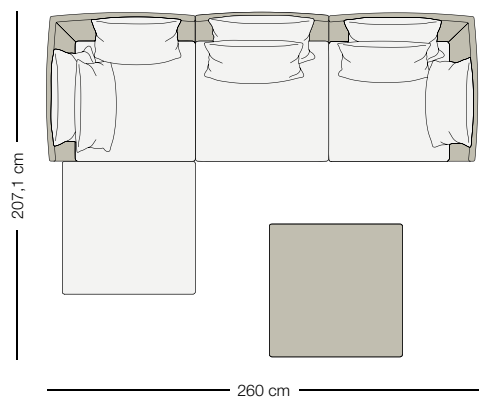

BARCELONA Setting 02

- 2x **027003** – Corner module, seat cushion + 3x deco cushion
- 1x **027007** – Center module, seat cushion + 2x deco cushion
- 1x **027037** – Footstool 80 x 80 cm, seat cushion
- 1x **027038** – Coffee table incl. glass tabletop

Recommended deco cushions:

- 3x **95050081** – 40 x 40 cm

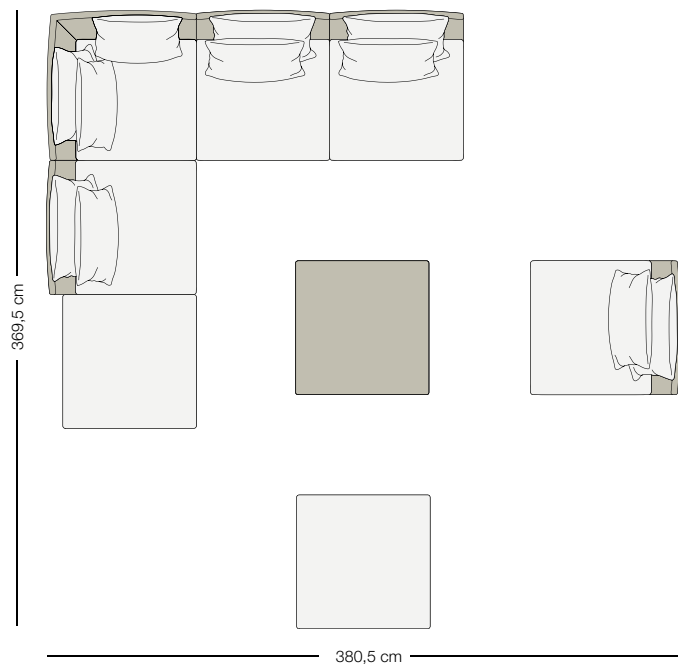

BARCELONA Setting 03





- 1x **027003** – Corner module, seat cushion + 3x deco cushion
- 4x **027007** – Center module, seat cushion + 2x deco cushion
- 2x **027037** – Footstool 80 x 80 cm, seat cushion
- 1x **027038** – Coffee table incl. glass tabletop





Recommended deco cushions:

- 5x **95050081** – 40 x 40 cm

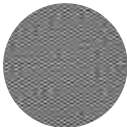

Recommended combinations

Fiber	Powder coating	Recommended fabrics		
		+		
054 silver gray	304 lipari		452 COOL taupe Cat. A	661 TWIST sand Cat. B

Fiber	Powder coating	Recommended fabrics		
		+		
149 basalt gray	317 black pepper		458 COOL ash Cat. A	683 MAR ash Cat. B

LOUNGE CHAIR

Sessel
Sillón bajo
Poltrona club
Fauteuil club
10,3 kg 0,25 m³



108005054



108005149

SEAT CUSHION + BACK CUSHION
Sitzkissen + Rückenkissen
Cojín de asiento + Cojín de respaldo
Cuscino sduta + Cuscino schienale
Coussin d'assise + Coussin de dossier
74 x 72 cm + 58 x 41 cm



108005

95108005

56108005000



PLUSH CUSHION
Plush Kissen
Plush cojín
Plush cuscino
Plush coussin

95108006

RECOMMENDED DECO CUSHIONS

Empfohlene Dekokissen
Cojines decoración recomendados
Cuscini decorativi consigliati
Coussins déco recommandés

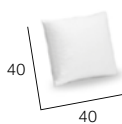

108005054

EN BELLMONDE furniture combines a powder-coated aluminum frame with woven DEDON Fiber. It comes with a seat consisting of sling material and two cushion options. The seat + back cushion version, with its clean lines and horizontal stitching detail on the front of the back cushion, provides sturdy sitting comfort. The plush version offers a cozier experience with softer lines. Shake the plush cushions occasionally to ensure maximum comfort. Plush cushion covers may be washed by hand at 30°C.

DE Die BELLMONDE Möbel sind aus DEDON-Faser gefertigt, die auf einen pulverbeschichteten Aluminiumrahmen geflochten ist. Der Sitz besteht aus Sling-Material. BELLMONDE ist in zwei unterschiedlichen Polster-Ausführungen erhältlich: Die Version mit Sitz- und Rückenkissen in geradliniger Anmutung mit waagrecht verlaufender Ziernaht auf der Vorderseite des Rückenkissens bietet einen festen Sitzkomfort. Ein komfortables Sitzgefühl mit weicheren Formen bietet die Ausführung mit Plush Kissen. Schütteln Sie die Plush Kissen regelmäßig auf, um maximalen Komfort zu erhalten. Die Plush-Kissenbezüge sind bei 30°C von Hand waschbar.

ES Los muebles de BELLMONDE están fabricados con fibra trenzada DEDON sobre una estructura de aluminio recubierto en polvo. Los asientos están compuestos de material de tensor y ofrecen dos opciones de cojín. El cojín de asiento y respaldo presenta líneas claras y una costura horizontal en la parte frontal del cojín de respaldo, lo cual aporta una estable confort al estar sentado. La versión plush cojín de asiento resulta todavía más acogedora por sus líneas más suaves. Sacudir el plush cojín de vez en cuando para garantizar la máxima comodidad. Las fundas de los plush cojines pueden lavarse a mano a 30°C.











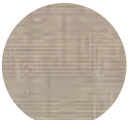

IT I mobili BELLMONDE sono realizzati in fibra DEDON intrecciata su un telaio in alluminio verniciato a polvere. Le sedute sono realizzate in fettuccia e offrono due opzioni di cuscino. La versione seduta + schienale, dalle linee pulite e dettaglio con impuntura orizzontale sulla parte anteriore del cuscino dello schienale, conferisce un comfort strutturato alla seduta. La versione plush offre un abbraccio più morbido e linee più delicate. Sprimacciare i cuscini felpati occasionalmente per garantire il massimo comfort. Le fodere dei cuscini plush sono lavabili a mano a 30°C.

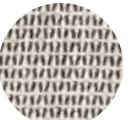



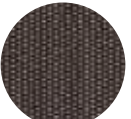
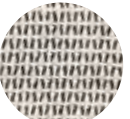

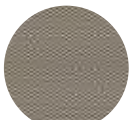
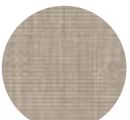
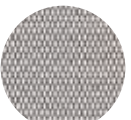







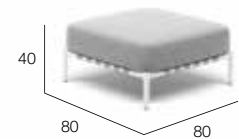

FR Les meubles BELLMONDE sont fabriqués en fibre DEDON, tressée sur un cadre en aluminium thermolaqué. Le siège est conçu en matériau sling et propose deux options de coussins. La version de coussin d'assise et de dossier, avec ses lignes épurées et ses coutures horizontales à l'avant du coussin de dossier, offre un solide confort d'assise. La version en peluche permet une expérience plus confortable avec ses lignes plus douces. Secouez les coussins en peluche de temps en temps pour assurer un confort maximal. Les housses des plush coussins peuvent être lavées à la main à 30°C.

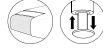

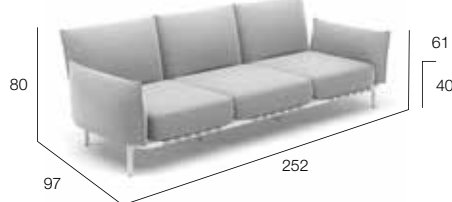
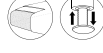
Lounge chair
3-seater
Cushion: PUNO reed
Coffee table 80 x 150 cm

Recommended combinations

	+					
000 white		452 COOL taupe Cat. A	661 TWIST sand Cat. B	678 Kvadrat patio450 Cat. B	696 PUNO reed Cat. C	693* SAIL CLOTH light gray Cat. B
	+					
317 black pepper		452 COOL taupe Cat. A	661 TWIST sand Cat. B	680 Kvadrat patio370 Cat. B	696 PUNO reed Cat. C	693* SAIL CLOTH light gray Cat. B
	+					
330 palm		452 COOL taupe Cat. A	661 TWIST sand Cat. B	675 Kvadrat patio220 Cat. B	695 PUNO straw Cat. C	693* SAIL CLOTH light gray Cat. B

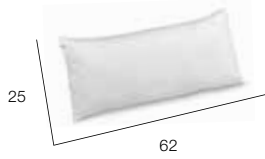
<p>LOUNGE CHAIR Sessel Sillón bajo Poltrona club Fauteuil club 24 kg 0,8 m³</p>	 <p>317</p>	 <p>80 97 102 61 40</p>	<p>DRY+ CUSHION SET Dry+ Kissenset Dry+ Set de cojines Dry+ Set di cuscini Dry+ Set de coussins</p>	
107001	330	107001000	95107001	56107001000
<p>FOOTSTOOL Hocker Taburete Pouf Repose-pieds 80 x 80 cm 8,3 kg 0,14 m³</p>	 <p>317</p>	 <p>40 80 80</p>	<p>DRY+ SEAT CUSHION Dry+ Sitzkissen Dry+ Cojín de asiento Dry+ Cuscino seduta Dry+ Coussin d'assise 80 x 80 x 20 cm</p>	
107031	330	107031000	95107031	56107031000
<p>2-SEATER 2er-Sofa Sofá 2 plazas Divano 2 posti Canapé 2 places 38 kg 1,4 m³</p>	 <p>317</p>	 <p>80 97 177 61 40</p>	<p>DRY+ CUSHION SET Dry+ Kissenset Dry+ Set de cojines Dry+ Set di cuscini Dry+ Set de coussins</p>	
107011	330	107011000	95107011	56107011000
<p>3-SEATER 3er-Sofa Sofá 3 plazas Divano 3 posti Canapé 3 places 53,5 kg 2 m³</p>	 <p>317</p>	 <p>80 97 252 61 40</p>	<p>DRY+ CUSHION SET Dry+ Kissenset Dry+ Set de cojines Dry+ Set di cuscini Dry+ Set de coussins</p>	
107021	330	107021000	95107021	56107021000
<p>DAYBED LEFT Daybed links Daybed izquierdo Daybed sinistro Daybed gauche 37 kg 1,4 m³</p>	 <p>317</p>	 <p>80 173,5 94,5 40</p>	<p>DRY+ CUSHION SET Dry+ Kissenset Dry+ Set de cojines Dry+ Set di cuscini Dry+ Set de coussins</p>	
107041	330	107041000	95107041	56107041000
<p>DAYBED RIGHT Daybed rechts Daybed derecho Daybed destro Daybed droit 37 kg 1,4 m³</p>	 <p>317</p>	 <p>40 94,5 173,5 80</p>	<p>DRY+ CUSHION SET Dry+ Kissenset Dry+ Set de cojines Dry+ Set di cuscini Dry+ Set de coussins</p>	
107042	330	107042000	95107042	56107042000
<p>RECOMMENDED DECO CUSHIONS Empfohlene Dekokissen Cojines decoración recomendados Cuscini decorativi consigliati Coussins déco recommandés</p>		 <p>25 62</p>		
		95050090		

* EN Fabrics for BREa Collection and deco cushions only.

DE Stoffe nur für BREa Kollektion und Dekokissen erhältlich.

ES Solo para la colección BREa y los cojines decorativos.

IT Tessuto disponibile solo per la collezione BREa e per i cuscini decorativi.

FR Tissu uniquement disponible pour la collection BREa et les coussins déco.

2-SEATER DAYBED LEFT

2er-Sofa, Daybed links

Sofá 2 plazas con daybed izquierdo

Divano 2 posti, daybed sinistro

Canapé 2 places, daybed gauche

55 kg 2,8 m³**317****330****107016000**

DRY+ CUSHION SET

Dry+ Kissenset

Dry+ Set de cojines

Dry+ Set di cuscini

Dry+ Set de coussins

**107016****95107016****56107016000****2-SEATER DAYBED RIGHT**

2er-Sofa, Daybed rechts

Sofá 2 plazas con daybed derecho

Divano 2 posti, daybed destro

Canapé 2 places, daybed droit

55 kg 2,8 m³**317****330****107017000**

DRY+ CUSHION SET

Dry+ Kissenset

Dry+ Set de cojines

Dry+ Set di cuscini

Dry+ Set de coussins

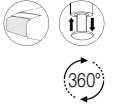
**107017****95107017****56107017000****DOUBLE DAYBED**

Doppel-Daybed

Daybed doble

Daybed matrimoniale

Daybed double

74 kg 2,65 m³**317****330****107043000**

DRY+ CUSHION SET

Dry+ Kissenset

Dry+ Set de cojines

Dry+ Set di cuscini

Dry+ Set de coussins

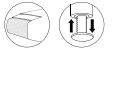
**107043****95107043****56107043000****3-SEATER DAYBED LEFT**

3er-Sofa, Daybed links

Sofá 3 plazas con daybed izquierdo

Divano 3 posti, daybed sinistro

Canapé 3 places, daybed gauche

80 kg 3,7 m³**317****330****107026000**

DRY+ CUSHION SET

Dry+ Kissenset

Dry+ Set de cojines

Dry+ Set di cuscini

Dry+ Set de coussins

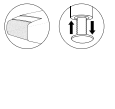
**107026****95107026****56107026000****3-SEATER DAYBED RIGHT**

3er-Sofa, Daybed rechts

Sofá 3 plazas con daybed derecho

Divano 3 posti, daybed destro

Canapé 3 places, daybed droit

80 kg 3,7 m³**317****330****107027000**

DRY+ CUSHION SET

Dry+ Kissenset

Dry+ Set de cojines

Dry+ Set di cuscini

Dry+ Set de coussins

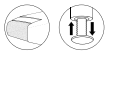
**107027****95107027****56107027000****CORNER SOFA**

Ecksofa

Sofá esquinero

Divano angolare

Canapé d'angle

106 kg 5,4 m³**317****330****107062000**

DRY+ CUSHION SET

Dry+ Kissenset

Dry+ Set de cojines

Dry+ Set di cuscini

Dry+ Set de coussins

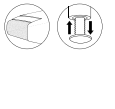
**107062****95107062****56107062000**

L-SOFA LEFT
 L-Sofa links
 Sofá en L izquierdo
 Divano a L, sinistro
 Canapé en L, gauche
 86 kg 3,7 m³

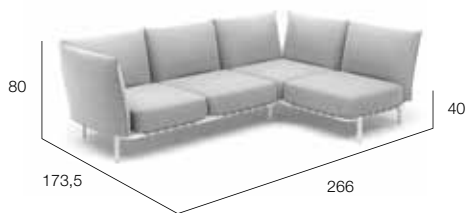

107060

330

107060000

DRY+ CUSHION SET
 Dry+ Kissenset
 Dry+ Set de cojines
 Dry+ Set di cuscini
 Dry+ Set de coussins



95107060

56107060000

L-SOFA RIGHT
 L-Sofa rechts
 Sofá en L derecho
 Divano a L, destro
 Canapé en L, droit
 86 kg 3,7 m³



107061

330

107061000

DRY+ CUSHION SET
 Dry+ Kissenset
 Dry+ Set de cojines
 Dry+ Set di cuscini
 Dry+ Set de coussins



95107060

56107061000

4-SEATER DAYBED LEFT
 4er-Sofa Daybed links
 Sofá 4 plazas con daybed izquierdo
 Divano 4 posti, daybed sinistro
 Canapé 4 places, daybed gauche
 97 kg 4,9 m³

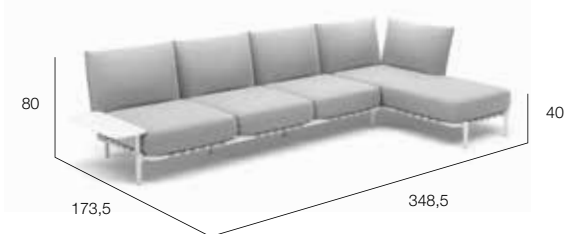

107056

330

107056000

DRY+ CUSHION SET
 Dry+ Kissenset
 Dry+ Set de cojines
 Dry+ Set di cuscini
 Dry+ Set de coussins



95107056

56107056000

4-SEATER DAYBED RIGHT
 4er-Sofa Daybed rechts
 Sofá 4 plazas con daybed derecho
 Divano 4 posti, daybed destro
 Canapé 4 places, daybed droit
 97 kg 4,9 m³



107057

330

107057000

DRY+ CUSHION SET
 Dry+ Kissenset
 Dry+ Set de cojines
 Dry+ Set di cuscini
 Dry+ Set de coussins



95107057

56107057000

CORNER SOFA XL LEFT
 Ecksofa XL links
 Sofá esquinero XL izquierdo
 Divano angolare XL, angolo a sinistra
 Canapé d'angle XL, gauche
 120 kg 7,7 m³



107063

330

107063000

DRY+ CUSHION SET
 Dry+ Kissenset
 Dry+ Set de cojines
 Dry+ Set di cuscini
 Dry+ Set de coussins



95107063

56107063000

CORNER SOFA XL RIGHT
 Ecksofa XL rechts
 Sofá esquinero XL derecho
 Divano angolare XL, angolo a destra
 Canapé d'angle XL, droite
 120 kg 7,7 m³



107064

330

107064000

DRY+ CUSHION SET
 Dry+ Kissenset
 Dry+ Set de cojines
 Dry+ Set di cuscini
 Dry+ Set de coussins



95107063

56107064000

COFFEE TABLE
 Kaffeetisch
 Mesa de centro
 Tavolino da salotto
 Table de salon
90 x 90 cm
 39 kg 0,29 m³



Set: 107033000

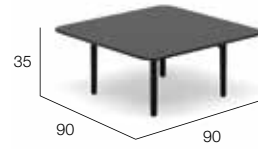

Set: 107033317



56107033000



Set: 107033330

107033

COFFEE TABLE
 Kaffeetisch
 Mesa de centro
 Tavolino da salotto
 Table de salon
80 x 150 cm
 49,5 kg 0,42 m³



Set: 107035000



Set: 107035317







56107035000

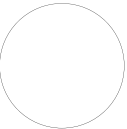

Set: 107035330

107035

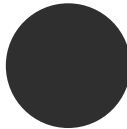
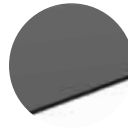
Combinations: tabletops mineral composite

Powder coating		Mineral composite		Powder coating		Mineral composite		Powder coating		Mineral composite
	+				+				+	
000 white		204 white		317 black pepper		203 ebony		330 palm		204 white

SEAT CUSHION

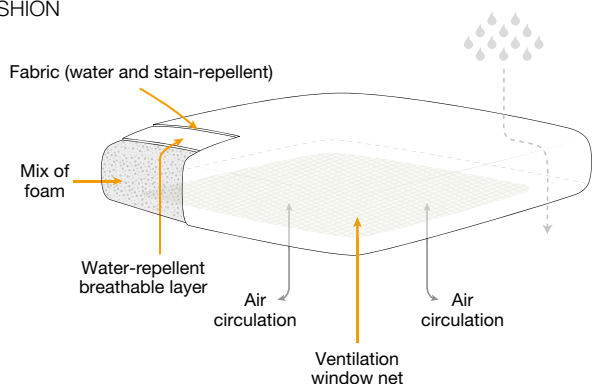

BACKREST & ARMREST

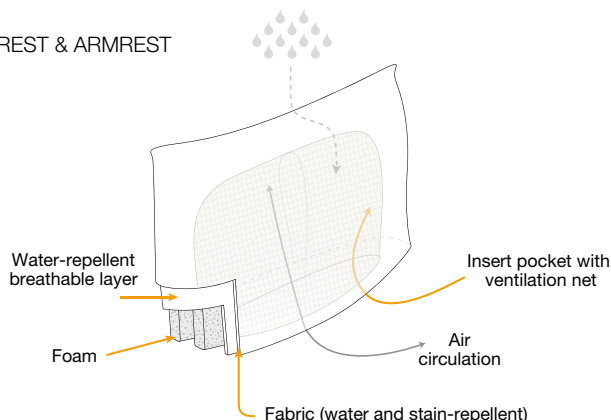

EN BREA is a comfortable and clever lounging collection with thoughtfully developed upholstery for indoor and outdoor use. Additionally, to configurations shown here, DEDON can create individual settings upon request. Please contact DEDON customer service.

BREA **cushions** can be easily slipped on and off of the metal frame. They are available in Cat. A, Cat. B (incl. Kvadrat PATIO) and Cat. C fabrics. Exclusively for BREA, cushions and deco cushions are available in sail cloth light gray fabric. Cushion covers can be removed. The cushions are protected by a water-repellent polyester covering. The fabric is treated to be stain- and water-repellent. If not used under roof or awning, we recommend covering the modules with DEDON outdoor covers at night and during rainfall.

BREA consists of a powdercoated **metal frame**, universal die-cast aluminum legs and connectors, and elastic outdoor belting in Sunbrella® yarns for enhanced comfort. All belting comes in a warm gray color.

The **tabletop** of the coffee tables and side tables consists of a self-supporting mineral-composite slab, cut by water jet from the largest premium sintered porcelain slabs available on the market. Clean the frame and tabletop with a soft cloth and warm water.

DE BREA ist eine komfortable und intelligente Lounging Kollektion mit durchdachten Polster-Elementen für den Innen- und Außenbereich. Zusätzlich zu den gezeigten Möbelkombinationen können individuelle Zusammenstellungen gewählt werden. Bitte wenden Sie sich hierfür an den DEDON Kundenservice.

Die **Polster-elemente** wirken fest verbaut, lassen sich bei Bedarf jedoch im Handumdrehen vom Rahmen herunternehmen. Erhältlich in Stoffen der Kategorien A, B (inklusive Kvadrat PATIO) und C, können die Kissenhüllen der Polster-elemente einfach abgezogen werden. Exklusiv erhältlich für BREA werden die Kissen und Dekokissen auch im Stoff sail cloth light gray angeboten. Die Kissen werden von einer wasserabweisenden Polyesterschicht geschützt. Der Stoff ist so behandelt, dass er schmutz- und wasserabweisend ist. Wenn Sie die Möbel nicht auf einer überdachten Fläche oder unter einer Markise aufstellen, empfehlen wir die Module nachts und bei Regen mit DEDON Husen zu schützen.

Das **Gestell** von BREA besteht aus pulverbeschichteten Aludruckgussbeinen und -verbindungen sowie einem pulverbeschichteten Metallrahmen. Elastische Outdoorriemen von Sunbrella® sorgen für noch mehr Komfort. Die Farbe der Riemen ist für alle Pulverbeschichtungen ein warmes grau.

Die **Tischplatten** der Kaffeetische und Beistelltische bestehen aus einem freitragenden Mineralverbundmaterial, das per Wasserstrahl aus den größten am Markt erhältlichen gesinterten Porzellanplatten geschnitten wird. Reinigen Sie den Rahmen und die Tischplatten mit einem weichen Tuch und warmem Wasser.

ES BREA es una colección de piezas lounge cómodas e inteligentes elaboradas con tapicería diseñada a conciencia tanto para uso interior como exterior. Además de las configuraciones que se muestran, DEDON también puede crear composiciones personalizadas bajo petición. Contacte con el Servicio de Atención al Cliente de DEDON.

Los **cojines** BREA pueden ponerse y quitarse fácilmente de la estructura metálica. Están disponibles en tejidos de las categorías A, B (incluyendo Kvadrat PATIO) y C. Exclusivamente para BREA, los cojines y cojines decorativos están disponibles en la tela sail cloth light gray. Las fundas de cojín se pueden quitar. El relleno de los cojines está protegido con un revestimiento impermeable de poliéster. La tela está tratada para ser resistente a las manchas y al agua. Si no se utiliza bajo techo o toldo, se recomienda cubrir los módulos con las fundas para exteriores DEDON por la noche y durante las lluvias.

La colección BREA está compuesta por **estructuras** de metal revestidas con pintura poliéster en polvo, patas y conectores de aluminio fundido y correas elásticas para exteriores de Sunbrella®, las cuales aportan un mayor confort. Todas las correas son de un color gris cálido.

Los **tableros de las mesas** de centro y mesas auxiliares están formados por una placa autoportante de compuesto mineral que ha sido cortada mediante chorro de agua a partir de placas de excelente porcelana sinterizada, las más grandes del mercado. Limpiar la estructura y el tablero con un paño suave y agua tibia.

IT BREA è una collezione lounging confortevole e intelligente, caratterizzata da elementi imbottiti appositamente concepiti per l'utilizzo in ambienti esterni e interni. Oltre alle configurazioni qui elencate, DEDON crea ambientazioni personalizzate su richiesta. Si prega di contattare il servizio clienti DEDON.

I **cuscini** BREA sono facilmente infilabili sulla struttura metallica e altrettanto facilmente rimovibili. Disponibili in tessuti Cat A, Cat B (incl. Kvadrat PATIO) e Cat C. I cuscini sono sfoderabili. In esclusiva per BREA, i cuscini e i cuscini decorativi sono disponibili in sail cloth light gray.

I cuscini sono protetti da una fodera in poliestere idrorepellente. Il tessuto viene trattato in modo da risultare resistente alla polvere e idrorepellente. Se non vengono utilizzati sotto tettoie o ripari, si consiglia di coprire i moduli con i teli da esterno DEDON durante la notte e in caso di pioggia.

BREA si compone di un **telaio** in metallo verniciato a polvere, gambe e connettori universali in alluminio pressofuso e fasce elastiche per esterno in tessuto Sunbrella® per un maggior comfort. Tutte le fasce sono caratterizzate da una tonalità di grigio caldo.

Il **piano dei tavolini** da salotto e dei tavolini d'appoggio è costituito da una lastra autoportante in minerale composito, tagliata a getto d'acqua e ricavata dalle più ampie lastre in porcellana sinterizzata di alta qualità disponibili sul mercato. Per la pulizia del telaio e il piano dei tavolini, utilizzare un panno morbido e acqua tiepida.

FR BREA est une collection confortable et bien pensée de lounge qui propose des revêtements et des éléments de rembourrage élaborés avec minutie pour une utilisation à l'intérieur comme à l'extérieur. En plus des combinaisons présentées, DEDON peut créer des configurations personnalisées sur demande. Veuillez contacter pour cela le service client de DEDON.

Les **coussins** BREA paraissent certes fixes, mais ils peuvent être retirés en toute simplicité du cadre en métal. Ils sont disponibles dans des tissus des catégories A, B (incl. Kvadrat PATIO) et C. Exclusivité BREA : les coussins et les coussins de décoration sont disponibles avec le tissu sail cloth light gray fabric. Les housses des coussins peuvent également être retirées. Le cœur de chaque module est protégé par une housse en polyester hydrofuge. Le tissu est traité pour être anti-tache et hydrofuge. Si les modules ne sont pas protégés par un toit ou un auvent, nous vous recommandons de les couvrir avec des housses d'extérieur DEDON pendant la nuit ou pendant les périodes de pluie.

BREA est composé de pieds et de raccords en aluminium moulé universel ainsi que d'un **cadre** en métal thermo-laqué. Des sangles outdoor élastiques de la marque Sunbrella® garantissent davantage de confort. Les sangles sont disponibles dans un gris chaleureux (warm gray).

Les **plateaux des tables** de salon et des tables d'appoint sont fabriqués dans un matériau minéral composite autoportant, lequel est découpé par jet hydraulique à partir des meilleures plaques de porcelaine frittées disponibles sur le marché. Nettoyez le cadre et le plateau de table avec chiffon doux et de l'eau chaude.

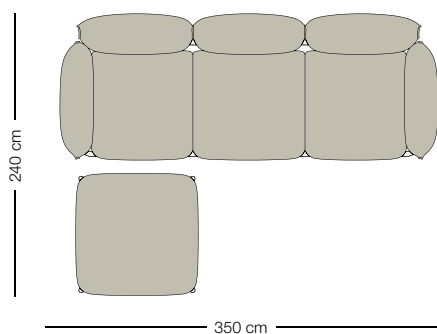

BREA Setting 01

- 1x 107021** 3-seater, Dry+ cushion set
- 1x 107031** Footstool, Dry+ seat cushion

Recommended deco cushions:

- 3x 95050090** – 25 x 62 cm
- 2x 95050082** – 50 x 50 cm
- 1x 95050081** – 40 x 40 cm

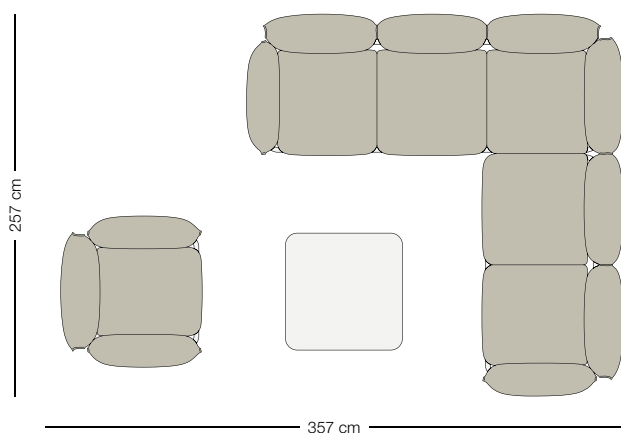

BREA Setting 02

- 1x 107062** – Corner sofa, Dry+ cushion set
- 1x 107001** – Lounge chair, Dry+ cushion set
- 1x 107033** – Coffee table 90 x 90 cm

Recommended deco cushions:

- 7x 95050090** – 25 x 62 cm
- 2x 95050082** – 50 x 50 cm
- 2x 95050081** – 40 x 40 cm

For inspiration please see DEDON Lookbook 2020, pages 62/63

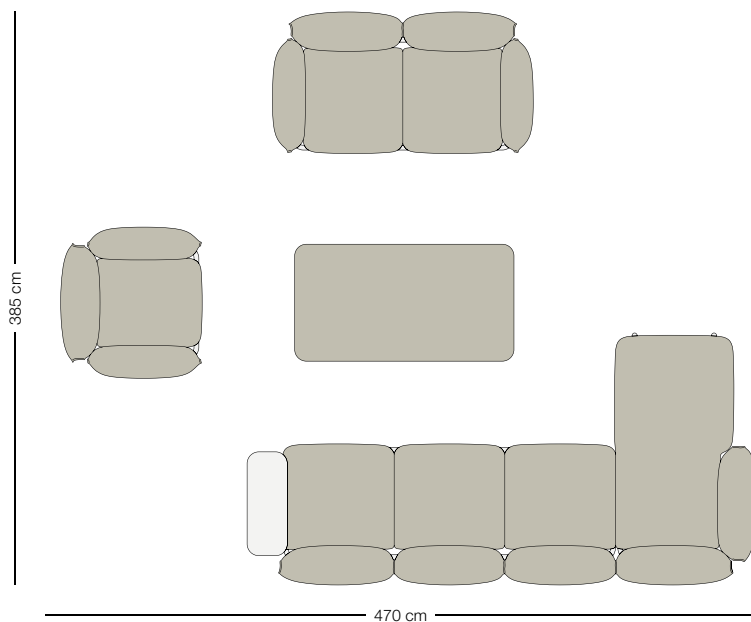

BREA Setting 03

- 1x 107011** – 2-Seater, Dry+ cushion set
- 1x 107001** – Lounge chair, Dry+ cushion set
- 1x 107035** – Coffee table 80 x 150 cm
- 1x 107057** – 4-Seater daybed right, Dry+ cushion set

Recommended deco cushions:

- 7x 95050090** – 25 x 62 cm
- 3x 95050082** – 50 x 50 cm
- 3x 95050081** – 40 x 40 cm







Lounge chair, black pepper
Dry+ cushion: Kvadrat patio370

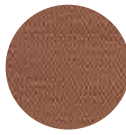
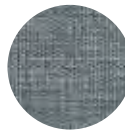

Sofa module M, PUNO straw
 Side table triangular, lipari
 Sofa module L, PUNO reed
 Module S, PUNO straw/reed
 Sofa module M, PUNO straw
 Side table triangular, lipari

Recommended fabrics for backrest round, backrest triangular, square cushion

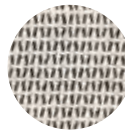
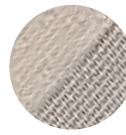
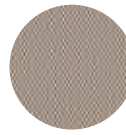
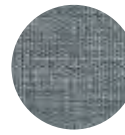
			+							+		
699 DUNE cove	698 DUNE shore	697 DUNE cove/shore		456 COOL marsala Cat. A	664 TWIST dark turquoise Cat. B		695 PUNO straw	696 PUNO reed	694 PUNO straw/reed		452 COOL taupe Cat. A	664 TWIST dark turquoise Cat. B

MODULE S

Modul S
Módulo S
Modulo S
Module S
95 x 95 cm
28 kg 0,4 m³



092016699



092016698

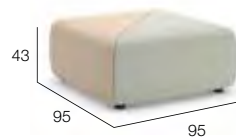

092016697



56092016000



092016695



092016696



092016694

SOFA MODULE CORNER LEFT

Sofa Eckmodul links
Módulo sofá esquina izquierdo
Divano modulo angolare sinistro
Canapé module d'angle gauche
98 x 98 cm
48,3 kg 0,69 m³



092019699



092019698

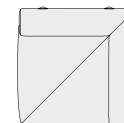

56092018000



092019695



092019696

SOFA MODULE CORNER RIGHT

Sofa Eckmodul rechts
Módulo sofá esquina derecho
Divano modulo angolare destro
Canapé module d'angle droit
98 x 98 cm
48,3 kg 0,69 m³



092018699



092018698

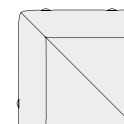

56092018000



092018695



092018696

EN BRIXX is only available in DUNE and PUNO fabric. Circle cushion is only available in DUNE cove/shore 697 and PUNO straw/reed 694. Sphere cushion is only available in COOL marsala 456.

DE BRIXX ist nur erhältlich in den Stoffen DUNE und PUNO. Das runde Kissen ist nur in DUNE cove/shore 697 und PUNO straw/reed 694 verfügbar. Das kugelförmige Kissen ist nur in COOL marsala 456 erhältlich.

ES BRIXX sólo se encuentra disponible en tejidos DUNE y PUNO. El cojín redondo sólo se encuentra disponible en cove/shore DUNE 697 y straw/reed PUNO 694. El cojín circular sólo se encuentra disponible en marsala COOL 456.

IT BRIXX è disponibile solo con i tessuti DUNE e PUNO. Il cuscino rotondo è disponibile soltanto con DUNE cove/shore 697 e PUNO straw/reed 694. Il cuscino sferico è disponibile in COOL marsala 456.

FR BRIXX est uniquement disponible avec les tissus DUNE et PUNO. Le coussin rond est uniquement disponible dans les variantes DUNE cove/shore 697 et PUNO straw/reed 694. Le coussin boule est uniquement disponible dans la variante COOL marsala 456.

SOFA MODULE S

Sofa Modul S
Módulo sofá S
Divano modulo S
Canapé Module S
98 x 95 cm
39,8 kg 0,67 m³



092017699



092017698



56092017000

092017



092017695



092017696

MODULE M

Modul M
Módulo M
Modulo M
Module M
95 x 160 cm
46,6 kg 0,7 m³



092013699



092013698



092013697



56092013000

092013



092013695



092013696



092013694

SOFA MODULE M

Sofa Modul M
Módulo sofá M
Divano modulo M
Canapé Module M
98 x 160 cm
60,3 kg 1,1 m³



092012699



092012698



56092012000

092012



092012695



092012696

BACKREST TRIANGULAR

Rückenlehne dreieckig
Respaldo triangular
Poggiaschiene triangolare
Dossier triangulaire
7,3 kg 0,05 m³

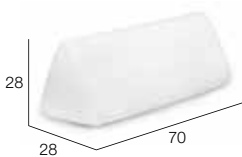

95092010

BACKREST ROUND

Rückenlehne rund
Respaldo redondo
Poggiaschiene a cilindro
Dossier rond
7,3 kg 0,05 m³

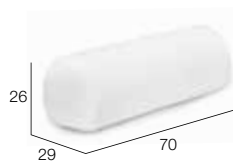

95092012

MODULE L

Modul L
Módulo L
Modulo L
Module L
95 x 190 cm
53,5 kg 0,78 m³



092014 092014699 092014698 092014697 56092014000



092014695 092014696 092014694

SOFA MODULE L

Sofa Modul L
Módulo sofá L
Divano modulo L
Canapé Module L
98 x 190 cm
70,7 kg 1,3 m³

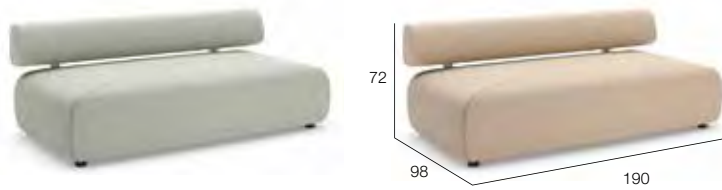

092015 092015699 092015698 56092015000



092015695 092015696

SIDE TABLE TRIANGULAR

Beistelltisch dreieckig
Mesa triangular
Tavolino triangolare
Table d'appoint triangulaire
17 kg 0,35 m³

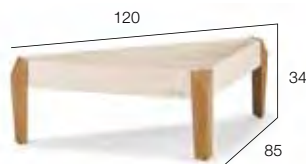

092035 092035098 56092035000

CIRCLE CUSHION

Kissen rund
Cojín redondo
Cuscino rotondo
Coussin rond



95092089697 95092089694

SQUARE CUSHION

Kissen viereckig
Cojín cuadrado
Cuscino quadrato
Coussin carré

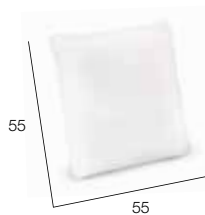

95092084

SPHERE CUSHION

Kissen kugelförmig
Cojín circular
Cuscino sferico
Coussin boule



95092085456

EN BRIXX is a comfortable, upholstered modular system for indoor and outdoor use. Its **structure** consists of a powder-coated steel frame encased in molded polyurethane foam, with belting for extra comfort.

The **core** of each module is protected by a water-repellent polyester covering.

The fabric is treated to be stain- and water-repellent. If not used under roof or awning, we recommend covering the modules with DEDON outdoor covers at night and during rainfall.

The **fabric** consists of 50% acrylic yarn and 50% recycled post-industrial acrylic yarn. Like all DEDON acrylic fabrics, those used for BRIXX are highly UV-resistant. The recycled yarn includes imperfections that give the fabric its very natural and appealing look.

The triangular and round **backrests** are equipped with a heavy core and anti-slip pads in order to give ideal support. The side table consists of a powder-coated aluminum top and natural teak legs.

DE BRIXX ist ein komfortables, gepolstertes Modulare System, das Sie sowohl im Innen- als auch im Außenbereich nutzen können. Die Möbel dieser Kollektion bestehen aus pulverbeschichteten **Stahlrahmen**, die mit formgeschäumtem Polyurethan-Schaum verkleidet sind. Riemen sorgen für noch mehr Komfort.

Der **Kern** jedes Moduls wird von einer wasserabweisenden Polyesterschicht geschützt. Der Stoff ist so behandelt, dass er schmutz- und wasserabweisend ist. Wenn Sie die Möbel nicht auf einer überdachten Fläche oder unter einer Markise aufstellen, empfehlen wir die Module nachts und bei Regen mit DEDON Husen zu schützen.

Der **Stoff** besteht zu 50% aus Acrylgarn und zu 50% aus recyceltem Acrylgarn. Wie alle DEDON Stoffe aus Acryl sind auch die Stoffe, die für BRIXX verwendet werden, extrem widerstandsfähig gegen UV-Strahlen. Das recycelte Garn zeichnet sich durch kleine Unregelmäßigkeiten aus, was dem Stoff einen sehr natürlichen und außergewöhnlichen Look verleiht.

Die dreieckigen und runden **Rückenlehnen** sind mit einem schweren Kern und rutschfestem Unterboden ausgestattet, wodurch sie ideal stützen. Der Beistelltisch wird aus pulverbeschichtetem Aluminium und Beinen aus naturbelassenem Teakholz gefertigt.

ES BRIXX es un cómodo sistema tapizado y modular de uso tanto en interiores como en exteriores. Su **estructura** consiste en un armazón de acero electro pintado recubierto con espuma moldeada de poliuretano, con cinturones para mayor comodidad.

El **núcleo** de cada módulo está protegido con un revestimiento impermeable de poliéster. La tela está tratada para ser resistente a las manchas y al agua. Si no se utiliza bajo techo o toldo, se recomienda cubrir los módulos con las fundas para exteriores DEDON por la noche y durante las lluvias.

El **tejido** se compone de fibras con un 50 % de acrílico y un 50 % de acrílico reciclado. Al igual que todos los tejidos acrílicos DEDON, los tejidos utilizados por BRIXX son también altamente resistentes a los rayos UV. La fibra reciclada incluye imperfecciones que dotan a la tela de un aspecto muy natural y atractivo.

Los **respaldos** triangulares y redondos están equipados con un pesado núcleo y textil antideslizante con el fin de proporcionar un soporte ideal. La mesa triangular consiste de un sobre de aluminio con acabado de pintura en polvo y patas de teca natural.

IT BRIXX è un sistema modulare imbottito e confortevole che si può usare sia all'interno che per all'esterno. La sua **struttura** si compone di un telaio in acciaio verniciato a polvere inserito in una schiuma poliuretana sagomata, con cinghie che assicurano il massimo comfort.

L'**anima** di ogni modulo è rivestita una custodia in poliestere idrorepellente. Il tessuto viene trattato in modo da risultare resistente alla polvere e idrorepellente. Se non vengono utilizzati sotto tettoie o ripari, si consiglia di coprire i moduli con i teli da esterno DEDON durante la notte e in caso di pioggia.

Il **tessuto** si compone al 50% di filato acrilico e al 50% di filato acrilico riciclato. Come tutti i tessuti acrilici di DEDON, anche i tessuti utilizzati per BRIXX sono estremamente resistenti ai raggi UV. Il filato acrilico presenta delle imperfezioni che gli conferiscono il suo aspetto naturale e piacevole.

I **poggiaschiena** a cilindro e triangolare sono dotati di un'anima pesante e di tappetini antiscivolo che permettono il sostegno ideale della schiena. Il tavolino d'appoggio si compone di un piano in alluminio verniciato a polvere e di gambe in teak naturale.

FR BRIXX est un système modulaire, confortable et capitonné, qui convient à une utilisation à l'intérieur comme à l'extérieur. Sa **structure** se compose d'un cadre en acier laqué encastré dans une mousse en polyuréthane moulé. Le tout est entouré d'une sangle pour un confort optimal.

Le **coeur** de chaque module est protégé par une housse en polyester hydrofuge. Le tissu est traité pour être anti-tache et hydrofuge. Si les modules ne sont pas protégés par un toit ou un auvent, nous vous recommandons de les couvrir avec des housses d'extérieur DEDON pendant la nuit ou pendant les périodes de pluie.

Les **tissus** sont composés de 50% de fils acryliques et de 50% de fils acryliques recyclés. Comme tous les tissus acryliques DEDON, les tissus qui équipent la collection Brix sont hautement résistants aux rayons UV. Les fils recyclés comportent des imperfections qui donnent au tissu un aspect très naturel et très attrayant.

Les **dossiers** triangulaires et ronds sont équipés d'une garniture épaisse et de coussinets antidérapants pour vous donner un soutien optimal. La table d'appoint est composée d'une plaque en aluminium laqué et de pieds en teck naturel.

DRY+ CUSHION CONSTRUCTION

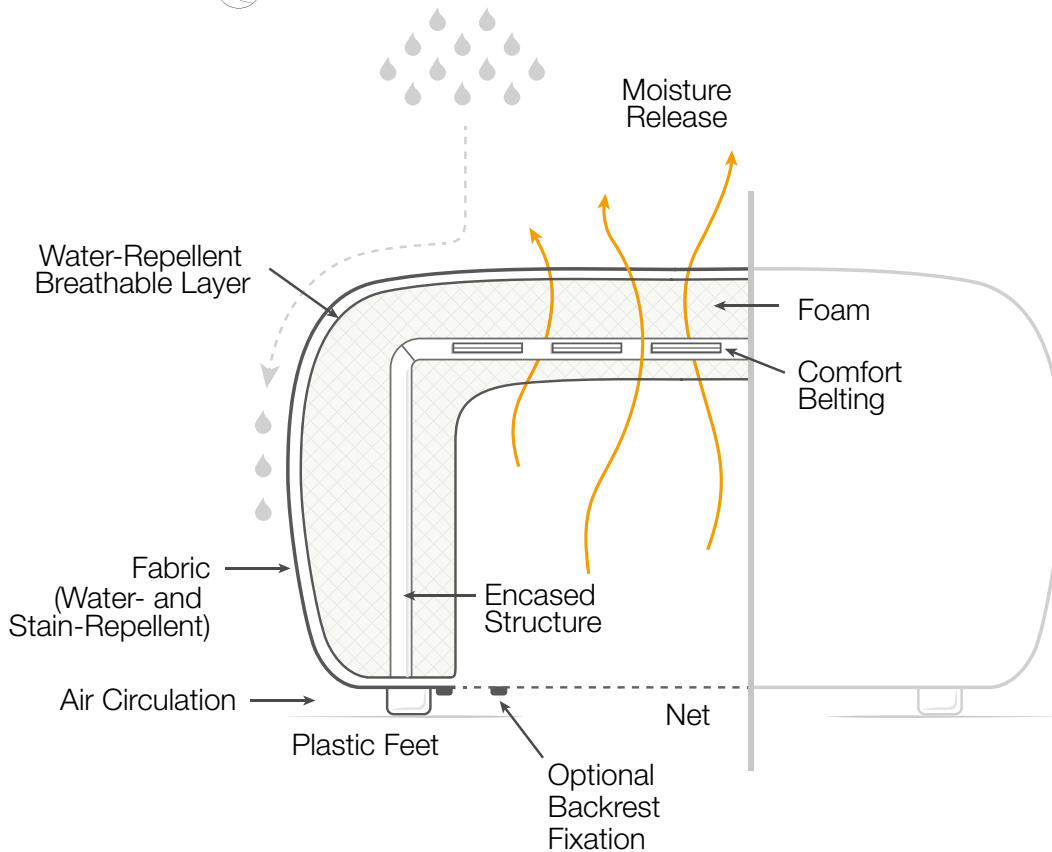

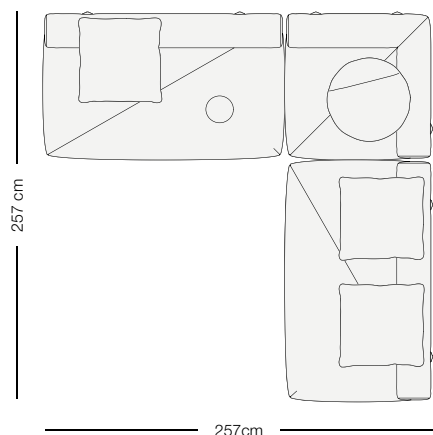

BRIXX Setting S

- 1x **092012** – Sofa module M + sphere cushion + square cushion
- 1x **092019** – Sofa corner module + circle cushion
- 1x **092012** – Sofa module M + square cushions

For inspiration please see DEDON Lookbook 2020, pages 55 and 124

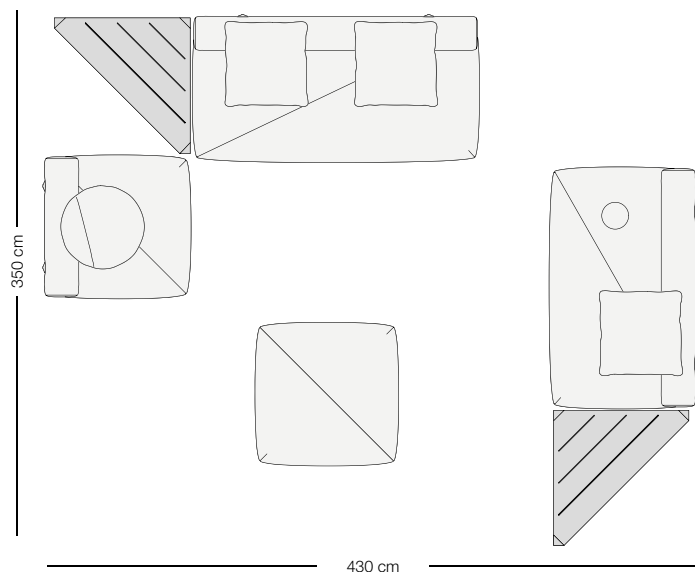

BRIXX Setting M

- 1x **092017** – Sofa module S + circle cushion
- 2x **092035** – Side table triangular
- 1x **092015** – Sofa module L + square cushions
- 1x **092016** – Module S
- 1x **092012** – Sofa module M + sphere cushion + square cushion

For inspiration please see page 36

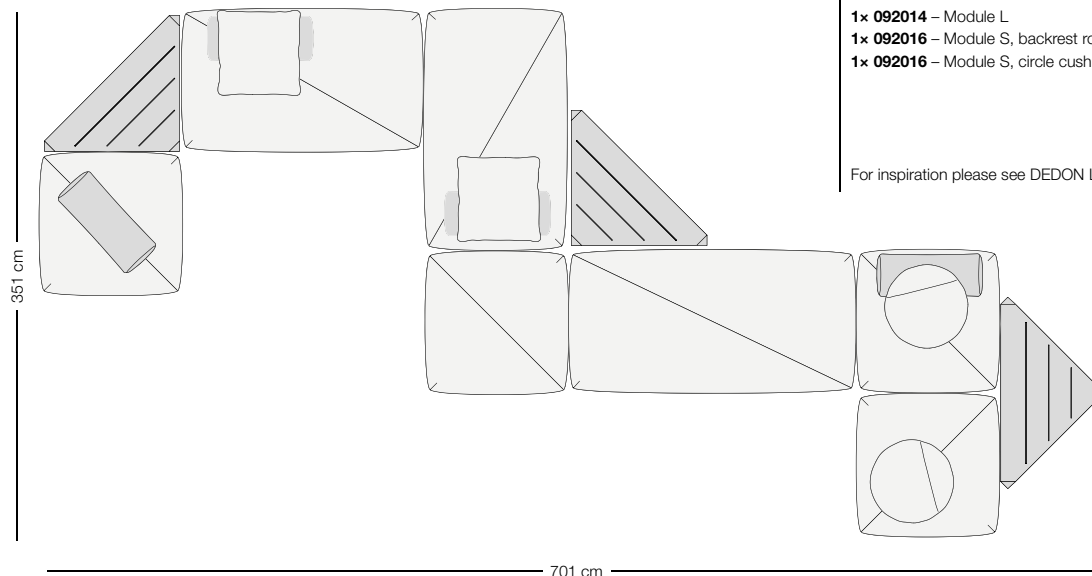

BRIXX Setting L

- 1x **092016** – Module S, backrest round
- 3x **092035** – Side table triangular
- 2x **092013** – Module M, backrest triangular + square cushion
- 1x **092016** – Module S
- 1x **092014** – Module L
- 1x **092016** – Module S, backrest round + circle cushion
- 1x **092016** – Module S, circle cushion

For inspiration please see DEDON Lookbook 2020, pages 52/53



Recommended combinations

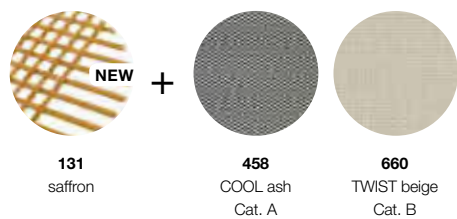
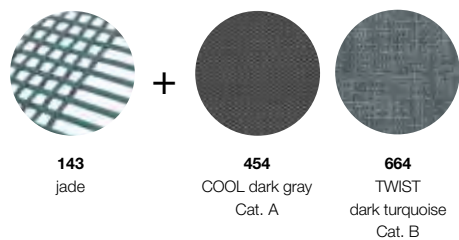
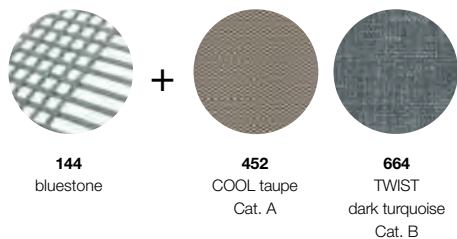
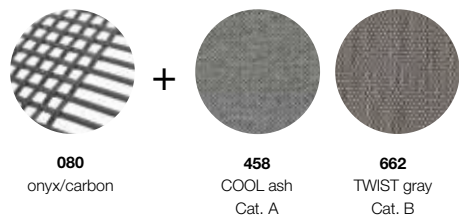

ARMCHAIR, CENTRAL BASE
 Armlehnstuhl, Standfuß
 Silla con brazos, base central
 Poltrona pranzo, base piedistallo
 Fauteuil repas, pied central
 4,9 kg 0,29 m³

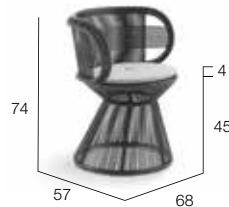

SEAT CUSHION
 Sitzkissen
 Cojín de asiento
 Cuscino seduta
 Coussin d'assise
 Ø 48 cm



104002

104002080

95104001

56104002000



104002144



104002143



104002131

ARMCHAIR
 Armlehnstuhl
 Silla con brazos
 Poltrona pranzo
 Fauteuil repas
 3,9 kg 0,29 m³

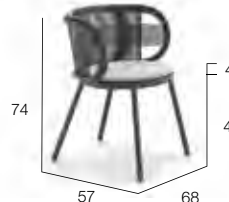

SEAT CUSHION
 Sitzkissen
 Cojín de asiento
 Cuscino seduta
 Coussin d'assise
 Ø 48 cm



104001

104001080

95104001

56104001000



104001144

EN CIRQL furniture consists of DEDON Fiber woven over a powder coated aluminum frame. The tabletops of the side tables are made of metal that has been powder coated in a color corresponding to that of the fiber. Clean with a soft cloth and warm water.

DE Die CIRQL Möbel sind aus DEDON-Faser gefertigt, die auf einem pulverbeschichteten Aluminiumrahmen geflochten ist. Die Tischplatten der Beistelltische bestehen aus pulverbeschichtetem Metall passend zur Farbe der DEDON-Faser. Einfach mit einem weichen Tuch und warmem Wasser zu reinigen.

ES Los muebles de CIRQL están fabricados con fibra trenzada DEDON sobre una estructura de aluminio recubierto en polvo. Los tableros de las mesas auxiliares están hechos con metal recubierto en polvo que combina con el color de la fibra. Limpiar con un paño suave y agua tibia.

IT I mobili CIRQL sono realizzati in fibra DEDON intrecciata su un telaio in alluminio verniciato a polvere. I piani dei tavolini d'appoggio sono realizzati in metallo verniciato a polvere nel colore corrispondente a quello della fibra. Pulire con un panno morbido e acqua tiepida.

FR Les meubles CIRQL se composent de fibre DEDON tressée sur un cadre en aluminium thermolaqué. Les plateaux des tables d'appoint sont en métal thermolaqué assorti à la couleur de la fibre DEDON. Nettoyer avec un chiffon doux et de l'eau chaude.

ARMCHAIR
 Armlehnstuhl
 Silla con brazos
 Poltrona pranzo
 Fauteuil repas
 3,9 kg 0,29 m³



104001143



SEAT CUSHION
 Sitzkissen
 Cojín de asiento
 Cuscino seduta
 Coussin d'assise
 Ø 48 cm



104001

95104001

56104001000



104001131



LOUNGE CHAIR
 Sessel
 Sillón bajo
 Poltrona club
 Fauteuil club
 4,6 kg 0,49 m³



104003080



SEAT CUSHION
 Sitzkissen
 Cojín de asiento
 Cuscino seduta
 Coussin d'assise
 Ø 63 cm



104003

95104003

56104003000



104003144



104003143



104003131



STOOL
 Hocker
 Asiento
 Pouf
 Tabouret
 3,1 kg 0,1m³



104004**080**



SEAT CUSHION
 Sitzkissen
 Cojín de asiento
 Cuscino seduta
 Coussin d'assise
 Ø 48 cm



104004

95104001

56104004000



104004**144**



104004**143**



104004**131**



SIDE TABLE
 Beistelltisch
 Mesa auxiliar
 Tavolino d'appoggio
 Table d'appoint
 3,1 kg 0,1m³



Set: 104036**080**

TABLETOP
 Tischplatte
 Tablero
 Top dei tavoli
 Plateau de table
 2 kg

104033**080**



Set: 104036**143**

TABLETOP
 Tischplatte
 Tablero
 Top dei tavoli
 Plateau de table
 2 kg

104033**133**



104004

56104004000



Set: 104036**144**

TABLETOP
 Tischplatte
 Tablero
 Top dei tavoli
 Plateau de table
 2 kg

104033**144**



Set: 104036**131**

TABLETOP
 Tischplatte
 Tablero
 Top dei tavoli
 Plateau de table
 2 kg

104033**131**

Tabletops powder coated metal



329
black



144
bluestone



131
saffron



133
nori



Lounge chair
Coffee table ø 89 cm
Stool ø 46 cm

Combinations

Fiber	Powder coating	Fabric		Fiber	Powder coating	Fabric		Fiber	Powder coating	Fabric
			+				+			
532 fire	329 black	735 aubergine		533 grass	076 green	761 noisette/grass		534 stone	099 vulcano	762 noisette/stone

LOUNGE CHAIR
Sessel
Sillón bajo
Poltrona club
Fauteuil club
9,3 kg 0,72 m³



SEAT CUSHION
Sitzkissen
Cojín de asiento
Cuscino seduta
Coussin d'assise
ø 88 cm

BACK CUSHION
Rückenkissen
Cojín de respaldo
Cuscino schienale
Coussin de dossier
50 x 40 cm



073005

Set: 073006532 *

95073037735

95073005735

56073005000

LOUNGE CHAIR
Sessel
Sillón bajo
Poltrona club
Fauteuil club
9,3 kg 0,72 m³



SEAT CUSHION
Sitzkissen
Cojín de asiento
Cuscino seduta
Coussin d'assise
ø 88 cm

BACK CUSHION
Rückenkissen
Cojín de respaldo
Cuscino schienale
Coussin de dossier
50 x 40 cm



073005

Set: 073006533 *

95073037761

95073005761

56073005000

LOUNGE CHAIR
Sessel
Sillón bajo
Poltrona club
Fauteuil club
9,3 kg 0,72 m³



SEAT CUSHION
Sitzkissen
Cojín de asiento
Cuscino seduta
Coussin d'assise
ø 88 cm

BACK CUSHION
Rückenkissen
Cojín de respaldo
Cuscino schienale
Coussin de dossier
50 x 40 cm



073005

Set: 073006534 *

95073037762

95073005762

56073005000

RECOMMENDED DECO CUSHIONS, FIRE
Empfohlene Dekokissen, fire
Cojines decoración recomendados, fire
Cuscini decorativi consigliati, fire
Coussins déco, fire, recommandés
ø 40 cm LINEN sand, 50 x 50 cm LINEN taupe



RECOMMENDED DECO CUSHIONS, GRASS
Empfohlene Dekokissen, grass
Cojines decoración recomendados, grass
Cuscini decorativi consigliati, grass
Coussins déco, grass, recommandés
ø 40 cm LINEN sand, 50 x 50 cm COOL taupe



RECOMMENDED DECO CUSHIONS, STONE
Empfohlene Dekokissen, stone
Cojines decoración recomendados, stone
Cuscini decorativi consigliati, stone
Coussins déco, stone, recommandés
ø 40 cm LINEN sand, 50 x 50 cm LINEN warm gray

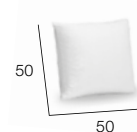
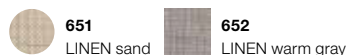

95050088651, 95050082640

95050088651, 95050082452

95050088651, 95050082652

LOVESEAT
Sofainsel
Sofá isla
Isola 2 posti
L'îlot câlin
ø 179 cm
30 kg 2,51 m³



SEAT CUSHION
Sitzkissen
Cojín de asiento
Cuscino seduta
Coussin d'assise
ø 165 cm



073004

073004532

95073014735

56073004000

LOVESEAT
Sofainsel
Sofá isla
Isola 2 posti
L'îlot câlin
ø 179 cm
30 kg 2,51 m³



SEAT CUSHION
Sitzkissen
Cojín de asiento
Cuscino seduta
Coussin d'assise
ø 165 cm



073004

073004533

95073014761

56073004000

LOVESEAT
Sofainsel
Sofá isla
Isola 2 posti
L'îlot câlin
ø 179 cm
30 kg 2,51 m³



SEAT CUSHION
Sitzkissen
Cojín de asiento
Cuscino seduta
Coussin d'assise
ø 165 cm



073004

073004534

95073014762

56073004000

* EN Set includes lounge chair, seat cushion and back cushion. DE Das Set beinhaltet den Sessel, das Sitz- sowie das Rückenkissen. ES „Set“ incluye un sillón bajo, con su cojín de asiento y de respaldo. IT Il set include una poltrona, un cuscino seduta e un cuscino schienale. FR Le set comprend le fauteuil club, le coussin d'assise et le coussin de dossier.

RECOMMENDED DECO CUSHIONS

Empfohlene Dekokissen

Cojines decoración recomendados

Cuscini decorativi consigliati

Coussins déco recommandés

2x 70 x 70 cm TWIST gray 662

2x 60 x 60 cm LINEN warm gray 652

1x 50 x 50 cm LINEN off white 650, 1x 40 x 40 cm COOL white 450

2x 95050086662, 2x 95050084652,

1x 95050082650, 1x 95050081450

662
TWIST gray

652
LINEN warm gray

650
LINEN off white

450
COOL white

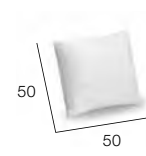
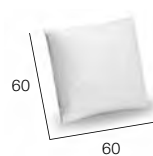
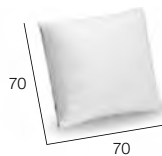

EN The Loveseat is shipped with pre-mounted pullout casters. **DE** Die Sofainself wird inkl. vormontierter ausklappbarer Räder geliefert. **ES** El sofá isla se entrega con ruedas premontadas plegables. **IT** L'isola viene fornita completa di ruote pieghevoli. **FR** L'îlot câlin est fourni avec des roues pré-montées escamotables.



STOOL / SIDE TABLE

Hocker / Beistelltisch

Asiento / Mesa auxiliar

Pouf / Tavolino d'appoggio

Tabouret / Table d'appoint

ø 46 cm

4,5 kg 0,16 m³



073035532

SEAT CUSHION

Sitzkissen

Cojín de asiento

Cuscino seduta

Coussin d'assise

ø 43 cm



95073033735

Set: 073036532

GLASS FIRE

Glas fire

Sobre de cristal fire

Piano in vetro fire

Plaque en verre fire

2,3 kg



22273033313

56073035000

STOOL / SIDE TABLE

Hocker / Beistelltisch

Asiento / Mesa auxiliar

Pouf / Tavolino d'appoggio

Tabouret / Table d'appoint

ø 46 cm

4,5 kg 0,16 m³

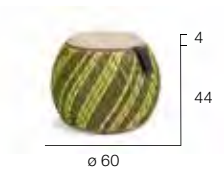

073035533

SEAT CUSHION

Sitzkissen

Cojín de asiento

Cuscino seduta

Coussin d'assise

ø 43 cm



95073033761

Set: 073036533

GLASS GRASS

Glas grass

Sobre de cristal grass

Piano in vetro grass

Plaque en verre grass

2,3 kg



22273033312

56073035000

STOOL / SIDE TABLE

Hocker / Beistelltisch

Asiento / Mesa auxiliar

Pouf / Tavolino d'appoggio

Tabouret / Table d'appoint

ø 46 cm

4,5 kg 0,16 m³



073035534

SEAT CUSHION

Sitzkissen

Cojín de asiento

Cuscino seduta

Coussin d'assise

ø 43 cm



95073033762

Set: 073036534

GLASS STONE

Glas stone

Sobre de cristal stone

Piano in vetro stone

Plaque en verre stone

2,3 kg



22273033314

56073035000

FOOTSTOOL / COFFEE TABLE

Hocker / Kaffeetisch

Taburete / Mesa de centro

Pouf / Tavolino da salotto

Repose-pieds / Table de salon

ø 89 cm

6,7 kg 0,29 m³



073037532

SEAT CUSHION

Sitzkissen

Cojín de asiento

Cuscino seduta

Coussin d'assise

ø 88 cm



95073037735

Set: 073038532

GLASS FIRE

Glas fire

Sobre de cristal fire

Piano in vetro fire

Plaque en verre fire

10,3 kg



22273037313

56073037000

FOOTSTOOL / COFFEE TABLE

Hocker / Kaffeetisch

Taburete / Mesa de centro

Pouf / Tavolino da salotto

Repose-pieds / Table de salon

ø 89 cm

6,7 kg 0,29 m³



073037533

SEAT CUSHION

Sitzkissen

Cojín de asiento

Cuscino seduta

Coussin d'assise

ø 88 cm



95073037761

Set: 073038533

GLASS GRASS

Glas grass

Sobre de cristal grass

Piano in vetro grass

Plaque en verre grass

10,3 kg



22273037312

56073037000

FOOTSTOOL / COFFEE TABLE

Hocker / Kaffeetisch
 Taburete / Mesa de centro
 Pouf / Tavolino da salotto
 Repose-pieds / Table de salon
ø 89 cm
 6,7 kg 0,29 m³



ø 96

SEAT CUSHION

Sitzkissen
 Cojín de asiento
 Cuscino seduta
 Coussin d'assise
 ø 88 cm



GLASS STONE

Glas stone
 Sobre de cristal stone
 Piano in vetro stone
 Plaque en verre stone
 10,3 kg



073037

073037534

95073037762

Set: 073038534

22273037314

56073037000

Tabletops glass

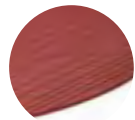

313 fire

Top: satinated stripes
 Bottom: lacquered in fire



312 grass

Top: satinated stripes
 Bottom: lacquered in grass



314 stone

Top: satinated stripes
 Bottom: lacquered in stone

EN The **swiveling table** of the DALA loveseat consists of a powder coated aluminum post and a tabletop of cross-laminated premium teak veneer.

The **DALA cushions** are covered with sophisticated Batyline® fabric, produced with a special quilting technique that reflects the design of the furniture itself. For the best-matching deco-cushions, we recommend our selection of acrylic fabrics (see 'recommended deco-cushions'). As an alternative, cushions made out of our standard fabrics are available upon request.

DE Der **Schwenktisch** der DALA Sofainsel besteht aus einer pulverbeschichteten Aluminiumhalterung und einer Tischplatte aus hochwertigem Teak-Schichtholz.

Die **DALA Kissenhüllen** sind aus Batyline®-Stoff gefertigt, einem Material, das höchsten Ansprüchen gerecht wird. Die Kissen werden in einer speziellen Quilt-Technik vernäht, die das Design des Möbels widerspiegelt. Als Dekokissen empfehlen wir unsere Acryl-Stoffe (siehe „empfohlene Dekokissen“). Kissen in unseren Standardstoffen sind auf Anfrage erhältlich.

ES La **mesa giratoria** integrada en el DALA sofá isla está hecha de aluminio revestido con pintura poliéster en polvo altamente resistente y un tablero de chapa de madera de teca laminada de la mejor calidad.

Los **cojines DALA** están cubiertos con el sofisticado tejido Batyline®, confeccionados con una técnica especial de confección de acolchado que refleja el diseño del mismo mobiliario. Para conseguir los mejores cojines decorativos a juego, recomendamos nuestra selección de tejidos de acrílico (véanse los "cojines decorativos recomendados"). Como alternativa, los cojines hechos con nuestros tejidos estándar están disponibles bajo pedido.

IT Il **tavolino girevole** dell' isola 2 posti DALA è composto da una base in alluminio verniciato a polvere e da un piano con impiallacciatura in teak di ottima qualità.

I **cuscini DALA** sono rivestiti con il raffinato tessuto Batyline®, prodotto con una speciale tecnica di trapuntatura che si richiama al design del mobile stesso. Per abbinare al meglio i cuscini decorativi consigliamo la nostra selezione di tessuti acrilici (si veda la sezione "cuscini decorativi"). In alternativa, i cuscini decorativi realizzati con i nostri tessuti standard sono disponibili su richiesta. Il vaso interno estraibile è fabbricato in polietilene rotostampato.

FR La **tablette pivotante** de l'îlot câlin DALA est constituée d'une structure en aluminium thermolaqué et d'un plateau en teck contreplaqué de qualité supérieure.

Les **coussins DALA** sont recouverts de tissu Batyline®, confectionnés avec une technique spéciale de matelassage qui fait écho au design du meuble. Notre sélection de textiles acryliques vous aidera à trouver les meilleurs coussins assortis au mobilier (voir « coussins déco conseillés »). La confection de coussins dans l'une de nos matières standard, est proposée sur commande uniquement.



Lounge chair
Armchair

Combinations

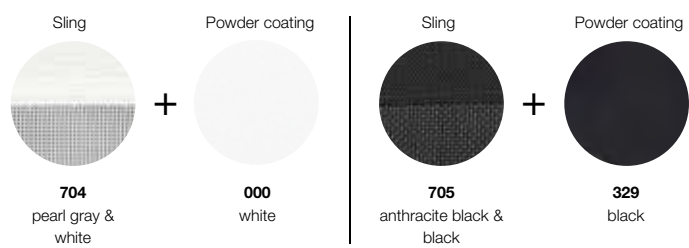

ARMCHAIR
Armlehnstuhl
Silla con brazos
Poltrona pranzo
Fauteuil repas
11 kg 0,29 m³



801001704



802001705

56800001000

LOUNGE CHAIR
Sessel
Sillón bajo
Poltrona club
Fauteuil club
11 kg 0,3 m³



801005704



802005705

56800005000

Complementary tables



SEAX Dining table teak/white
100 x 220 cm
See page 141



SEAX Coffee table ebony/black
ø 110 cm
See page 143



SATELLITE Side table white
ø 40 cm
See page 125

OPTIONAL COMBINATIONS

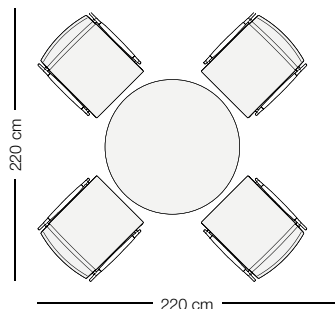

DEAN MEETS SEAX LOUNGE SETTING

1x 702036 – SEAX Coffee table Ø 110 cm, ebony/black
4x 801005 – DEAN Lounge chair

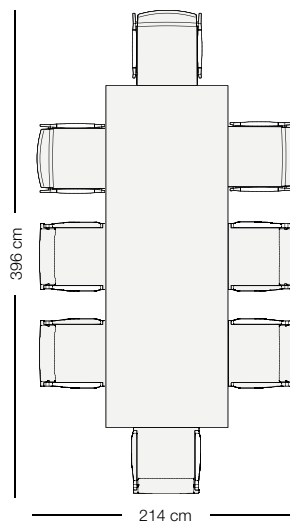

DEAN MEETS SEAX DINING SETTING

1x 702040 – SEAX Dining table 100 x 220 cm, teak
5x 702311 – SEAX Armchair
3x 802001 – DEAN Armchair

EN DEAN's frame is made of powder coated aluminum. Its seat and back consist of textile in a mix of PVC and PES. Clean frame, seat and backrest with a soft cloth and warm water. Clean natural-teak armrest inlays with a damp cloth, and do not apply cleaning detergents of any kind.

DE Der Rahmen von DEAN besteht aus pulverbeschichtetem Aluminium. Das Gewebe der Sitzfläche und der Rückenlehne ist eine Mischung aus PVC und Polyester. Reinigen Sie den Rahmen, die Sitzfläche und die Rückenlehne mit einem weichen Tuch und warmem Wasser. Die Einlage in den Armlehnen besteht aus naturbelas-senem Teakholz. Diese reinigen Sie mit einem feuchten Tuch und keinesfalls mit Reinigungsmitteln.

ES El armazón de DEAN está hecho de aluminio de fundición revestido de pintura en polvo. Su asiento y respaldo constan de un tejido mezcla de PVC y PES. Limpie la estructura, asiento y respaldo con un paño suave y agua tibia. Limpie las incrustaciones en los reposabrazos de teca natural con un paño húmedo y no aplique detergentes limpiadores de ningún tipo.

IT Il telaio di DEAN è realizzato in alluminio verniciato a polvere. La seduta e lo schienale sono in un tessuto sintetico composto da PVC e PES. Pulire il telaio, la seduta e lo schienale con un panno morbido e acqua calda. Pulire gli inserti in teak naturale sui braccioli con un panno umido, senza applicare detergenti di alcun tipo.





FR Le cadre de DEAN est fabriqué en aluminium laqué. Le siège et le dossier ont été créés dans un mélange de PVC et de polyester. Nettoyez le cadre, le siège et le dossier avec un chiffon doux et de l'eau chaude. Nettoyez les insertions des accoudoirs en teck naturel avec un chiffon humide. N'utilisez jamais de détergents.







Coffee table 50 x 90 cm, black pepper/lava
 Coffee table 80 x 80 cm, black pepper/pierre blue

Frames*

Powder coating

			
304 lipari	317 black pepper	133 nori	084 terracotta

Tabletops*

Glass		Natural stone
		
133 nori	084 terracotta	342 pierre blue
Mineral composite		HPL
		
343 talc	344 lava	306 lipari 2.0
		
		305 vulcano

*Please see collection overview for selected frame & tabletop combinations.

SIDE TABLE

Beistelltisch
Mesa auxiliar
Tavolino d'appoggio
Table d'appoint

39 x 39 cm



nori/glass nori
929010**133**



terracotta/glass terracotta
926010**084**

7,3 kg 0,08 m²



56900010000



lipari/HPL lipari 2.0
913010**306**



black pepper/HPL vulcano
917010**305**

5,6 kg 0,08 m²

SIDE TABLE

Beistelltisch
Mesa auxiliar
Tavolino d'appoggio
Table d'appoint

ø 54,5 cm



nori/glass nori
929020**133**



terracotta/glass terracotta
926020**084**

8,5 kg 0,14 m²



56900020000



lipari/HPL lipari 2.0
913020**306**



black pepper/HPL vulcano
917020**305**

6,3 kg 0,14 m²

COFFEE TABLE

Kaffeetisch
Mesa de centro
Tavolino da salotto
Table de salon

ø 111 cm



lipari/talc
933050**343**



black pepper/lava
937050**344**

29 kg 0,34 m²



56900050000



lipari/HPL lipari 2.0
913050**306**



black pepper/HPL vulcano
917050**305**

16,4 kg 0,734 m²

COFFEE TABLE

Kaffeetisch
Mesa de centro
Tavolino da salotto
Table de salon
80 x 80 cm



lipari/talc
933030**343**

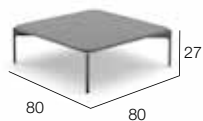

black pepper/lava
937030**344**

21,9 kg 0,18 m²



56900030000



black pepper/pierre blue
937030**342**

37 kg 0,18 m²



lipari/HPL lipari 2.0
913030**306**



vulcano HPL
917030**305**

12,6 kg 0,18 m²

COFFEE TABLE

Kaffeetisch
Mesa de centro
Tavolino da salotto
Table de salon
120 x 120 cm



lipari/talc
933040**343**

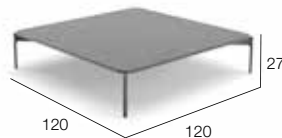

black pepper/lava
937040**344**

44,6 kg 0,39 m²



56900040000



lipari/HPL lipari 2.0
913040**306**



black pepper/HPL vulcano
917040**305**

24,1 kg 0,39 m²

COFFEE TABLE

Kaffeetisch
Mesa de centro
Tavolino da salotto
Table de salon
50 x 90 cm



lipari/talc
933060**343**

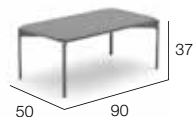

black pepper/lava
937060**344**

15,8 kg 0,17 m²



56900060000



lipari/HPL lipari 2.0
913060**306**



black pepper/HPL vulcano
917060**305**

9,9 kg 0,17 m²

COFFEE TABLE

Kaffeetisch
Mesa de centro
Tavolino da salotto
50 x 130 cm



lipari/talc
933070**343**

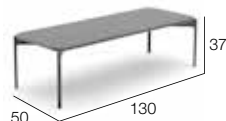

black pepper/lava
937070**344**

22,1 kg 0,28 m²



58900070000



lipari/HPL lipari 2.0
913070**306**



black pepper/HPL vulcano
917070**305**

12,9 kg 0,28 m²

EN Over time, the IZON tabletop in pierre blue, a natural stone, will change from black to matte gray.

DE Im Verlauf der Zeit verändert sich die Farbe der Natursteintischplatte pierre blue von schwarz zu einem matten Grauton.

ES Con el tiempo, el tablero IZON en pierre blue, una piedra natural, pasa de negro a gris mate.

IT Con il passare del tempo, il colore nero del piano del tavolo IZON in pietra naturale pierre blue, cambierà colore diventando grigio opaco.

FR Au fil du temps, le plateau de la table IZON en coloris 'pierre blue', rappelant la pierre naturelle, passera du noir au gris mat.



Before -
Natural stone
pierre blue,
black and shiny
surface



After -
Natural stone
pierre blue,
gray and
matte surface



IZON Setting 01

1x **937060344** – Coffee table, 50 x 90 cm, black pepper/lava
 1x **926010084** – Side table, 39 x 39 cm, terracotta/glass terracotta



IZON Setting 02

1x **913070306** – Coffee table, 50 x 130 cm, lipari/HPL lipari 2.0
 1x **913020306** – Side table, ø 54,5 cm, lipari/HPL lipari 2.0

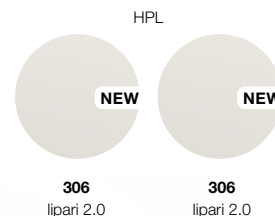

IZON Setting 03

1x **933050343** – Coffee table, ø 111 cm, lipari/talc
 1x **929020133** – Side table, ø 54,5 cm, nori/glass nori

For inspiration please see page 57



IZON Setting 04

1x **937030342** – Coffee table, 80 x 80 cm, black pepper/pierre blue
 1x **937060344** – Coffee table, 50 x 90 cm, black pepper/lava

For inspiration please see page 52

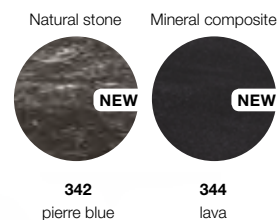

IZON Setting 05

1x **937050344** – Coffee table, ø 111 cm, black pepper/lava
 1x **937070344** – Coffee table, 50 x 130 cm, black pepper/lava

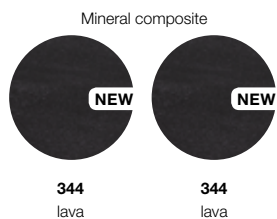

IZON Setting 06

1x **933040343** – Coffee table, 120 x 120 cm, lipari/talc
 1x **933070343** – Coffee table, 50 x 130 cm, lipari/talc

For inspiration please see DEDON Lookbook 2020, page 50

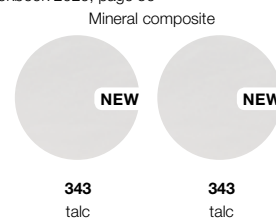



Side table ø 54,5 cm, nori/glass nori
Coffee table ø 111 cm, lipari/talc



2x Beach chair XS

Fibers



018
java



004
seagrass

BEACH CHAIR XS
Sonnenliege XS
Tumbona XS
Lettino XS
Chaise longue XS
15 kg 0,92 m²



035018018

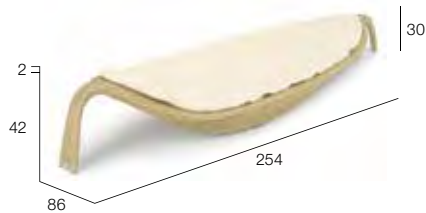

035018004

CUSHION
Kissen
Toalla
Cuscino
Matelas
80 x 210 cm



035018

99035018000

56035018000

EN Special padded towel in the design of a leaf. Padded towel only available in this design. Material: Cotton. **DE** Spezialauflage im Blatt-Design. Die Auflage ist ausschließlich in dieser Form erhältlich. Material: Baumwolle. **ES** Toalla especial con forma de hoja. La toalla sólo está disponible en este diseño. Material: algodón. **IT** Cuscino speciale a forma di foglia. Il cuscino è disponibile esclusivamente in questa forma. Materiale: cotone. **FR** Matelas sous forme d'une feuille. Modèle unique de matelas. Matière: coton.





Right module
Center module
Corner module
Coffee table 68 x 126 cm
Tray
Cushion: COOL taupe

Recommended combination

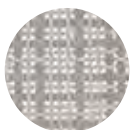

107
clay

+

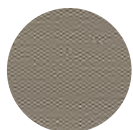

452
COOL taupe
Cat. A



661
TWIST sand
Cat. B

LOUNGE CHAIR
Sessel
Sillón bajo
Poltrona club
Fauteuil club
16 kg 0,71 m³



SEAT CUSHION + BACK CUSHION
Sitzkissen + Rückenkissen
Cojín de asiento + Cojín de respaldo
Cuscino seduta + Cuscino schienale
Coussin d'assise + Coussin de dossier
68 × 68 cm + 102 × 38 cm



079005

079005107

95079005

56079005000

CENTER MODULE
Modul mitte
Módulo centro
Modulo centrale
Module central
13 kg 0,71 m³



SEAT CUSHION + BACK CUSHION
Sitzkissen + Rückenkissen
Cojín de asiento + Cojín de respaldo
Cuscino seduta + Cuscino schienale
Coussin d'assise + Coussin de dossier
102 × 68 cm + 102 × 38 cm



079008

079008107

95079008

56079008000

LEFT MODULE
Modul links
Módulo izquierdo
Modulo sinistro
Module gauche
16 kg 0,95 m³



SEAT CUSHION + BACK CUSHION + SIDE CUSHION
Sitzkissen + Rückenkissen + Seitenkissen
Cojín de asiento + Cojín de respaldo + Cojín lateral
Cuscino seduta + Cuscino schienale + Cuscino laterale
Coussin d'assise + Coussin de dossier + Coussin latéral
102 × 68 cm + 136 × 38 cm + 39 × 31 × 6 cm

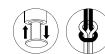

079007

079007107

95079007

56079007000

RIGHT MODULE
Modul rechts
Módulo derecho
Modulo destro
Module droit
16 kg 0,95 m³



SEAT CUSHION + BACK CUSHION + SIDE CUSHION
Sitzkissen + Rückenkissen + Seitenkissen
Cojín de asiento + Cojín de respaldo + Cojín lateral
Cuscino seduta + Cuscino schienale + Cuscino laterale
Coussin d'assise + Coussin de dossier + Coussin latéral
102 × 68 cm + 136 × 38 cm + 39 × 31 × 6 cm



079006

079006107

95079007

56079006000

CORNER MODULE
Eckmodul
Módulo esquina
Modulo d'angolo
Module d'angle
14 kg 0,71 m³



SEAT CUSHION + CORNER BACK CUSHION
Sitzkissen + Rückenkissen über Eck
Cojín de asiento + Cojín de respaldo de esquina
Cuscino seduta + Cuscino schienale angolare
Coussin d'assise + Coussin de dossier formant un angle
68 × 68 cm + 150 × 38 cm

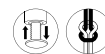

079009

079009107

95079009

56079009000

CURVED MODULE
Bogenmodul
Módulo curvo
Modulo curvo
Module incurvé
19 kg 1,4 m³



SEAT CUSHION + BACK CUSHION
Sitzkissen + Rückenkissen
Cojín de asiento + Cojín de respaldo
Cuscino seduta + Cuscino schienale
Coussin d'assise + Coussin de dossier
162 × 68 cm + 168 × 38 cm



079010

079010107

95079010

56079010000

CHAISE LONGUE
Chaise longue
Chaise longue
Chaise longue
Chaise longue
20 kg 1,2 m³



SEAT CUSHION + BACK CUSHION
Sitzkissen + Rückenkissen
Cojín de asiento + Cojín de respaldo
Cuscino seduta + Cuscino schienale
Coussin d'assise + Coussin de dossier
102 × 138 cm + 102 × 38 cm

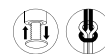

079008 + 079032

079008107 + 079032107

95079002

56079002000

DAYBED LEFT
Daybed links
Daybed izquierdo
Daybed sinistro
Daybed gauche
23 kg 1,6 m³



SEAT CUSHION + BACK CUSHION + SIDE CUSHION
Sitzkissen + Rückenkissen + Seitenkissen
Cojín de asiento + Cojín de respaldo + Cojín lateral
Cuscino seduta + Cuscino schienale + Cuscino laterale
Coussin d'assise + Coussin de dossier + Coussin latéral
102 × 136 cm + 136 × 38 cm + 39 × 31 × 6 cm



079007 + 079032

079007107 + 079032107

95079018

56079018000

DAYBED RIGHT
Daybed rechts
Daybed derecho
Daybed destro
Daybed droit
23 kg 1,6 m³



SEAT CUSHION + BACK CUSHION + SIDE CUSHION
Sitzkissen + Rückenkissen + Seitenkissen
Cojín de asiento + Cojín de respaldo + Cojín lateral
Cuscino seduta + Cuscino schienale + Cuscino laterale
Coussin d'assise + Coussin de dossier + Coussin latéral
102 × 136 cm + 136 × 38 cm + 39 × 31 × 6 cm



079006 + 079032

079006107 + 079032107

95079018

56079017000

BEACH CHAIR
Sonnenliege
Tumbona
Lettino
Chaise longue
19 kg 1,5 m³



CUSHION
Kissen
Cojín
Cuscino
Coussin
195 × 75 cm



079119

079119107

95079119

56079119000

FOOTSTOOL / COFFEE TABLE
Hocker / Kaffeetisch
Reposapiés / Mesa de centro
Pouf / Tavolino da salotto
Repose-pieds / Table de salon
102 × 102 cm
8 kg 0,32 m³



SEAT CUSHION
Sitzkissen
Cojín de asiento
Cuscino seduta
Coussin d'assise
102 × 102 cm



079031

079031107

95079031

56079031000



MONOLITE TAUPE
Monolite taupe
Monolite taupe
Monolite taupe
Monolite taupe
39 kg

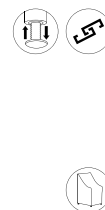

Set: 079030107

23379030308

56079030000

FOOTSTOOL / COFFEE TABLE
Hocker / Kaffeetisch
Reposapiés / Mesa de centro
Pouf / Tavolino da salotto
Repose-pieds / Table de salon
68 × 102 cm
7 kg 0,22 m³



SEAT CUSHION
Sitzkissen
Cojín de asiento
Cuscino seduta
Coussin d'assise
102 × 68 cm



079032

079032107

95079032

56079032000



MONOLITE TAUPE
Monolite taupe
Monolite taupe
Monolite taupe
Monolite taupe
19,5 kg



Set: 079033107

23379033308

56079033000

RECOMMENDED DECO CUSHIONS

Empfohlene Dekokissen
 Cojines decoración recomendados
 Cuscini decorativi consigliati
 Coussins déco recommandés

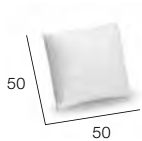

95050082

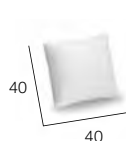

95050081

COFFEE TABLE

Kaffeetisch
 Mesa de centro
 Tavolino da salotto
 Table de salon
68 x 126 cm
 15,5 kg 0,29 m³



079035205

56079035000



COFFEE TABLE

Kaffeetisch
 Mesa de centro
 Tavolino da salotto
 Table de salon
68 x 170 cm
 19 kg 0,38 m³



079037205

56079037000



COFFEE TABLE

Kaffeetisch
 Mesa de centro
 Tavolino da salotto
 Table de salon
ø 68 cm
 8,2 kg 0,17 m³



079036205

56079036000



COFFEE TABLE

Kaffeetisch
 Mesa de centro
 Tavolino da salotto
 Table de salon
ø 102 cm
 15,3 kg 0,38 m³



079034205

56079034000



SIDE TABLE

Beistelltisch
 Mesa auxiliar
 Tavolino d'appoggio
 Table d'appoint
35 x 50 cm
 5 kg 0,1 m³

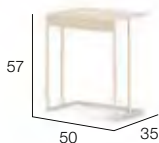

079039098

56079039000



Tabletop ceramic



308 taupe

Coffee table 079030, coffee table 079033

Tabletop teak



205 teak

Coffee table 079035, coffee table 079037
 Coffee table 079036, coffee table 079034

+

Powder coating



304 lipari

TRAY
Tablett
Bandeja
Vassoio
Plateau



079099201

EN The **LOU collection** includes two different types of **coffee tables**. One features a base woven with DEDON Fiber and a tabletop made of Monolite Ipergres®, a frost-proof ceramic material that is non-absorbing and highly resistant to indirect tensile stress, impacts, scratches and abrasions. The other table comes in two different shapes and four sizes, the round ones overlapping the square ones. These coffee tables feature a premium teak tabletop on a base of powder coated stainless steel.

The **LOU side table** consists of powder-coated stainless steel.

The **LOU tray** consists of cross-laminated teak veneer. To protect it from moisture, we recommend keeping it indoors when not in use.

DE Für die **LOU Kollektion** stehen zwei verschiedene **Kaffeetische** zur Auswahl. Eine Version besteht aus einer mit DEDON-Faser geflochtenen Basis und einer Tischplatte aus Monolite Ipergres®, einem frostsicheren, wasserabweisenden Keramikmaterial mit ausgezeichneter Kratz- und Abriebfestigkeit. Der andere Tisch ist in zwei unterschiedlichen Formen und vier Größen erhältlich, wobei die runden die eckigen überlappen. Diese Kaffeetische bestehen aus einer hochwertigen Teakholz-Tischplatte und einem Gestell aus pulverbeschichtetem Edelstahl.

Der **LOU Beistelltisch** ist aus pulverbeschichtetem Edelstahl gefertigt. Das **LOU Tablett** besteht aus Teak-Schichtholz. Um es vor Feuchtigkeit zu schützen, sollte es in Innenräumen aufbewahrt werden.

ES La **colección LOU** dispone de dos versiones de **mesas de centro** diferentes. Una está realizada a base de tejido con fibra DEDON con un tablero hecho de Monolite Ipergres® es un material cerámico resistente a las heladas y hermético al agua, con una resistencia excelente contra los arañazos, la abrasión así como a la presión indirecta. La otra mesa se presenta en dos formas diferentes y cuatro tamaños en total, las mesas redondas se pueden colocar solapando las mesas rectangulares. Estas mesas de centro cuentan con un sobre de teca de alta calidad sobre una base de acero con acabado de pintura en polvo.

La **mesa auxiliar LOU** está hecha de acero inoxidable con acabado de pintura en polvo.

La **bandeja LOU** se compone de chapa de madera de teca laminada. Para protegerla contra la humedad, le recomendamos que, cuando no se utilize, la guarde en un espacio cerrado.

IT La **collezione LOU** include due diversi tipi di **tavolini da salotto**. Uno dispone di una base intrecciata con fibra DEDON e di un piano in Monolite Ipergres®, un materiale ceramico resistente al gelo, non assorbente e altamente resistente ai graffi e alle abrasioni. L'altro tavolo è disponibile in due diverse forme e quattro misure, in modo che quelli rotondi possano sovrapporsi a quelli quadrati. Questi tavolini da salotto presentano un piano in teak di prima qualità su una base in acciaio inox verniciata a polvere.

Il **tavolino da salotto LOU** è in acciaio inox. Verniciato a polvere.

Il **vassoio LOU** presenta uno strato di rivestimento in teak. Per proteggerlo dall'umidità dovrebbe essere conservato in un luogo interno.

FR La **collection LOU** comprend deux types de **tables de salon**. L'une possède une base tressée avec la fibre DEDON et un plateau en Monolite Ipergres®, un matériau céramique résistant au gel, imperméable et hautement résistant aux contraintes de traction indirectes, aux impacts, aux rayures et à l'abrasion. La seconde table est disponible en deux formes différentes et quatre tailles, les tables rondes recouvrant les tables carrées. Ces tables de salon comprennent un plateau de table en teck de grande qualité sur une base d'acier inoxydable laqué. La **table d'appoint LOU** est en acier inoxydable thermolaqué. Le **plateau LOU** est en teck contreplaqué. Afin de le protéger de l'humidité, il est recommandé de le conserver à l'intérieur, lorsqu'il n'est pas utilisé.

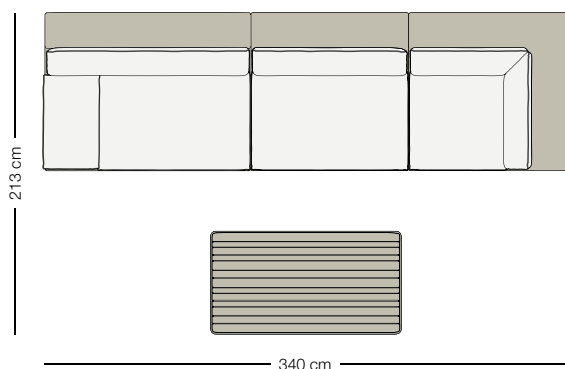

LOU Setting 01

- 1x **079006** – Right module, seat cushion + back cushion + side cushion
- 1x **079008** – Center module, seat cushion + back cushion
- 1x **079009** – Corner module, seat cushion + corner back cushion
- 1x **079035** – Coffee table 68 x 126 cm, teak top

Recommended deco cushions:

- 2x **95050081** – 40 x 40 cm
- 1x **95050082** – 50 x 50 cm

For inspiration please see page 60 and DEDON Lookbook 2020, page 119

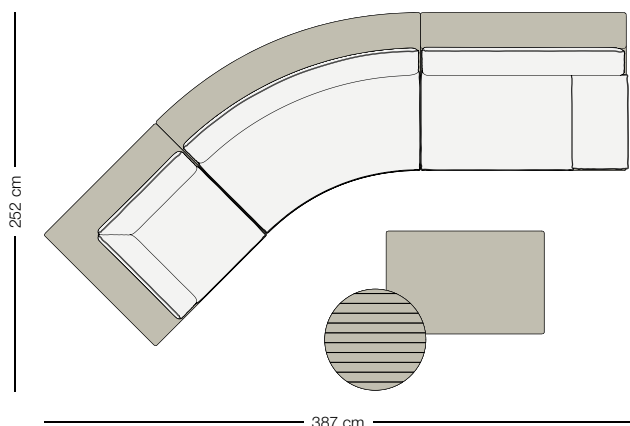

LOU Setting 02

- 1x **079009** – Corner module, seat cushion + corner back cushion
- 1x **079010** – Curved module, seat cushion + back cushion
- 1x **079007** – Left module, seat cushion + back cushion + side cushion
- 1x **079033** – Coffee table 68 x 102 cm, Monolite lpergres® taupe top
- 1x **079036** – Coffee table ø 68 cm, teak top

Recommended deco cushions:

- 2x **95050081** – 40 x 40 cm
- 1x **95050082** – 50 x 50 cm

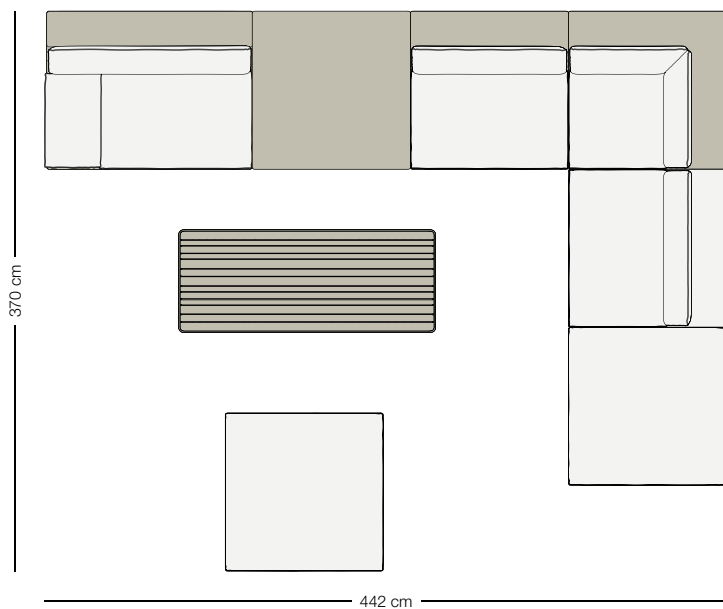

LOU Setting 03

- 1x **079006** – Right module, seat cushion + back cushion + side cushion
- 1x **079030** – Coffee table 102 x 102 cm, Monolite lpergres® taupe top
- 2x **079008** – Center module, seat cushion + back cushion
- 1x **079009** – Corner module, seat cushion + corner back cushion
- 2x **079031** – Footstool 102 x 102 cm, seat cushion
- 1x **079037** – Coffee table 68 x 170 cm, teak top

Recommended deco cushions:

- 3x **95050081** – 40 x 40 cm
- 2x **95050082** – 50 x 50 cm



Corner module, taupe duet
 Center module XXL, taupe duet
 Left module, taupe duet
 Footstool, taupe duet
 Cushion: COOL marengo
 PORCINI side tables

Recommended combinations



+

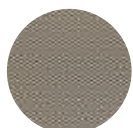

452
 COOL taupe
 Cat. A



660
 TWIST beige
 Cat. B



366
 taupe duet

+



455
 COOL marengo
 Cat. A



661
 TWIST sand
 Cat. B



066
 bleach

+

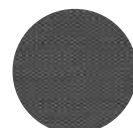

454
 COOL dark gray
 Cat. A



660
 TWIST beige
 Cat. B

LOUNGE CHAIR

Sessel
Sillón bajo
Poltrona club
Fauteuil club
21 kg 0,84 m²



029008018



029008366

SEAT CUSHION + BACK CUSHION
Sitzkissen + Rückenkissen
Cojín de asiento + Cojín de respaldo
Cuscino seduta + Cuscino schienale
Coussin d'assise + Coussin de dossier
90 x 75 cm + 90 x 34 cm



95029008

56029008000

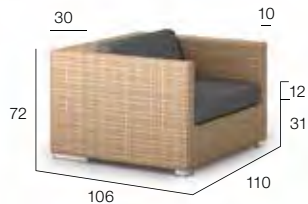

029008066

PLUSH SEAT CUSHION + BACK CUSHION
Plush Sitzkissen + Rückenkissen
Plush cojín de asiento + Cojín de respaldo
Plush cuscino seduta + Cuscino schienale
Plush coussin d'assise + Coussin de dossier
90 x 75 cm + 90 x 34 cm

95029208

LEFT MODULE

Modul links
Módulo izquierdo
Modulo sinistro
Module gauche
19 kg 0,92 m²



029005018



029005366

SEAT CUSHION + BACK CUSHION
Sitzkissen + Rückenkissen
Cojín de asiento + Cojín de respaldo
Cuscino seduta + Cuscino schienale
Coussin d'assise + Coussin de dossier
111 x 75 cm + 111 x 34 cm

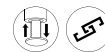

95029005

56029005000



029005066

PLUSH SEAT CUSHION + BACK CUSHION
Plush Sitzkissen + Rückenkissen
Plush cojín de asiento + Cojín de respaldo
Plush cuscino seduta + Cuscino schienale
Plush coussin d'assise + Coussin de dossier
111 x 75 cm + 111 x 34 cm

95029205

RIGHT MODULE

Modul rechts
Módulo derecho
Modulo destro
Module droit
19 kg 0,92 m²



029003018



029003366

SEAT CUSHION + BACK CUSHION
Sitzkissen + Rückenkissen
Cojín de asiento + Cojín de respaldo
Cuscino seduta + Cuscino schienale
Coussin d'assise + Coussin de dossier
111 x 75 cm + 111 x 34 cm

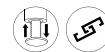

95029003

56029003000

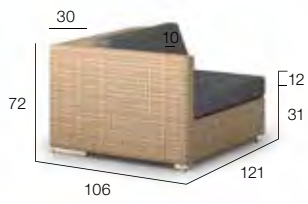

029003066

PLUSH SEAT CUSHION + BACK CUSHION
Plush Sitzkissen + Rückenkissen
Plush cojín de asiento + Cojín de respaldo
Plush cuscino seduta + Cuscino schienale
Plush coussin d'assise + Coussin de dossier
111 x 75 cm + 111 x 34 cm

95029203

RECOMMENDED DECO CUSHIONS

Empfohlene Dekokissen
Cojines decoración recomendados
Cuscini decorativi consigliati
Coussins déco recommandés

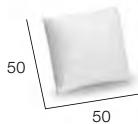

95050082

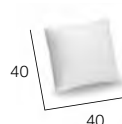

95050081

CENTER MODULE

Modul mitte
Módulo centro
Modulo centrale
Module central
11,5 kg 0,5 m³



SEAT CUSHION + BACK CUSHION *
Sitzkissen + Rückenkissen
Cojín de asiento + Cojín de respaldo
Cuscino seduta + Cuscino schienale
Coussin d'assise + Coussin de dossier
66 x 75 cm + 66 x 34 cm



029001

029001018

029001366

95029001

56029001000



PLUSH SEAT CUSHION + BACK CUSHION *
Plush Sitzkissen + Rückenkissen
Plush cojín de asiento + Cojín de respaldo
Plush cuscino seduta + Cuscino schienale
Plush coussin d'assise + Coussin de dossier
66 x 75 cm + 66 x 34 cm

029001066

95029201

CENTER MODULE XXL

Modul mitte XXL
Módulo centro XXL
Modulo centrale XXL
Module central XXL
16 kg 0,84 m³



SEAT CUSHION + BACK CUSHION *
Sitzkissen + Rückenkissen
Cojín de asiento + Cojín de respaldo
Cuscino seduta + Cuscino schienale
Coussin d'assise + Coussin de dossier
110 x 75 cm + 110 x 34 cm*



029002

029002018

029002366

95029002

56029002000



PLUSH SEAT CUSHION + BACK CUSHION *
Plush Sitzkissen + Rückenkissen
Plush cojín de asiento + Cojín de respaldo
Plush cuscino seduta + Cuscino schienale
Plush coussin d'assise + Coussin de dossier
110 x 75 cm + 110 x 34 cm

029002066

95029202

CURVED MODULE

Bogenmodul
Módulo curvo
Modulo curvo
Module incurvé
16 kg 1,16 m³



SEAT CUSHION + BACK CUSHION
Sitzkissen + Rückenkissen
Cojín de asiento + Cojín de respaldo
Cuscino seduta + Cuscino schienale
Coussin d'assise + Coussin de dossier
127 x 83 cm + 127 x 34 cm



029006

029006018

029006366

95029006

56029006000



PLUSH SEAT CUSHION + BACK CUSHION
Plush Sitzkissen + Rückenkissen
Plush cojín de asiento + Cojín de respaldo
Plush cuscino seduta + Cuscino schienale
Plush coussin d'assise + Coussin de dossier
127 x 83 cm + 127 x 34 cm

029006066

95029206

EN The DEDON Fiber taupe duet is made with a special injection-molding technique that unites two color tones in a vibrant way. The fibers bleach and java are natural color tones whose subtle variations give them a lively and charming look while ensuring that every piece of furniture woven with them is unique.

DE Unsere zweifarbige DEDON-Faser in taupe duet wird in einem speziellen Spritzgussverfahren hergestellt, durch das eine lebhaftere Verbindung von zwei Farbtönen entsteht. Bleach und java sind zwei natürliche Farbtöne, deren subtiles Farbenspiel innerhalb der Faserstruktur dem Möbel einen lebendigen Charme einhaucht. Dies ist der Grund dafür, dass jedes Möbelstück einzigartig ist und keines dem anderen gleicht.

ES El tono taupe duet de la fibra DEDON está elaborado a partir de una técnica especial de moldeado por inyección, lo cual permite combinar dos colores obteniendo un resultado vibrante. Las fibras bleach y java son tonalidades naturales que presentan sutiles variaciones que aportan un aspecto vivo y alegre a la vez que hacen de cada pieza de mobiliario tejido un producto realmente único.

IT La Fibra DEDON taupe duet è realizzata con una speciale tecnica di stampaggio a iniezione che dà vita ad una vibrante combinazione di due tonalità di colore. Le fibre bleach e java sono tonalità cromatiche naturali, le cui sottili variazioni conferiscono un aspetto vivace e affascinante, garantendo che ogni pezzo intessuto con queste fibre sia un pezzo unico.

FR Le duo de fibre DEDON taupe duet est fabriqué avec une technique spéciale de moulage par injection qui réunit deux coloris de manière dynamique. Les fibres bleach et java sont des coloris naturels dont les variations subtiles leur fournissent un aspect plein d'entrain et élégant tout en assurant que chaque meuble tissé avec elles est unique en son genre.

CORNER MODULE

Eckmodul
Módulo esquina
Modulo d'angolo
Module d'angle
18 kg 0,81 m³



029007018

029007366

SEAT CUSHION + CORNER BACK CUSHION *
Sitzkissen + Rückenissen über Eck
Cojin de asiento + Cojin de respaldo de esquina
Cuscino seduta + Cuscino schienale angolare
Coussin d'assise + Coussin de dossier formant un angle
75 x 75 cm + 150 x 34 cm

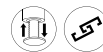

029007

95029007

56029007000



029007066

PLUSH SEAT CUSHION + CORNER BACK CUSHION *
Plush Sitzkissen + Rückenissen über Eck
Plush cojin de asiento + Cojin de respaldo de esquina
Plush cuscino seduta + Cuscino schienale angolare
Plush coussin d'assise + Coussin de dossier formant un angle
75 x 75 cm + 150 x 34 cm

95029207



SEAT CUSHION + ONE-SIDED BACK CUSHION *
Sitzkissen + 1-seitiges Rückenissen
Cojin de asiento + Cojin de respaldo de un lado
Cuscino seduta + Cuscino schienale su un solo lato
Coussin d'assise + Coussin pour un côté du dossier
75 x 75 cm + 75 x 34 cm

95029017



PLUSH SEAT CUSHION + ONE-SIDED BACK CUSHION *
Plush Sitzkissen + 1-seitiges Rückenissen
Plush cojin de asiento + Cojin de respaldo de un lado
Plush cuscino seduta + Cuscino schienale su un solo lato
Plush coussin d'assise + Coussin pour un côté du dossier
75 x 75 cm + 75 x 34 cm

95029217

DAYBED

Daybed
Daybed
Daybed
Daybed
26 kg 1,71 m³



029002018 + 029037018

029002366 + 029037366

CUSHION + BACK CUSHION **
Kissen + Rückenissen
Cojin + Cojin de respaldo
Cuscino + Cuscino schienale
Coussin + Coussin de dossier
110 x 186 cm + 110 x 35 cm

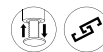

029002 + 029037

95029018

56029018000

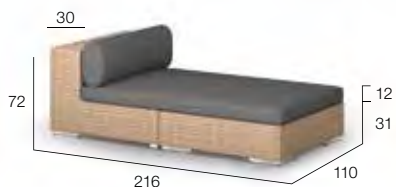

029002066 + 029037066

PLUSH SEAT CUSHION + BACK CUSHION **
Plush Sitzkissen + Rückenissen
Plush cojin de asiento + Cojin de respaldo
Plush cuscino seduta + Cuscino schienale
Plush coussin d'assise + Coussin de dossier
110 x 186 cm + 110 x 35 cm

95029218

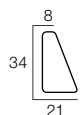

* EN Back cushion DE Rückenissen ES Cojin de respaldo IT Cuscino schienale FR Coussin de dossier



** EN Back cushion DE Rückenissen ES Cojin de respaldo IT Cuscino schienale FR Coussin de dossier

BEACH CHAIR *
 Sonnenliege
 Tumbona
 Lettino
 Chaise longue
 22,5 kg 0,4 m³



CUSHION
 Kissen
 Cojín
 Cuscino
 Coussin
 65 x 190 cm



029119

029119018

029119366

95029019

56029019000

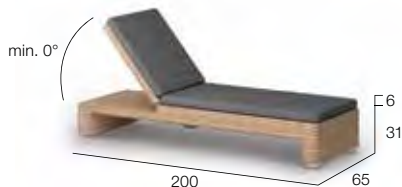

PLUSH CUSHION
 Plush Kissen
 Plush cojín
 Plush cuscino
 Plush coussin
 65 x 190 cm

029119066

95029219

FOOTSTOOL / COFFEE TABLE
 Hocker / Kaffeetisch
 Reposapiés / Mesa de centro
 Pouf / Tavolino da salotto
 Repose-pieds / Table de salon
 110 x 110 cm
 10,5 kg 0,38 m³



SEAT CUSHION
 Sitzkissen
 Cojín de asiento
 Cuscino seduta
 Coussin d'assise
 110 x 110 cm

PLUSH SEAT CUSHION
 Plush Sitzkissen
 Plush cojín de asiento
 Plush cuscino seduta
 Plush coussin d'assise
 110 x 110 cm

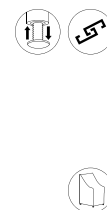

029037

029037018

029037366

029037066

95029037

95029237

56029030000



CLEAR GLASS TOP
 Klarglasplatte
 Sobre de cristal transparente
 Piano in vetro trasparente
 Plaque en verre clair
 17,5 kg

Set: 029038018

Set: 029038366

Set: 029038066

22229037000

56029037000

FOOTSTOOL / COFFEE TABLE
 Hocker / Kaffeetisch
 Reposapiés / Mesa de centro
 Pouf / Tavolino da salotto
 Repose-pieds / Table de salon
 65 x 110 cm
 7 kg 0,22 m³



SEAT CUSHION
 Sitzkissen
 Cojín de asiento
 Cuscino seduta
 Coussin d'assise
 65 x 110 cm

PLUSH SEAT CUSHION
 Plush Sitzkissen
 Plush cojín de asiento
 Plush cuscino seduta
 Plush coussin d'assise
 65 x 110 cm

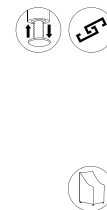

029035

029035018

029035366

029035066

95029035

95029235

56029031000



CLEAR GLASS TOP
 Klarglasplatte
 Sobre de cristal transparente
 Piano in vetro trasparente
 Plaque en verre clair
 10,5 kg

Set: 029036018

Set: 029036366

Set: 029036066

22229035000

56029035000

Tabletop glass



000 clear glass

EN This item is also available with hook-catching mechanism upon request.

DE Dieser Artikel ist auf Anfrage auch mit Stufenverstellung erhältlich.

ES Bajo pedido este artículo también está disponible con un mecanismo de ajuste escalonado.

IT Questo articolo è disponibile su richiesta anche con meccanismo di regolazione reclinabile.

FR Cet article est disponible, sur demande, avec un mécanisme de réglage du niveau d'inclinaison.

CUSHION OPTIONS

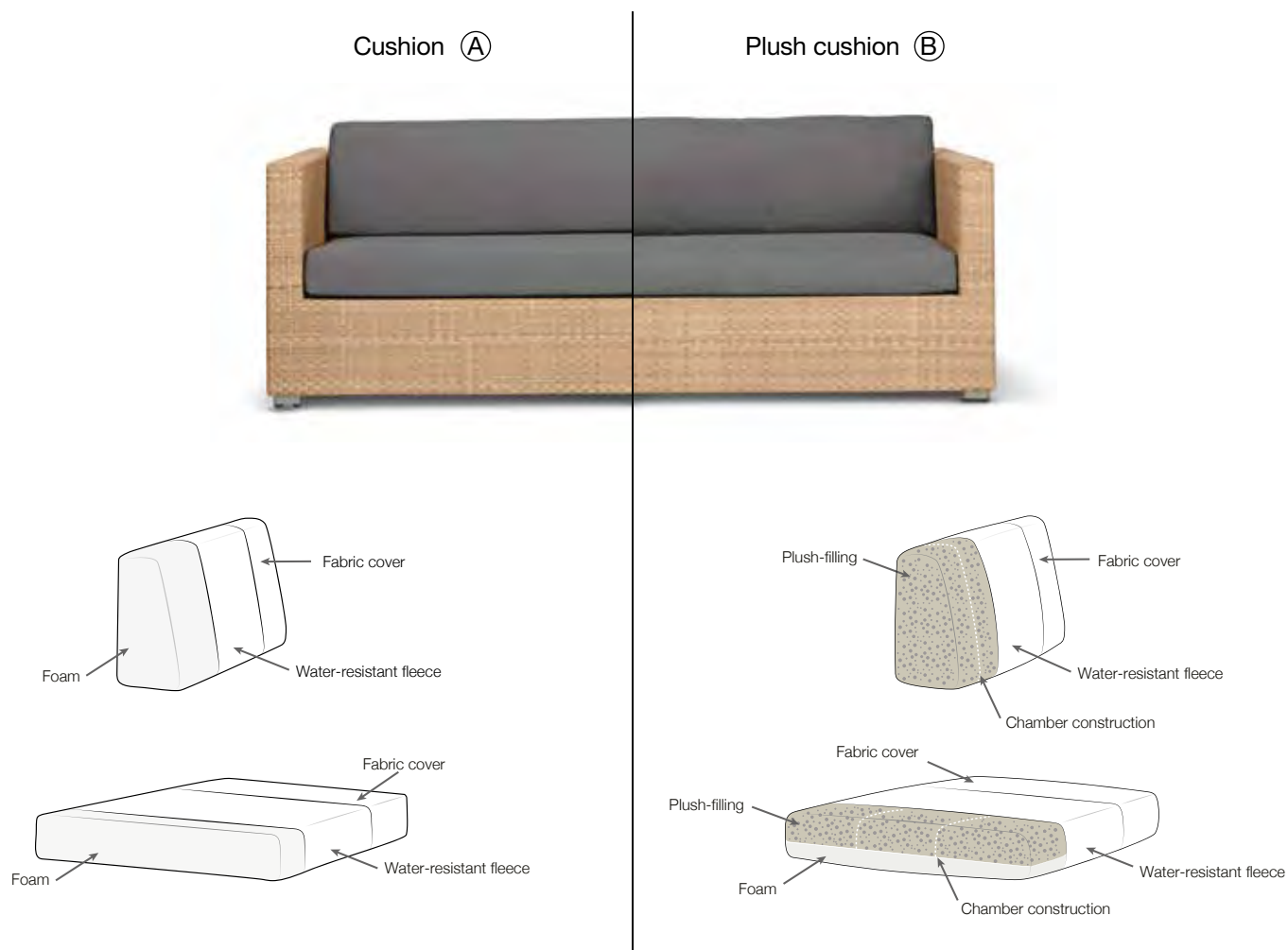

EN The LOUNGE modules come with two cushion options. Cushion (A) with its clean lines provides sturdy sitting comfort, while the plush version (B) offers a more cozy experience with softer lines. Shake the plush cushions occasionally to ensure that they retain maximum comfort.

DE LOUNGE Module bieten zwei Kissenoptionen: Das Kissen (A) zeichnet sich durch einen stabilen Sitzkomfort und eine geradlinige Anmutung aus, während die Plush-Kissenversion (B) ein komfortables Sitzgefühl vermittelt und sich in weicheren Formen darstellt. Für maximalen Komfort schütteln Sie bitte die Plush Kissen zwischendurch auf.

ES Los módulos LOUNGE ofrecen dos tipos de cojines: el cojín (A) se caracteriza por su confort y estabilidad y por su aspecto rectilíneo, mientras que la versión "Plush" del cojín (B) proporciona una sensación de comodidad al sentarse, y muestra formas más suaves. Agite los cojines "Plush" de vez en cuando a fin de que conserven el máximo confort.

IT I moduli LOUNGE offrono due opzioni di cuscini: il cuscino (A) è caratterizzato da una seduta stabile e confortevole e da un aspetto rettilineo, mentre i cuscini Plush della versione (B) trasmettono una sensazione di comodità della seduta e presentano forme più morbide. Scuotere di tanto in tanto i cuscini "Plush" per garantire sempre il massimo confort.

FR Avec les modules LOUNGE, deux types de coussins sont en option : plus de stabilité et un design plus graphique pour la version (A), davantage de confort et des formes plus douces pour les coussins en peluche de la version (B). Secouez de temps en temps les coussins „Plush“ pour vous assurer qu'ils conservent tout leur confort.

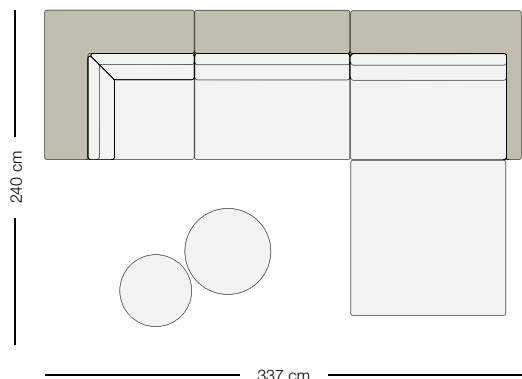

LOUNGE Setting 01

- 1x **029007** – Corner module, seat cushion + corner back cushion
- 1x **029002** – Center module XXL, seat cushion + back cushion
- 1x **029005** – Left module, seat cushion + back cushion
- 1x **029037** – Footstool 110 x 110 cm, seat cushion

- 1x **087034301** – PORCINI side table, black
- 1x **087036301** – PORCINI side table, black

Recommended deco cushions:

- 4x **95050081** – 40 x 40 cm
- 3x **95050082** – 50 x 50 cm

For inspiration please see page 66

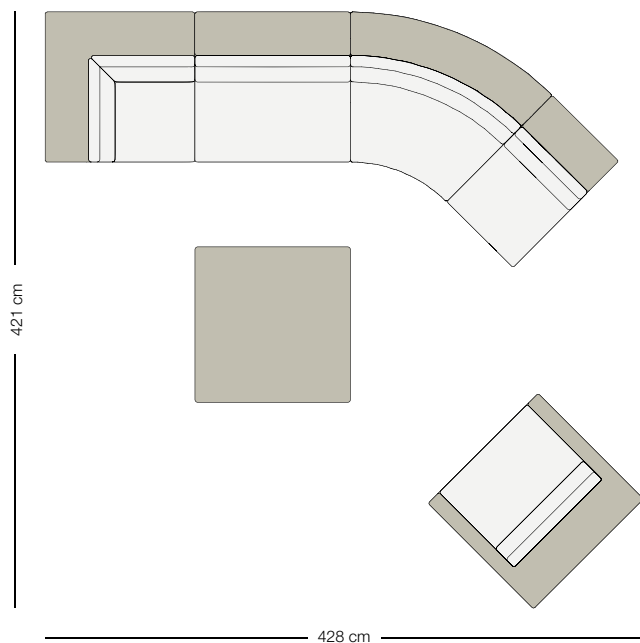

LOUNGE Setting 02

- 1x **029008** – Lounge chair, seat cushion + back cushion
- 1x **029001** – Center module, seat cushion + back cushion
- 1x **029006** – Curved module, seat cushion + back cushion
- 1x **029002** – Center module XXL, seat cushion + back cushion
- 1x **029007** – Corner module, seat cushion + corner back cushion
- 1x **029038** – Coffee table 110 x 110 cm, clear glass top

Recommended deco cushions:

- 2x **95050081** – 40 x 40 cm
- 1x **95050082** – 50 x 50 cm

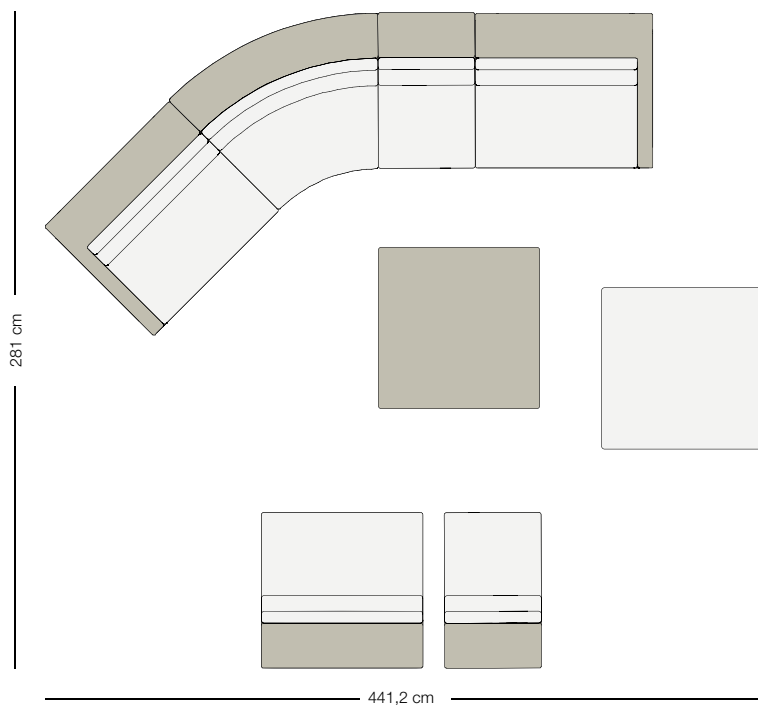

LOUNGE Setting 03

- 1x **029003** – Right module, seat cushion + back cushion
- 1x **029006** – Curved module, seat cushion + back cushion
- 2x **029001** – Center module, seat cushion + back cushion
- 1x **029005** – Left module, seat cushion + back cushion
- 1x **029038** – Coffee table 110 x 110 cm, clear glass top
- 1x **029037** – Footstool 110 x 110 cm, seat cushion
- 1x **029002** – Center module XXL, seat cushion + back cushion

Recommended deco cushions:

- 3x **95050081** – 40 x 40 cm
- 2x **95050082** – 50 x 50 cm

For inspiration please see DEDON Lookbook 2020, page 122













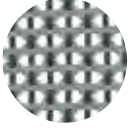

LOUNGE corner module, taupe duet
Plush cushion: COOL taupe

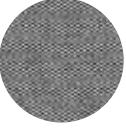

3-seater, high backrest, chestnut
 Cushion: TWIST terracotta
 3 additional back cushions
 MBRACE side tables

Recommended combinations

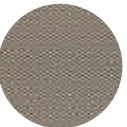
Fiber	Powder coating	Recommended fabrics	
			
151 chestnut	084 terracotta	462 COOL sage Cat. A	663 TWIST terracotta Cat. B
Fiber	Powder coating	Recommended fabrics	
			
141 baltic	133 nori	458 COOL ash Cat. A	664 TWIST dark turquoise Cat. B

Fiber	Powder coating	Recommended fabrics	
			
115 pepper	304 lipari	452 COOL taupe Cat. A	661 TWIST sand Cat. B

3-SEATER
3er-Sofa
Sofá 3 plazas
Divano 3 posti
Canapé 3 places
23,6 kg 1,45 m³



109015

109015115

109015151

CUSHION SET
Kissenset
Set de cojines
Set di cuscini
Set de coussins

ADDITIONAL BACK CUSHION
Zusätzliches Rückenkissen
Cojín de respaldo adicional
Cuscino schienale supplementare
Coussin de dossier supplémentaire
62 x 32 x 16 cm



95109015

3x 95109090

56109015000

DRY+ CUSHION SET
Dry+ Kissenset
Dry+ Set de cojines
Dry+ Set di cuscini
Dry+ Set de coussins

DRY+ ADDITIONAL BACK CUSHION
Dry+ zusätzliches Rückenkissen
Dry+ cojín de respaldo adicional
Dry+ cuscino schienale supplementare
Dry+ coussin de dossier supplémentaire
62 x 32 x 16 cm



109015141

95109215

3x 95109290

3-SEATER, HIGH BACKREST
3-Sitzer, hohe Rückenlehne
Sofá 3 plazas, respaldo alto
Divano 3 posti, schienale alto
Canapé 3 places, haut dossier
28 kg 2,12 m³



109016

109016115

109016151

CUSHION SET
Kissenset
Set de cojines
Set di cuscini
Set de coussins

ADDITIONAL BACK CUSHION
Zusätzliches Rückenkissen
Cojín de respaldo adicional
Cuscino schienale supplementare
Coussin de dossier supplémentaire
62 x 32 x 16 cm



95109015

3x 95109090

56109016000

DRY+ CUSHION SET
Dry+ Kissenset
Dry+ Set de cojines
Dry+ Set di cuscini
Dry+ Set de coussins

DRY+ ADDITIONAL BACK CUSHION
Dry+ zusätzliches Rückenkissen
Dry+ cojín de respaldo adicional
Dry+ cuscino schienale supplementare
Dry+ coussin de dossier supplémentaire
62 x 32 x 16 cm



109016141

95109215

3x 95109290

LEFT MODULE
Modul links
Módulo izquierdo
Modulo sinistro
Module gauche
22,7 kg 1,36 m³



109005

109005115

109005151

CUSHION SET
Kissenset
Set de cojines
Set di cuscini
Set de coussins

ADDITIONAL BACK CUSHION
Zusätzliches Rückenkissen
Cojín de respaldo adicional
Cuscino schienale supplementare
Coussin de dossier supplémentaire
62 x 32 x 16 cm



95109015

3x 95109090

56109005000

DRY+ CUSHION SET
Dry+ Kissenset
Dry+ Set de cojines
Dry+ Set di cuscini
Dry+ Set de coussins

DRY+ ADDITIONAL BACK CUSHION
Dry+ zusätzliches Rückenkissen
Dry+ cojín de respaldo adicional
Dry+ cuscino schienale supplementare
Dry+ coussin de dossier supplémentaire
62 x 32 x 16 cm



109005141

95109215

3x 95109290

RECOMMENDED DECO CUSHIONS
Empfohlene Dekokissen
Cojines decoración recomendados
Cuscini decorativi consigliati
Coussins déco recommandés

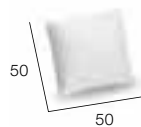

95050082

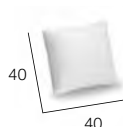

95050081

RIGHT MODULE

Modul rechts
Módulo derecho
Modulo destro
Module droit
22,7 kg 1,36 m³



CUSHION SET
Kissenset
Set de cojines
Set di cuscini
Set de coussins

ADDITIONAL BACK CUSHION
Zusätzliches Rückenkissen
Cojin de respaldo adicional
Cuscino schienale supplementare
Coussin de dossier supplémentaire
62 x 32 x 16 cm



109003

109003115

109003151

95109015

3x 95109090

56109003000



DRY+ CUSHION SET
Dry+ Kissenset
Dry+ Set de cojines
Dry+ Set di cuscini
Dry+ Set de coussins

DRY+ ADDITIONAL BACK CUSHION
Dry+ zusätzliches Rückenkissen
Dry+ cojin de respaldo adicional
Dry+ cuscino schienale supplementare
Dry+ coussin de dossier supplémentaire
62 x 32 x 16 cm



109003141

95109215

3x 95109290

LEFT CORNER MODULE

Eckmodul links
Módulo esquina izquierdo
Modulo angolare sinistro
Module d'angle gauche
23 kg 1,38 m³



CUSHION SET
Kissenset
Set de cojines
Set di cuscini
Set de coussins

ADDITIONAL BACK CUSHION
Zusätzliches Rückenkissen
Cojin de respaldo adicional
Cuscino schienale supplementare
Coussin de dossier supplémentaire
62 x 32 x 16 cm



109006

109006115

109006151

95109004

3x 95109090

56109006000



DRY+ CUSHION SET
Dry+ Kissenset
Dry+ Set de cojines
Dry+ Set di cuscini
Dry+ Set de coussins

DRY+ ADDITIONAL BACK CUSHION
Dry+ zusätzliches Rückenkissen
Dry+ cojin de respaldo adicional
Dry+ cuscino schienale supplementare
Dry+ coussin de dossier supplémentaire
62 x 32 x 16 cm



109006141

95109204

3x 95109290

RIGHT CORNER MODULE

Eckmodul rechts
Módulo esquina derecho
Modulo angolare destro
Module d'angle droit
23 kg 1,38 m³



CUSHION SET
Kissenset
Set de cojines
Set di cuscini
Set de coussins

ADDITIONAL BACK CUSHION
Zusätzliches Rückenkissen
Cojin de respaldo adicional
Cuscino schienale supplementare
Coussin de dossier supplémentaire
62 x 32 x 16 cm



109004

109004115

109004151

95109004

3x 95109090

56109004000



DRY+ CUSHION SET
Dry+ Kissenset
Dry+ Set de cojines
Dry+ Set di cuscini
Dry+ Set de coussins

DRY+ ADDITIONAL BACK CUSHION
Dry+ zusätzliches Rückenkissen
Dry+ cojin de respaldo adicional
Dry+ cuscino schienale supplementare
Dry+ coussin de dossier supplémentaire
62 x 32 x 16 cm



109004141

95109204

3x 95109290

CENTER MODULE

Modul mitte
Módulo centro
Modulo centrale
Module central
21,8 kg 1,26m³



109001115



109001151

CUSHION SET
Kissenset
Set de cojines
Set di cuscini
Set de coussins

ADDITIONAL BACK CUSHION
Zusätzliches Rückenkissen
Cojin de respaldo adicional
Cuscino schienale supplementare
Coussin de dossier supplémentaire
62 x 32 x 16 cm

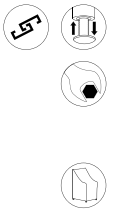

109001

95109015

3x 95109090

56109001000



109001141

DRY+ CUSHION SET
Dry+ Kissenset
Dry+ Set de cojines
Dry+ Set di cuscini
Dry+ Set de coussins

DRY+ ADDITIONAL BACK CUSHION
Dry+ zusätzliches Rückenkissen
Dry+ cojin de respaldo adicional
Dry+ cuscino schienale supplementare
Dry+ coussin de dossier supplémentaire
62 x 32 x 16 cm



DAYBED LEFT

Daybed links
Daybed izquierdo
Daybed sinistro
Daybed gauche
18,2 kg 1,38 m³



109017115



109017151

CUSHION SET
Kissenset
Set de cojines
Set di cuscini
Set de coussins

ADDITIONAL BACK CUSHION
Zusätzliches Rückenkissen
Cojin de respaldo adicional
Cuscino schienale supplementare
Coussin de dossier supplémentaire
62 x 32 x 16 cm

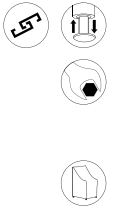

109017

95109017

95109090

56109017000



109017141

DRY+ CUSHION SET
Dry+ Kissenset
Dry+ Set de cojines
Dry+ Set di cuscini
Dry+ Set de coussins

DRY+ ADDITIONAL BACK CUSHION
Dry+ zusätzliches Rückenkissen
Dry+ cojin de respaldo adicional
Dry+ cuscino schienale supplementare
Dry+ coussin de dossier supplémentaire
62 x 32 x 16 cm



DAYBED RIGHT

Daybed rechts
Daybed derecho
Daybed destro
Daybed droit
18,2 kg 1,38 m³



109018115



109018151

CUSHION SET
Kissenset
Set de cojines
Set di cuscini
Set de coussins

ADDITIONAL BACK CUSHION
Zusätzliches Rückenkissen
Cojin de respaldo adicional
Cuscino schienale supplementare
Coussin de dossier supplémentaire
62 x 32 x 16 cm

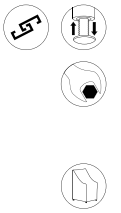

109018

95109017

95109090

56109018000



109018141

DRY+ CUSHION SET
Dry+ Kissenset
Dry+ Set de cojines
Dry+ Set di cuscini
Dry+ Set de coussins

DRY+ ADDITIONAL BACK CUSHION
Dry+ zusätzliches Rückenkissen
Dry+ cojin de respaldo adicional
Dry+ cuscino schienale supplementare
Dry+ coussin de dossier supplémentaire
62 x 32 x 16 cm



95109217

95109290

56109018000

FOOTSTOOL
 Hocker
 Reposapiés
 Pouf
 Repose-pieds
 13,7 kg 0,35 m³



109035115



109035151



109035141

SEAT CUSHION
 Sitzkissen
 Cojín de asiento
 Cuscino seduta
 Coussin d'assise



95109035

56109035000

DRY+ SEAT CUSHION
 Dry+ Sitzkissen
 Dry+ Cojín de asiento
 Dry+ Cuscino seduta
 Dry+ Coussin d'assise



95109235

EN MBRQ furniture consists of DEDON Fiber woven over a powder-coated aluminum frame. MBRQ employs the same open, vibrant triaxial weave pattern used by its cousin, MBRACE. Clean with a soft cloth and warm water.

DE Die Möbel der MBRQ-Kollektion bestehen aus DEDON-Faser, die auf einem pulverbeschichteten Aluminiumrahmen geflochten ist. Für MBRQ verwenden wir dasselbe offene und lebendige, dreiaxige Webmuster wie für unsere MBRACE-Serie. Einfach mit einem weichen Tuch und warmem Wasser zu reinigen.

ES Los muebles de MBRQ están fabricados con fibra trenzada DEDON sobre una estructura de aluminio recubierto en polvo. MBRQ emplea el mismo y vibrante dibujo de trenzado triaxial que su primo, MBRACE. Limpiar con un paño suave y agua tibia.

IT I mobili MBRQ sono realizzati in Fibra DEDON intrecciata su un telaio in alluminio verniciato a polvere. MBRQ utilizza lo stesso vibrante motivo a intreccio triassiale aperto che troviamo nel cugino MBRACE. Pulire con un panno morbido e acqua calda.

FR Les meubles MBRQ de DEDON sont fabriqués avec un cadre en aluminium thermolaqué. MBRQ utilise le même tissage triaxial ouvert et dynamique que son cousin MBRACE. Nettoyer avec un chiffon doux et de l'eau chaude.

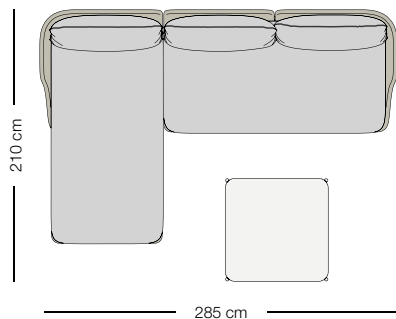

MBARQ Setting 01

- 1x **109018** – Daybed right, Dry+ cushion set
- 1x **109005** – Left module, Dry+ cushion set
- 4x **95109290** – Dry+ additional back cushions

1x **937030342** – IZON coffee table, 80 x 80 cm, black pepper/pierre blue

Recommended deco cushions:

- 2x **95050081** – 40 x 40 cm
- 1x **95050082** – 50 x 50 cm

For inspiration please see DEDON Lookbook 2020, pages 36/37 and 40/41

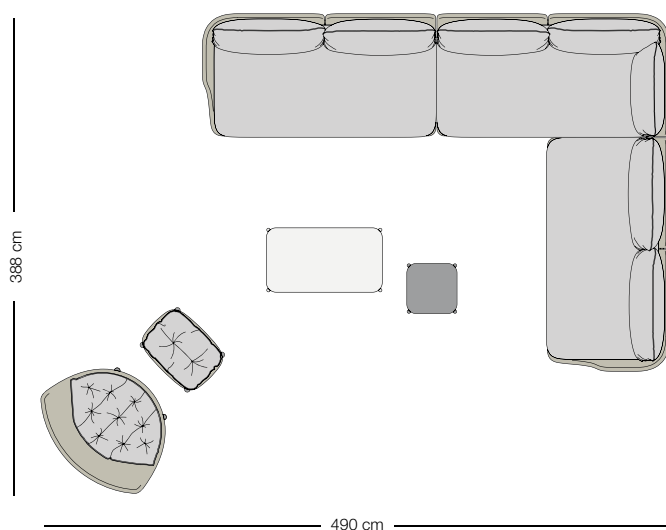

MBARQ Setting 02

- 1x **109003** – Right module, Dry+ cushion set
- 1x **109006** – Left corner module, Dry+ cushion set
- 1x **109005** – Left module, Dry+ cushion set
- 9x **95109290** – Dry+ additional back cushions

1x **937060344** – IZON coffee table, 50 x 90 cm, black pepper/lava

1x **926010084** – IZON side table, 39 x 39 cm, terracotta/glass terracotta

1x **085004** - MBRACE wing chair, seat cushion

1x **085032** - MBRACE footstool, seat cushion

Recommended deco cushions:

- 5x **95050081** – 40 x 40 cm
- 4x **95050082** – 50 x 50 cm

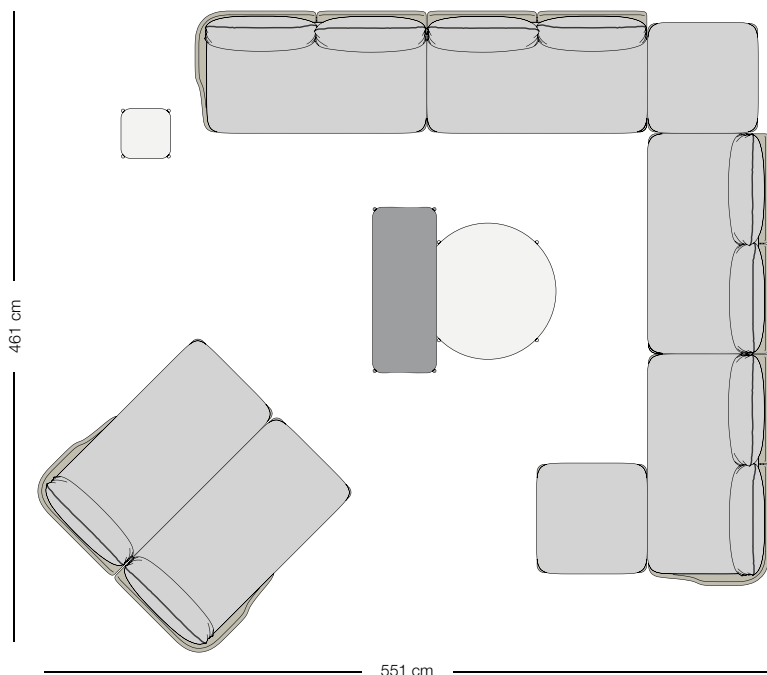

MBARQ Setting 03

- 1x **109003** – Right module, Dry+ cushion set
- 2x **109001** – Center module, Dry+ cushion set
- 1x **109005** – Left module, Dry+ cushion set
- 2x **109035** – Footstool, Dry+ seat cushion
- 1x **109018** – Daybed right, Dry+ cushion set
- 1x **109017** – Daybed left, Dry+ cushion set
- 15x **95109290** – Dry+ additional back cushions

1x **937050344** - IZON coffee table, ø 111 cm, black pepper/lava

1x **937070344** - IZON coffee table, 50 x 130 cm, black pepper/lava

1x **926010084** – IZON side table, 39 x 39 cm, terracotta/glass terracotta

Recommended deco cushions:

- 5x **95050081** – 40 x 40 cm
- 4x **95050082** – 50 x 50 cm



Fiber by item

Lounge chair, wing chair, rocking chair,
 footstool, armchair, daybed

Lounge chair, wing chair,
 rocking chair, footstool

Armchair

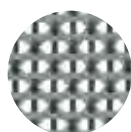
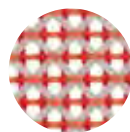
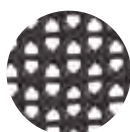

115
pepper

126
arabica

112
spice

141
baltic

151
chestnut

140
sea salt

Recommended combinations



+

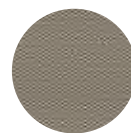

115
pepper

452
COOL taupe
Cat. A

661
TWIST sand
Cat. B

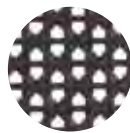

+

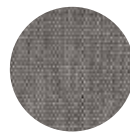
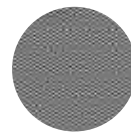

126
arabica

458
COOL ash
Cat. A

662
TWIST gray
Cat. B

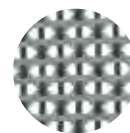

+

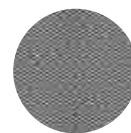

141
baltic

458
COOL ash
Cat. A

664
TWIST
dark turquoise
Cat. B

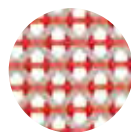

+

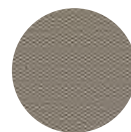

112
spice

452
COOL taupe
Cat. A

661
TWIST sand
Cat. B



+



151
chestnut

462
COOL sage
Cat. A

663
TWIST terracotta
Cat. B



+

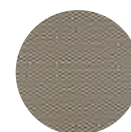

140
sea salt

452
COOL taupe
Cat. A

661
TWIST sand
Cat. B

WING CHAIR
 Hochlehner
 Sillón orejero
 Poltrona con schienale alto
 Fauteuil bergère
 8,6 kg 0,92 m³



085004115

HEADREST CUSHION
 Nackenkissen
 Cojín reposacabezas
 Cuscino poggiatesta
 Coussin repose-tête
 44 x 27 x 7,5 cm

95085005

SEAT CUSHION
 Sitzkissen
 Cojín de asiento
 Cuscino seduta
 Coussin d'assise
 95 x 65 cm

95085016



CUSHION
 Polsterauflage
 Cojín
 Cuscino
 Coussin matelassé
 105 x 140 cm

95085004

56085004000



085004126



085004141



085004112



085004151



RECOMMENDED NUMBER OF DECO CUSHIONS FOR LOUNGE CHAIR, WING CHAIR AND ROCKING CHAIR WITH SEAT CUSHION.

Empfohlene Dekokissenmenge für Sessel, Hochlehner und Schaukelstuhl mit Sitzkissen.

Número de cojines decoración recomendados para sillón bajo, sillón orejero y mecedora con cojín de asiento.

Numero di cuscini decorativi per poltrona club, poltrona con schienale alto e sedia a dondolo con cuscino seduta.

Nombre de coussins déco recommandé pour fauteuil club, fauteuil bergère et fauteuil à bascule avec coussin d'assise.

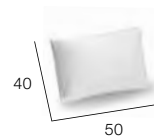

1x 95050085

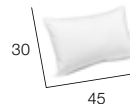

1x 95050089

ROCKING CHAIR
Schaukelstuhl
Mecedora
Sedia a dondolo
Fauteuil à bascule
9,9 kg 1,01 m³



085008115

HEADREST CUSHION
Nackenkissen
Cojín reposacabezas
Cuscino poggiatesta
Coussin repose-tête
44 x 27 x 7,5 cm

95085005

SEAT CUSHION
Sitzkissen
Cojín de asiento
Cuscino seduta
Coussin d'assise
95 x 65 cm

95085016



CUSHION
Polsterauflage
Cojín
Cuscino
Coussin matelassé
105 x 140 cm



95085004

56085004000



085008126



085008141



085008112



085008151



EN The MBRACE collection comes in a mix of materials. The seats consist of DEDON Fiber woven over an aluminum frame, while the bases and dining tables are made of premium teak. The **cushions** of the wing chair, lounge chair, rocking chair and daybed are quilted, which keeps the filling in place and supports the longevity of their luxurious embrace. While the covers cannot be removed, the complete cushions may be washed by hand at 30°C. Cushions of wing chair, lounge chair and rocking chair and the back cushion of armchair come with a cushion holder, while seat cushions do not. The protective cover is tailored to protect the fiber seat and cushions only. The **tabletops** of the side tables are made of Monolite Ipergres®, a frost-proof ceramic material that is non-absorbing and highly resistant to indirect tensile stress, impacts, scratches and abrasion.

DE Die Kollektion MBRACE besteht aus einem Mix aus Materialien: Die Sitzflächen sind aus DEDON-Faser gefertigt, die auf einem Aluminiumrahmen geflochten ist. Die Untergestelle und Esstische sind aus hochwertigem Teakholz gefertigt. Die **Kissen** von Hochlehner, Sessel, Schaukelstuhl und Daybed sind gesteppt, um die weiche Füllung zu unterstützen. Daher können die Kissenhüllen nicht abgezogen werden, die kompletten Kissen können jedoch als Handwäsche bei 30°C gewaschen werden. Die Polsterauflagen von Hochlehner, Sessel und Schaukelstuhl sowie das Rückenkissen vom Armlehnstuhl sind mit Kissenhaltern ausgestattet, die Sitzkissen nicht. Die Husse dient nur zum Schutz der geflochtenen Sitze und der Kissen. Die **Tischplatten** der Beistelltische werden aus Monolite Ipergres® gefertigt, einem frostsicheren, wasserabweisenden Keramikmaterial mit ausgezeichneter Kratz- und Abriebfestigkeit.

ES La colección MBRACE ofrece una interesante mezcla de materiales. La superficie de los asientos está fabricada con tejido trenzado DEDON sobre una estructura de aluminio, mientras que las bases y las mesas comedor son de teca de excelente calidad. Los **cojines** de los sillones orejeros, sillones mecedoras, así como de las sillas con brazos tienen un lazo para su sujeción, mientras que los cojines del asiento no lo tienen. La funda protectora está diseñada para proteger las sillas de fibra y los cojines. Los **tableros de las mesas** auxiliares están hechos de Monolite Ipergres®, un material de cerámica resistente a las heladas, no absorbente y que ofrece una excelente resistencia al peso, a los golpes, a los arañazos y a la abrasión.

IT La collezione MBRACE è offerta in un mix di materiali. Le sedute sono in fibra DEDON, intrecciata su un telaio in alluminio, mentre le basi e i tavoli da pranzo sono in teak di alta qualità. I **cuscini** della poltrona con schienale alto, della poltrona lounge, della sedia a dondolo e del daybed sono trapuntati per sostenere l'imbottitura e favorire la longevità del suo lussuoso abbraccio. I cuscini non sono sfoderabili, ma possono essere lavati a mano a 30°C. I cuscini delle poltrone con schienale alto, delle poltrone lounge, delle poltrone a dondolo e il cuscino dello schienale delle poltrone sono dotati di un supporto antiscivolo, che invece non è previsto per le sedute. La fodera ha la sola funzione di proteggere la seduta in fibra e il cuscino. I **ipiani dei tavolini** d'appoggiosono in Monolite Ipergres®, un materiale ceramico antigelo, impermeabile, caratterizzato da un'eccellente resistenza alle sollecitazioni indirette, agli urti, ai graffi e all'abrasione.

FR La collection MBRACE est le résultat d'un mélange de matières et de matériaux. Les fauteuils sont composés de fibre DEDON tressée sur un cadre en aluminium, tandis que les bases et les tables repas sont en teak de qualité supérieure. Les **coussins** du fauteuil bergère, du fauteuil club, du fauteuil à bascule et du daybed sont matelassés, afin de maintenir leur garniture en place et de garantir la longévité de leur étroite généreuse. Bien que les housses ne peuvent pas être retirées, les coussins entiers sont, eux, lavables à la main à 30°C. Contrairement aux coussins d'assise, les coussins matelassés du fauteuil bergère, du fauteuil club et du fauteuil à bascule, ainsi que le coussin de dossier du fauteuil repas sont équipés de sangles de fixation. La housse de protection est uniquement destinée à protéger les fauteuils et les coussins. Les **plateaux de tables** d'appoint sont en Monolite Ipergres®, un matériau céramique résistant au gel, non absorbant et hautement résistant aux contraintes de traction indirectes, aux chocs, aux rayures et à l'abrasion.

LOUNGE CHAIR

Sessel
Sillón bajo
Poltrona club
Fauteuil club
7,6 kg 0,25 m³



085006115

SEAT CUSHION

Sitzkissen
Cojín de asiento
Cuscino seduta
Cousin d'assise
95 x 65 cm



95085016

CUSHION

Polsterauflage
Cojín
Cuscino
Cousin matelassé
110 x 115 cm



95085006

56085006000



085006126



085006141



085006112



085006151



FOOTSTOOL
Hocker
Taburete
Pouf
Repose-pieds
2,6 kg 0,11 m³

SEAT CUSHION
Sitzkissen
Cojín de asiento
Cuscino seduta
Coussin d'assise
62 x 45 cm



085032

085032115

95085032

56085032000



085032126



085032141



085032112



085032151

DAYBED
 Daybed
 Daybed
 Daybed
 Daybed
 Daybed
 14,4 kg 1,35 m³



085018115



CUSHION
 Polsterauflage
 Cojin
 Cuscino
 Coussin matelassé
 105 x 140 cm



085018

95085018

56085018000



085018126



COFFEE TABLE
 Kaffeetisch
 Mesa de centro
 Tavolino da salotto
 Table de salon
Ø 70 cm
 17,2 kg 0,17 m³



085038300



085038308



34,5

Ø 70 cm
 085038341



085038

56085038000

SIDE TABLE
 Beistelltisch
 Mesa auxiliar
 Tavolino d'appoggio
 Table d'appoint
Ø 50 cm
 9,2 kg 0,11 m³



085036300



085036308



45,5

Ø 50 cm
 085036341



085036

56085036000

SIDE TABLE
 Beistelltisch
 Mesa auxiliar
 Tavolino d'appoggio
 Table d'appoint
Ø 35 cm
 6,2 kg 0,06 m³



085034300



085034308



50,5

Ø 35 cm
 085034341



085034

56085034000

Tabletops ceramic



300 chalk

308 taupe

341 black

ARMCHAIR
 Armlehnstuhl
 Silla con brazos
 Poltrona pranzo
 Fauteuil repas
 5,6 kg 0,3 m³



085001115



SEAT CUSHION
 Sitzkissen
 Cojín de asiento
 Cuscino seduta
 Coussin d'assise
 46,5 x 46,5 cm



95085001

SEAT CUSHION + BACK CUSHION
 Sitzkissen + Rückenkissen
 Cojín de asiento + Cojín de respaldo
 Cuscino seduta + Cuscino schienale
 Coussin d'assise + Coussin de dossier
 46,5 x 46,5 cm + 58,5 x 36,5 cm



95085003

56085001000



085001126



085001140



DINING TABLE
 Esstisch
 Mesa comedor
 Tavolo pranzo
 Table repas
200 x 90 cm
 40 kg 1,35 m³



085065205



4+2



085065

56085065000

DINING TABLE
 Esstisch
 Mesa comedor
 Tavolo pranzo
 Table repas
270 x 90 cm
 51 kg 1,83 m³



085055205



6+2



085055

56085055000

Tabletop teak



205 Teak











Fiber: chestnut
Seat cushion: TWIST terracotta



Right module XXL
 Daybed left
 Cushion: COOL taupe
 Coffee table 90 x 90 cm

Recommended combinations

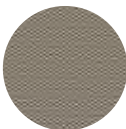
Fiber	Powder coating	Recommended fabrics	
			
111 accona	304 lipari	+	462 COOL sage Cat. A
			683 MAR ash Cat. B

Fiber	Powder coating	Recommended fabrics	
			
099 vulcano	305 vulcano	+	452 COOL taupe Cat. A
			683 MAR ash Cat. B

LOUNGE CHAIR

Sessel
Sillón bajo
Poltrona club
Fauteuil club
28 kg 0,73 m³



SEAT CUSHION + BACK CUSHION
Sitzkissen + Rückenkissen
Cojín de asiento + Cojín de respaldo
Cuscino seduta + Cuscino schienale
Coussin d'assise + Coussin de dossier
69 × 65 cm + 259 × 48 cm



067001

067001111

067001099

95067001

56067001000

LEFT MODULE

Modul links
Módulo izquierdo
Modulo sinistro
Module gauche
29 kg 0,99 m³



SEAT CUSHION + BACK CUSHIONS
Sitzkissen + Rückenkissen
Cojín de asiento + Cojines de respaldo
Cuscino seduta + Cuscini schienale
Coussin d'assise + Coussins de dossier
132 × 65 cm + 228 × 48 cm



067005

067005111

067005099

95067005

56067005000

RIGHT MODULE

Modul rechts
Módulo derecho
Modulo destro
Module droit
29 kg 0,99 m³



SEAT CUSHION + BACK CUSHIONS
Sitzkissen + Rückenkissen
Cojín de asiento + Cojines de respaldo
Cuscino seduta + Cuscini schienale
Coussin d'assise + Coussins de dossier
132 × 65 cm + 228 × 48 cm



067003

067003111

067003099

95067003

56067003000

LEFT MODULE XXL

Modul links XXL
Módulo izquierdo XXL
Modulo sinistro XXL
Module gauche XXL
35 kg 1,41 m³



SEAT CUSHION + BACK CUSHIONS
Sitzkissen + Rückenkissen
Cojín de asiento + Cojines de respaldo
Cuscino seduta + Cuscini schienale
Coussin d'assise + Coussins de dossier
197 × 65 cm + 293 × 48 cm



067006

067006111

067006099

95067006

56067006000

RIGHT MODULE XXL

Modul rechts XXL
Módulo derecho XXL
Modulo destro XXL
Module droit XXL
35 kg 1,41 m³



SEAT CUSHION + BACK CUSHIONS
Sitzkissen + Rückenkissen
Cojín de asiento + Cojines de respaldo
Cuscino seduta + Cuscini schienale
Coussin d'assise + Coussins de dossier
197 × 65 cm + 293 × 48 cm



067004

067004111

067004099

95067004

56067004000

CENTER MODULE

Modul mitte
Módulo centro
Modulo centrale
Module central
24 kg 0,83 m³



SEAT CUSHION + BACK CUSHIONS
Sitzkissen + Rückenkissen
Cojín de asiento + Cojines de respaldo
Cuscino seduta + Cuscini schienale
Coussin d'assise + Coussins de dossier
130 × 65 cm + 130 × 48 cm



067011

067011111

067011099

95067011

56067011000

RECOMMENDED DECO CUSHIONS

Empfohlene Dekokissen
Cojines decoración recomendados
Cuscini decorativi consigliati
Coussins déco recommandés

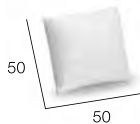

95050082

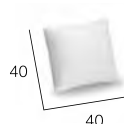

95050081

CENTER MODULE, INCL. SHELF LEFT

Modul mitte, Ablage links

Módulo central, incluida repisa izquierda

Modulo centrale, incl. mensola sinistra

Module central, incl. étagère gauche

27,5 kg 1,0 m³

067122111



067122099

SEAT CUSHION + BACK CUSHIONS

Sitzkissen + Rückenkissen

Cojín de asiento + Cojines de respaldo

Cuscino seduta + Cuscini schienale

Coussin d'assise + Coussins de dossier

130 x 65 cm + 130 x 48 cm

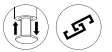

067122

95067011

56067022000

CENTER MODULE, INCL. SHELF RIGHT

Modul mitte, Ablage rechts

Módulo central, incluida repisa derecha

Modulo centrale, incl. mensola destra

Module central, incl. étagère droite

27,5 kg 1,0 m³

067123111



067123099

SEAT CUSHION + BACK CUSHIONS

Sitzkissen + Rückenkissen

Cojín de asiento + Cojines de respaldo

Cuscino seduta + Cuscini schienale

Coussin d'assise + Coussins de dossier

130 x 65 cm + 130 x 48 cm

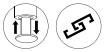

067123

95067011

56067023000

CENTER MODULE XXL

Modul mitte XXL

Módulo centro XXL

Modulo centrale XXL

Module central XXL

31 kg 1,25 m³

067012111



067012099

SEAT CUSHION + BACK CUSHIONS

Sitzkissen + Rückenkissen

Cojín de asiento + Cojines de respaldo

Cuscino seduta + Cuscini schienale

Coussin d'assise + Coussins de dossier

195 x 65 cm + 195 x 48 cm

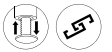

067012

95067012

56067012000

4-SEATER

4er-Sofa

Sofá 4 plazas

Divano 4 posti

Canapé 4 places

39 kg 1,57 m³

067015111



067015099

SEAT CUSHION + BACK CUSHIONS

Sitzkissen + Rückenkissen

Cojín de asiento + Cojines de respaldo

Cuscino seduta + Cuscini schienale

Coussin d'assise + Coussins de dossier

199 x 65 cm + 390 x 48 cm



067015

95067015

56067015000

DAYBED LEFT

Daybed links

Daybed izquierdo

Daybed sinistro

Daybed gauche

28,5 kg 0,99 m³

067017111



067017099

SEAT CUSHION + BACK CUSHION

Sitzkissen + Rückenkissen

Cojín de asiento + Cojín de respaldo

Cuscino seduta + Cuscino schienale

Coussin d'assise + Coussin de dossier

130 x 90 cm + 163 x 48 cm

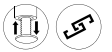

067017

95067017

56067017000

DAYBED RIGHT

Daybed rechts

Daybed derecho

Daybed destro

Daybed droit

28,5 kg 0,99 m³

067018111



067018099

SEAT CUSHION + BACK CUSHION

Sitzkissen + Rückenkissen

Cojín de asiento + Cojín de respaldo

Cuscino seduta + Cuscino schienale

Coussin d'assise + Coussin de dossier

130 x 90 cm + 163 x 48 cm

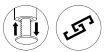

067018

95067018

56067018000

DAYBED, INCL. SHELF LEFT

Daybed, Ablage links
Daybed izquierdo, incluida repisa izquierda
Daybed, incl. mensola sinistra
Daybed, incl. étagère gauche
36,4 kg 1,6 m³



067124111



067124099

SEAT CUSHION + BACK CUSHION
Sitzkissen + Rückenkissen
Cojín de asiento + Cojín de respaldo
Cuscino seduta + Cuscino schienale
Coussin d'assise + Coussin de dossier
172 x 91,5 x 20 cm + 90 x 51 x 20 cm

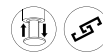

067124 067124111 067124099 95067024 56067024000

DAYBED, INCL. SHELF RIGHT

Daybed, Ablage rechts
Daybed derecho, incluida repisa derecha
Daybed, incl. mensola destra
Daybed, incl. étagère droite
36,4 kg 1,6 m³



067125111



067125099

SEAT CUSHION + BACK CUSHION
Sitzkissen + Rückenkissen
Cojín de asiento + Cojín de respaldo
Cuscino seduta + Cuscino schienale
Coussin d'assise + Coussin de dossier
172 x 91,5 x 20 cm + 90 x 51 x 20 cm



067125 067125111 067125099 95067024 56067025000

FOOTSTOOL / COFFEE TABLE

Hocker / Kaffeetisch
Reposapiés / Mesa de centro
Pouf / Tavolino da salotto
Repose-pieds / Table de salon
90 x 90 cm
18 kg 0,24 m³



067016111

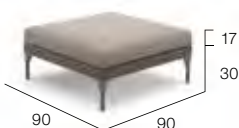

067016099

SEAT CUSHION
Sitzkissen
Cojín de asiento
Cuscino seduta
Coussin d'assise
90 x 90 cm

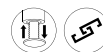

067016 067016111 067016099 95067016 56067030000



Set: 067116111

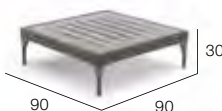

Set: 067116099

HPL LIPARI 2.0
HPL lipari 2.0
HPL lipari 2.0
HPL lipari 2.0
HPL lipari 2.0
HPL lipari 2.0
6,6 kg

HPL VULCANO
HPL vulcano
HPL vulcano
HPL vulcano
HPL vulcano
HPL vulcano
6,6 kg



24467016306

24467016305

56067016000



Set: 067216111

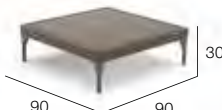

Set: 067216099

GLASS LIPARI
Glas lipari
Sobre de cristal lipari
Piano in vetro lipari
Plaque en verre lipari
13,5 kg

GLASS VULCANO
Glas vulcano
Sobre de cristal vulcano
Piano in vetro vulcano
Plaque en verre vulcano
13,5 kg

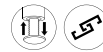

22267016304

22267016305

56067016000

FOOTSTOOL / COFFEE TABLE

Hocker / Kaffeetisch
 Reposapiés / Mesa de centro
 Pouf / Tavolino da salotto
 Repose-pieds / Table de salon
90 x 130 cm
 22 kg 0,35 m³

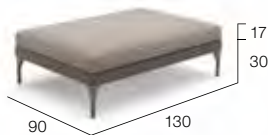

SEAT CUSHION
 Sitzkissen
 Cojín de asiento
 Cuscino seduta
 Coussin d'assise
 90 x 130 cm



067013

067013111

067013099

95067013

56067031000

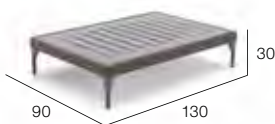

HPL LIPARI 2.0
 HPL lipari 2.0
 HPL lipari 2.0
 HPL lipari 2.0
 HPL lipari 2.0
 HPL lipari 2.0
 9,9 kg

HPL VULCANO
 HPL vulcano
 HPL vulcano
 HPL vulcano
 HPL vulcano
 HPL vulcano
 9,9 kg



Set: 067113111

Set: 067113099

24467013306

24467013305

56067013000

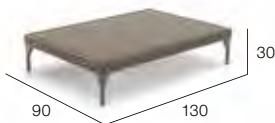

GLASS LIPARI
 Glas lipari
 Sobre de cristal lipari
 Piano in vetro lipari
 Plaque en verre lipari
 20 kg

GLASS VULCANO
 Glas vulcano
 Sobre de cristal vulcano
 Piano in vetro vulcano
 Plaque en verre vulcano
 20 kg



Set: 067213111

Set: 067213099

22267013304

22267013305

56067013000

BEACH CHAIR *
 Sonnenliege
 Tumbona
 Lettino
 Chaise longue
 28,5 kg 0,44 m³



CUSHION
 Kissen
 Cojín
 Cuscino
 Coussin
 75 x 195 cm



067019

067019111

067019099

95067019

56067019000

Tabletops HPL



306 lipari 2.0

305 vulcano

Tabletops glass



304 lipari glass

Bottom: lacquered in lipari

305 vulcano glass

Bottom: lacquered in vulcano

* EN This item is also available with hook-catching mechanism upon request.

DE Dieser Artikel ist auf Anfrage auch mit Stufenverstellung erhältlich.

ES Bajo pedido este artículo también está disponible con un mecanismo de ajuste escalonado.

IT Questo articolo è disponibile su richiesta anche con meccanismo di regolazione reclinabile.

FR Cet article est disponible, sur demande, avec un mécanisme de réglage du niveau d'inclinaison.



Center module, incl. shelf right, accona
Cushion: COOL taupe

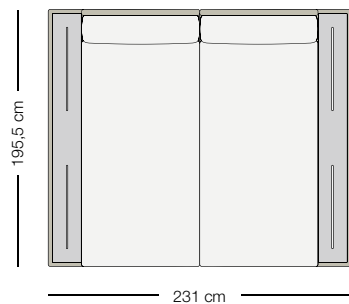

MU Setting 01

- 1x **067125** – Daybed, incl. shelf right, seat cushion + back cushion
- 1x **067127** – Daybed, incl. shelf left, seat cushion + back cushion

Recommended deco cushions:

- 3x **95050081** – 40 x 40 cm
- 2x **95050082** – 50 x 50 cm

For inspiration please see DEDON Lookbook 2020, pages 16 and 51

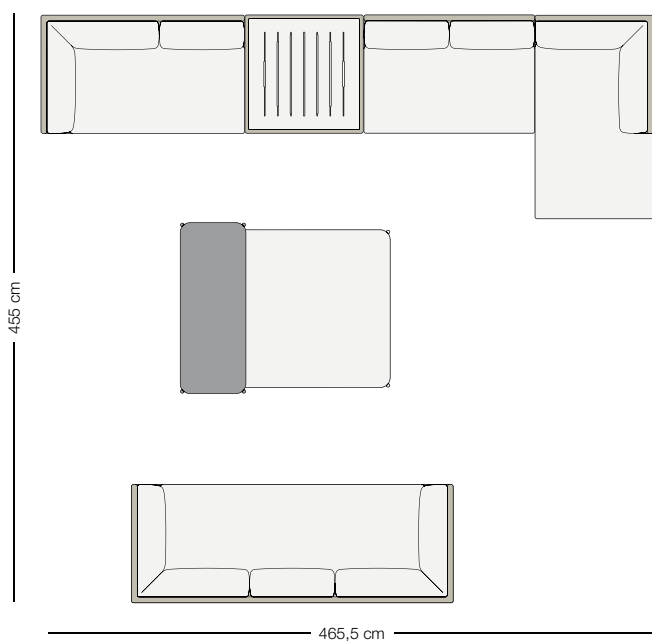

MU Setting 02

- 1x **067003** – Right module, seat cushion + back cushions
- 1x **067116** – Coffee table 90 x 90 cm, HPL top
- 1x **067011** – Center module, seat cushion + back cushions
- 1x **067017** – Daybed left, seat cushion + back cushion
- 1x **067015** – 4-seater, seat cushion + back cushions

- 1x **933040343** – IZON coffee table, 120 x 120 cm, lipari/talc
- 1x **933060343** – IZON coffee table, 50 x 130 cm, lipari/talc

Recommended deco cushions:

- 6x **95050081** – 40 x 40 cm
- 5x **95050082** – 50 x 50 cm

For inspiration please see DEDON Lookbook 2020, page 50

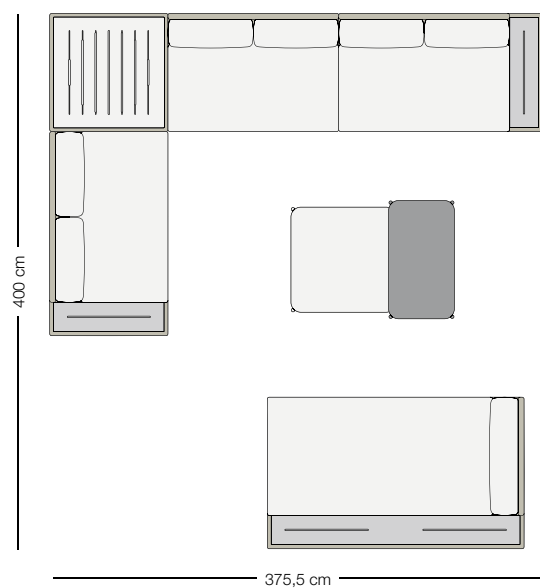

MU Setting 03

- 1x **067123** – Center module, incl. shelf right, seat cushion + back cushions
- 1x **067116** – Coffee table 90 x 90 cm, HPL top
- 1x **067011** – Center module, seat cushion + back cushions
- 1x **067122** – Center module, incl. shelf left, seat cushion + back cushions
- 1x **067124** – Daybed, incl. shelf left, seat cushion + back cushion

- 1x **933030343** – IZON coffee table, 80 x 80 cm, lipari/talc
- 1x **937060344** – IZON coffee table, 50 x 90 cm, black pepper/lava

Recommended deco cushions:

- 4x **95050081** – 40 x 40 cm
- 5x **95050082** – 50 x 50 cm

For inspiration please see DEDON Lookbook 2020, pages 48/49

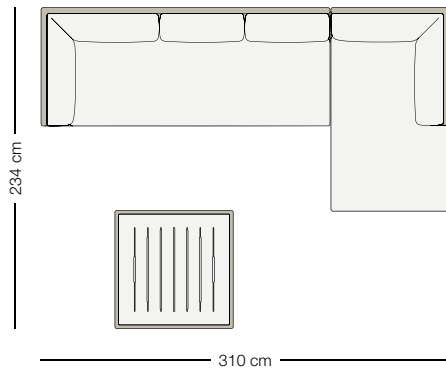

MU Setting 04

- 1x **067004** – Right module XXL, seat cushion + back cushions
- 1x **067017** – Daybed left, seat cushion + back cushion
- 1x **067116** – Coffee table 90 x 90 cm, HPL top

Recommended deco cushions:

- 2x **95050081** – 40 x 40 cm
- 1x **95050082** – 50 x 50 cm

For inspiration please see page 88

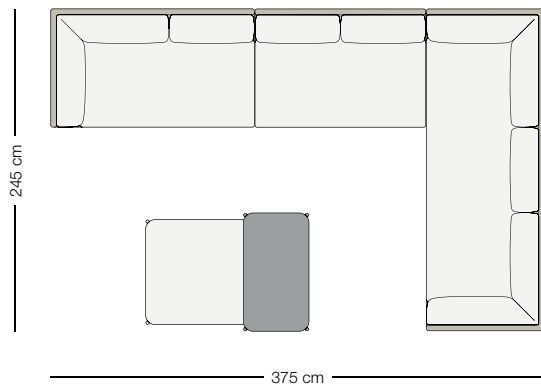

MU Setting 05

- 1x **067003** – Right module, seat cushion + back cushions
- 1x **067011** – Center module, seat cushion + back cushions
- 1x **067015** – 4-seater, seat cushion + back cushions

- 1x **933030343** – IZON coffee table, 80 x 80 cm, lipari/talc
- 1x **937060344** – IZON coffee table, 50 x 90 cm, black pepper/lava

Recommended deco cushions:

- 5x **95050081** – 40 x 40 cm
- 5x **95050082** – 50 x 50 cm

For inspiration please see DEDON Lookbook 2020, page 17

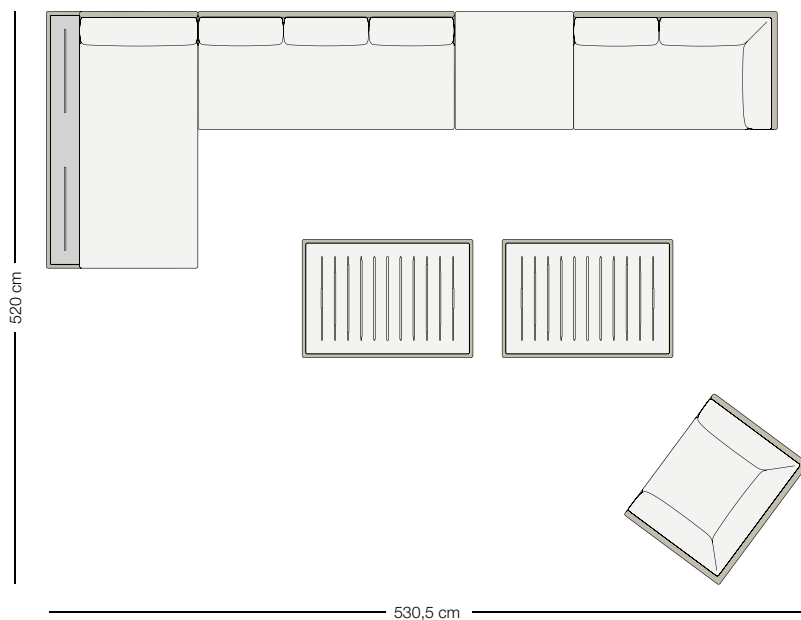

MU Setting 06





- 1x **067125** – Daybed, incl. shelf right, seat cushion + back cushion
- 1x **067012** – Center module XXL, seat cushion + back cushions
- 1x **067016** – Footstool, seat cushion
- 1x **067005** – Left module, seat cushion + back cushions
- 1x **067001** – Lounge chair, seat cushion + back cushion
- 2x **067113** – Coffee table 90 x 130 cm, HPL top





Recommended deco cushions:

- 3x **95050081** – 40 x 40 cm
- 2x **95050082** – 50 x 50 cm

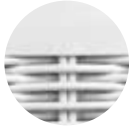

Recommended combinations

Fiber	Powder coating	Recommended fabrics		
		+		
002 natural	304 lipari		450 COOL white Cat. A	660 TWIST beige Cat. B

Fiber	Powder coating	Recommended fabrics		
		+		
083 chalk	304 lipari		450 COOL white Cat. A	660 TWIST beige Cat. B

HANGING LOUNGER *

Hanging lounger
 Hanging lounger
 Hanging lounger
 Hanging lounger
ø 200 cm
 85,5 kg 10,7 m³

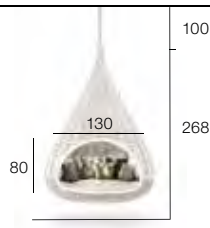
090919**002**090919**083**

SEAT CUSHION
 Sitzkissen
 Cojín de asiento
 Cuscino seduta
 Coussin d'assise
 ø 188 x 13,5 cm

**090019****95090219****6600000863****STANDING LOUNGER, INCL. BASE ***

Standing lounger, inkl. Untersatz
 Standing lounger, base incl.
 Standing lounger, base incl.
 Standing lounger, avec socle
ø 200 cm
 99,5 kg 11,8 m³

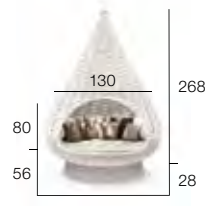
090023**002**090023**083**

SEAT CUSHION
 Sitzkissen
 Cojín de asiento
 Cuscino seduta
 Coussin d'assise
 ø 188 x 13,5 cm

**090023****95090219****6000000863****BASE, SUITABLE FOR HANGING AND STANDING LOUNGER**

Untersatz, passend für Hanging und Standing lounger
 Base, adaptable para el hanging y standing lounger
 Base, adatta per Hanging e Standing lounger
 Socle, convient pour Hanging lounger et Standing lounger
 14 kg 0,34 m³

090018**002**090018**083****090018****RECOMMENDED NUMBER OF DECO CUSHIONS**

Empfohlene Dekokissenmenge
 Número de cojines decoración recomendados
 Numero di cuscini decorativi
 Nombre de coussins déco recommandé

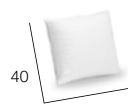

60

8x 95050**087**

40

4x 95050**081**

EN Hanging and standing lounger do not fit through standard doors! **DE** Hanging und Standing Lounger passen nicht durch Türen mit Standardabmessungen! **ES** Debido a las dimensiones de este producto se recomienda verifiquen la accesibilidad! **IT** Hanging e Standing lounger non passano attraverso le normali porte! **FR** Ni le Hanging lounger ni le Standing lounger ne passent par des portes standard !

* **EN** Weight capacity 350 kg **DE** Tragkraft 350 kg **ES** Capacidad de carga 350 kg **IT** Portata 350 kg **FR** Capacité de charge 350 kg

** **EN** Cover is tailored to protect seat and deco cushions only. **DE** Die Husse dient nur zum Schutz der Sitzfläche und der Dekokissen. **ES** La funda está confeccionada para proteger el asiento y los cojines decorativos únicamente. **IT** La housse è confezionata in modo da proteggere esclusivamente la seduta e i cuscini decorativi. **FR** La housse est uniquement destinée à protéger le siège et les coussins décos.









EN The NESTREST is shipped with pre-mounted handles. **DE** Das NESTREST wird inkl. vormontierter Griffe geliefert. **ES** El NESTREST se entrega con asas de transporte desmontables. **IT** NESTREST viene fornito con impugnatura premontata. **FR** Le NESTREST est fourni avec des poignées de transport prémontées.



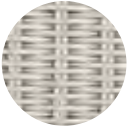
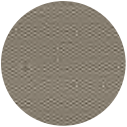

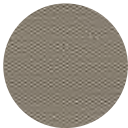
Loveseat, accona
Cushion: COOL white

Recommended combinations

	+					+		
040 bronze		450 COOL white Cat. A	661 TWIST sand Cat. B		083 chalk		452 COOL taupe Cat. A	662 TWIST gray Cat. B
	+					+		
099 vulcano		452 COOL taupe Cat. A	683 MAR ash Cat. B		111 accona		462 COOL sage Cat. A	683 MAR ash Cat. B

LOVESEAT
Sofainsel
Sofá isla
Isola 2 posti
L'îlot călin
ø 165 cm
32 kg 2,6 m³



193



ø 165

030008083

SEAT CUSHION
Sitzkissen
Cojín de asiento
Cuscino seduta
Coussin d'assise
ø 127 cm



030008

030008040

95030001

56030003000



030008099



030008111

RECOMMENDED NUMBER OF DECO CUSHIONS

Empfohlene Dekokissenmenge
Número de cojines decoración recomendados
Numero di cuscini decorativi
Nombre de coussins déco recommandé

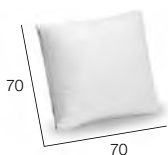

2x 95050086

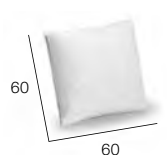

2x 95050084

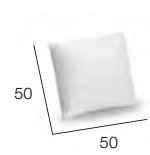

2x 95050082



2x 95050081

LOVESEAT XXL
Sofainsel XXL
Sofá isla XXL
Isola 2 posti XXL
L'îlot călin XXL
ø 220 cm
89 kg 4,84 m³



030011040



030011083

215



ø 220

030111083

SEAT CUSHION
Sitzkissen
Cojín de asiento
Cuscino seduta
Coussin d'assise
ø 184 cm



95030004

56030006000



030011099



030011111



030111111

RECOMMENDED NUMBER OF DECO CUSHIONS

Empfohlene Dekokissenmenge
Número de cojines decoración recomendados
Numero di cuscini decorativi
Nombre de coussins déco recommandé

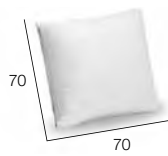

4x 95050086

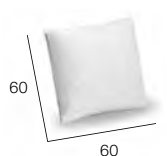

4x 95050084

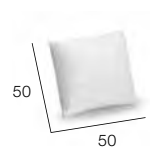

2x 95050082

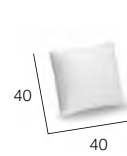

2x 95050081

EN The loveseat / loveseat XXL is shipped with pre-mounted pullout casters. **DE** Die Sofainsel / Sofainsel XXL wird inkl. vormontierter ausklappbarer Räder geliefert. **ES** El sofá isla / El sofá isla XXL se entrega con ruedas premontadas plegables. **IT** L'isola / L'isola XXL viene fornita completa di ruote pieghevoli. **FR** L'îlot călin / L'îlot călin XXL sont fournis avec des roues prémontées escamotables.

EN ORBIT comes with a seat consisting of sling material. **DE** Bei ORBIT besteht die Sitzfläche unter dem Sitzkissen aus Sling-Material. **ES** Los asientos de ORBIT están compuestos de material de tensor. **IT** ORBIT è realizzata con seduta in fettuccia. **FR** Le siège d'ORBIT est fabriqué dans un matériau élastique.





Armchair
Side chair
Cushion: TWIST gray

Recommended combinations



040
bronze

+



450
COOL white
Cat. A

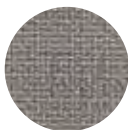

652
LINEN
warm gray
Cat. B

ARMCHAIR
 Armlehnstuhl
 Silla con brazos
 Poltrona pranzo
 Fauteuil repas
 7 kg 0,35 m³

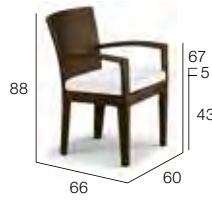

022001040

SEAT CUSHION
 Sitzkissen
 Cojín de asiento
 Cuscino seduta
 Coussin d'assise
 58 x 48 cm



022001

95022001

56022001000

SIDE CHAIR
 Essstuhl
 Silla de comedor
 Sedcia pranzo
 Chaise repas
 5 kg 0,25 m³

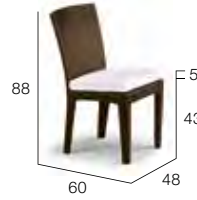

022003040

SEAT CUSHION
 Sitzkissen
 Cojín de asiento
 Cuscino seduta
 Coussin d'assise
 46 x 44 cm



022003

95022003

56022003000

DINING TABLE
 Esstisch
 Mesa comedor
 Tavolo pranzo
 Table repas
 100 x 100 cm
 9,5 kg 0,75 m³

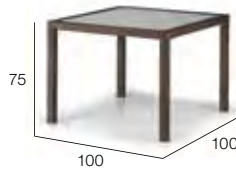

Set: 222270040

SATINATED GLASS TOP
 Satinierte Glasplatte
 Sobre de cristal satinado
 Piano in vetro satinato
 Plaque en verre satinée
 15,5 kg



122270040

2222705000

56027076000

DINING TABLE
 Esstisch
 Mesa comedor
 Tavolo pranzo
 Table repas
 100 x 200 cm
 11 kg 1,5 m³

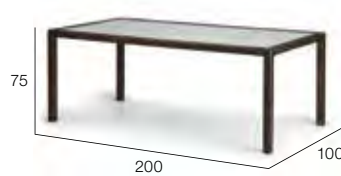

Set: 222120040

SATINATED GLASS TOP
 Satinierte Glasplatte
 Sobre de cristal satinado
 Piano in vetro satinato
 Plaque en verre satinée
 33 kg



122120040

22227065000

56027066000

BARSTOOL
 Barhocker
 Taburete de bar
 Sgabello bar
 Tabouret de bar
 6 kg 0,28 m³



022029040

SEAT CUSHION
 Sitzkissen
 Cojín de asiento
 Cuscino seduta
 Coussin d'assise
 41 x 40 cm



022029

95022028

56022028000

Tabletops glass



000 satinated glass
 Bottom: satinated
 PANAMA Dining table

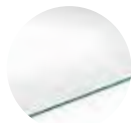

000 clear glass
 PANAMA Side table

LOUNGE CHAIR

Sessel
Sillón bajo
Poltrona club
Fauteuil club
8 kg 0,53 m³

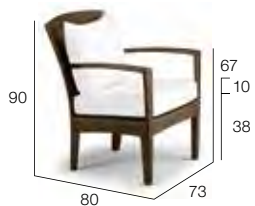

SEAT CUSHION + BACK CUSHION
Sitzkissen + Rückenkissen
Cojín de asiento + Cojín de respaldo
Cuscino seduta + Cuscino schienale
Coussin d'assise + Coussin de dossier
67 x 58 cm + 50 x 60 cm



022005

022005040

95022005

56022005000

SIDE TABLE

Beistelltisch
Mesa auxiliar
Tavolino d'appoggio
Table d'appoint
46 x 46 cm
4 kg 0,1 m³

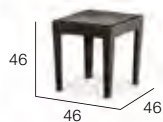

CLEAR GLASS TOP
Klarglasplatte
Sobre de cristal transparente
Piano in vetro trasparente
Plaque en verre clair
3 kg



022033

Set: 022034040

2222033000

56022033000

BEACH CHAIR

Sonnenliege
Tumbona
Lettino
Chaise longue
16 kg 1,05 m³



CUSHION
Kissen
Cojín
Cuscino
Coussin
61 x 196 cm



022020

022020040

95022019

56022019000



PANAMA Armchair
Cushion: TWIST gray



Side chair, carbon & chalk
Side chair, stone & chalk

Fibers

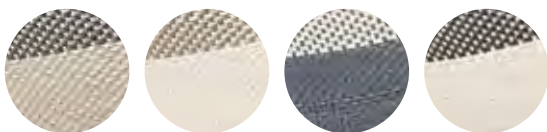

519
platinum &
titanium

521
chalk &
platinum

522
stone &
chalk

516
carbon &
chalk

SIDE CHAIR
Essstuhl
Silla de comedor
Sedia pranzo
Chaise repas
4,2 kg 0,2 m³

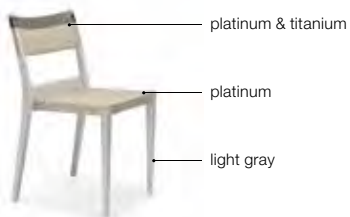

402003519

56400003000

ARMCHAIR
Armlehnstuhl
Silla con brazos
Poltrona pranzo
Fauteuil repas
4,8 kg 0,24 m³

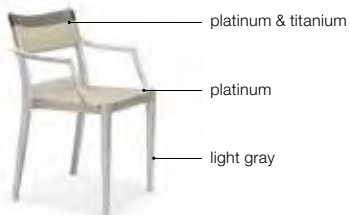

402101519

56400001000

SIDE CHAIR
Essstuhl
Silla de comedor
Sedia pranzo
Chaise repas
4,2 kg 0,2 m³

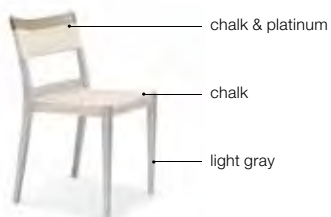

402003521

56400003000

ARMCHAIR
Armlehnstuhl
Silla con brazos
Poltrona pranzo
Fauteuil repas
4,8 kg 0,24 m³

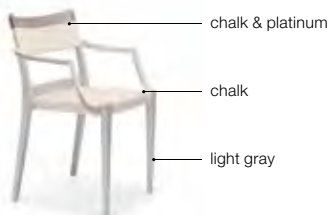

402101521

56400001000

SIDE CHAIR
Essstuhl
Silla de comedor
Sedia pranzo
Chaise repas
4,2 kg 0,2 m³



403003522

56400003000

ARMCHAIR
Armlehnstuhl
Silla con brazos
Poltrona pranzo
Fauteuil repas
4,8 kg 0,24 m³



403101522

56400001000

SIDE CHAIR
 Essstuhl
 Silla de comedor
 Sedia pranzo
 Chaise repas
 4,2 kg 0,2 m³

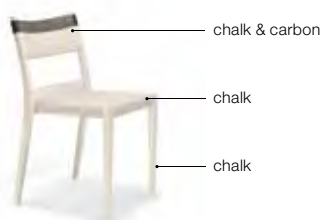

403003516

56400003000

ARMCHAIR
 Armlehnstuhl
 Silla con brazos
 Poltrona pranzo
 Fauteuil repas
 4,8 kg 0,24 m³



403101516

56400001000

EN The frames and armrests of the PLAY armchairs and side chairs consist of injection-molded polypropylene, the perfect material for all weather conditions. The seat and back are woven with DEDON Fiber. Clean with a soft cloth and warm water.

DE Die Rahmen und Armlehnen der PLAY Stühle werden im Spritzgussverfahren aus Polypropylen hergestellt, einem perfekten Material für alle Wetterlagen. Der Sitz und die Rückenlehne sind mit DEDON-Faser beflochten und einfach mit einem weichen Tuch und warmem Wasser zu reinigen.

ES El armazón y los reposabrazos de las butacas y sillas PLAY están hechos de polipropileno moldeado por inyección, que es el material perfecto para todo tipo de condiciones climatológicas. El asiento y el respaldo están trenzados con fibra DEDON. Límpielas con agua tibia y un paño suave.

IT I telai e i braccioli delle sedie PLAY, con e senza braccioli, sono in polipropilene stampato a iniezione, il materiale perfetto per resistere a tutti gli agenti atmosferici. La seduta e lo schienale possono essere in fibra DEDON. Pulire con un panno morbido e acqua tiepida.

FR Les châssis et les accoudoirs des chaises et des fauteuils PLAY sont en polypropylène moulé par injection, une matière idéale pour toutes les conditions climatiques. Le siège et le dossier sont tressés avec la fibre DEDON. Nettoyer avec un chiffon doux imbibé d'eau chaude.





Side table woven base ø 61 cm, marrone
Side table woven base ø 41 cm, carrara
Side table ceramic base ø 51 cm, taupe
Coffee table woven base ø 100 cm, marrone
Side table woven base ø 51 cm, marrone

Woven



116
marrone

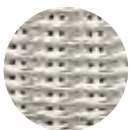

117
carrara

Ceramic



301
black



308
taupe

SIDE TABLE
 Beistelltisch
 Mesa auxiliar
 Tavolino d'appoggio
 Table d'appoint
ø 61 cm
 12,5 kg 0,11 m³



087034116



087034117



087034

56087034000



087034301



087034308

22 kg 0,11 m³

SIDE TABLE
 Beistelltisch
 Mesa auxiliar
 Tavolino d'appoggio
 Table d'appoint
ø 51 cm
 9 kg 0,11 m³



087036116



087036117



087036

56087036000



087036301



087036308

16 kg 0,11 m³

SIDE TABLE
 Beistelltisch
 Mesa auxiliar
 Tavolino d'appoggio
 Table d'appoint
ø 41 cm
 8 kg 0,09 m³



087038116



087038117



087038

56087038000

COFFEE TABLE
 Kaffeetisch
 Mesa de centro
 Tavolino da salotto
 Table de salon
ø 100 cm
 26,9 kg 0,26 m³



087032116



087032117



087032

56087032000

EN The tabletop is made of Monolite Ipergres®, a frost-proof ceramic material that is non-absorbing and highly resistant to indirect tensile stress, impacts, scratches and abrasion. Available in a choice of marrone or carrara, the woven base consists of a mix of DEDON fiber and marine rope, interlaced through a powder coated aluminum structure. Covers are suitable only for PORCINI with woven bases. The warranty for PORCINI is limited to two years.

DE Die Tischplatten werden aus Monolite Ipergres® gefertigt, einem frostsicheren, wasserabweisenden Keramikmaterial mit ausgezeichneter Kratz- und Abriebfestigkeit. Die Untergestelle der Farben Marrone und Carrara bestehen aus einem Mix aus DEDON-Faser und Seilen, eingeflochten in ein pulverbeschichtetes Alugeflecht. Die Hussen können nur für PORCINI Beistelltische mit gewebtem Unterteil verwendet werden. Für PORCINI Möbel gilt eine Garantie von 2 Jahren.

ES El tablero Monolite Ipergres® es un material de cerámica resistente a las heladas y repelente al agua, con una excelente resistencia al peso, los golpes, los arañazos y la abrasión. Disponible en Marrone o Carrara, la base está trenzada con una combinación de fibra DEDON y cuerdas marinas que se entrelazan en una estructura de aluminio con acabado en pintura de polvo. Las fundas son adecuadas únicamente para PORCINI con una base tejida. La garantía de PORCINI se limita a 2 años.



IT Il piano del tavolo è in Monolite Ipergres®, un materiale ceramico antigelo, idrorepellente, caratterizzato da un'eccellente resistenza alle sollecitazioni indirette, agli urti, ai graffi e all'abrasione. Disponibile nelle versioni Marrone e Carrara, la base si compone di un intreccio di fibra DEDON e da corde marine inserito in una struttura di alluminio verniciato a polvere. I teli di copertura sono adatti solo agli arredi PORCINI con base intrecciata. La garanzia di PORCINI è limitata a 2 anni.



FR Le plateau de table est en Monolite Ipergres®, un matériau céramique résistant au gel, qui n'absorbe pas et qui est hautement résistant aux contraintes de traction indirectes, aux rayures et à l'abrasion. Disponible en Marrone ou Carrara, la base tressée est un mélange de fibre DEDON et de corde de bateau, entrelacées à travers une structure en aluminium thermolaqué. Les nappes ne sont adaptées qu'aux tables PORCINI à la base tressée. Les tables PORCINI sont garanties 2 ans.

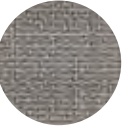

Right module, incl. right armrest
 Left module
 Coffee table 176 x 88 cm
 Cushion: LINEN warm gray

Recommended combinations

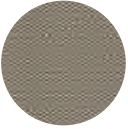
Fiber	Powder coating	Recommended fabrics	
			
079 veneto	305 vulcano	452 COOL taupe Cat. A	652 LINEN warm gray Cat. B

Fiber	Powder coating	Recommended fabrics	
			
085 salina	304 lipari	452 COOL taupe Cat. A	652 LINEN warm gray Cat. B

CORNER MODULE

Eckmodul
Módulo esquina
Modulo d'angolo
Module d'angle
19 kg 0,61 m³



078006085

SEAT CUSHION + BACK CUSHIONS (RIGHT)
Sitzkissen + Rückenkissen (rechts)
Cojín de asiento + Cojines de respaldo (derecho)
Cuscino seduta + Cuscini schienale (destra)
Coussin d'assise + Coussins de dossier (droit)
65 x 65 cm + 168 x 55 cm

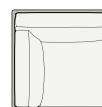
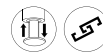

95078016

56078006000

078006



078006079

SEAT CUSHION + BACK CUSHIONS (LEFT)
Sitzkissen + Rückenkissen (links)
Cojín de asiento + Cojines de respaldo (izquierdo)
Cuscino seduta + Cuscini schienale (sinistro)
Coussin d'assise + Coussins de dossier (gauche)
65 x 65 cm + 168 x 55 cm

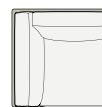

95078006

CENTER MODULE

Modul mitte
Módulo centro
Modulo centrale
Module central
17 kg 0,83 m³



078007085

SEAT CUSHION + BACK CUSHIONS
Sitzkissen + Rückenkissen
Cojín de asiento + Cojines de respaldo
Cuscino seduta + Cuscini schienale
Coussin d'assise + Coussins de dossier
127 x 65 cm + 126 x 55 cm



95078007

56078007000

078007



078007079

LEFT MODULE, INCL. LEFT ARMREST

Modul links, Armlehne links
Módulo izquierdo, brazo izquierdo
Modulo sinistro, bracciolo sinistro
Module gauche, accoudoir gauche incl.
30 kg 1,04 m³



078008085

SEAT CUSHION + BACK CUSHIONS + SIDE CUSHION
Sitzkissen + Rückenkissen + Seitenkissen
Cojín de asiento + Cojines de respaldo + Cojín lateral
Cuscino seduta + Cuscini schienale + Cuscino laterale
Coussin d'assise + Coussins de dossier + Coussin latéral
127 x 65 cm + 144 x 55 cm + 50 x 40 cm



95078008

56078008000

078008



078008079

RECOMMENDED DECO CUSHIONS

Empfohlene Dekokissen
Cojines decoración recomendados
Cuscini decorativi consigliati
Coussins déco recommandés

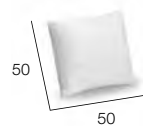

95050082

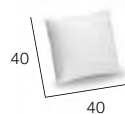

95050081

RIGHT MODULE, INCL. RIGHT ARMREST

Modul rechts, Armlehne rechts
 Módulo derecho, incl. brazo derecho
 Modulo destro, bracciolo destro
 Module droit, accoudoir droit incl.
 30 kg 1,04 m²



078009085

SEAT CUSHION + BACK CUSHIONS + SIDE CUSHION
 Sitzkissen + Rückenkissen + Seitenkissen
 Cojín de asiento + Cojines de respaldo + Cojín lateral
 Cuscino seduta + Cuscini schienale + Cuscino laterale
 Coussin d'assise + Coussins de dossier + Coussin latéral
 127 × 65 cm + 144 × 55 cm + 50 × 40 cm



078009

95078009

56078009000



078009079

LEFT MODULE

Modul links
 Módulo izquierdo
 Modulo sinistro
 Module gauche
 22 kg 1,02 m²



078005085

SEAT CUSHION + BACK CUSHIONS
 Sitzkissen + Rückenkissen
 Cojín de asiento + Cojines de respaldo
 Cuscino seduta + Cuscini schienale
 Coussin d'assise + Coussins de dossier
 130 × 65 cm + 231 × 55 cm

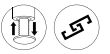

078005

95078005

56078005000



078005079

RIGHT MODULE

Modul rechts
 Módulo derecho
 Modulo destro
 Module droit
 22 kg 1,02 m²



078003085

SEAT CUSHION + BACK CUSHIONS
 Sitzkissen + Rückenkissen
 Cojín de asiento + Cojines de respaldo
 Cuscino seduta + Cuscini schienale
 Coussin d'assise + Coussins de dossier
 130 × 65 cm + 231 × 55 cm

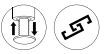

078003

95078003

56078003000



078003079

3-SEATER, INCL. LEFT + RIGHT ARMREST
 3er-Sofa, Armlehne links + rechts
 Sofá 3 plazas, incl. brazos izquierdo y derecho
 Divano 3 posti, bracciolo sinistro e destro
 Canapé 3 places, accoudoir gauche et droit incl.
 49 kg 1,8 m³



078013085

SEAT CUSHION + BACK CUSHIONS + 2x SIDE CUSHIONS
 Sitzkissen + Rückenkissen + 2x Seitenkissen
 Cojín de asiento + Cojines de respaldo + 2x Cojines lateral
 Cuscino seduta + Cuscini schienale + 2x Cuscini laterale
 Coussin d'assise + Coussins de dossier + 2x Coussins latéral
 208 x 65 cm + 241 x 55 cm + 2x 50 x 40 cm



078013

95078013

56078013000



078013079

DAYBED, INCL. LEFT ARMREST
 Daybed, Armlehne links
 Daybed, brazo izquierdo
 Daybed, bracciolo sinistro
 Daybed, accoudoir gauche incl.
 32 kg 1,23 m³



078018085

SEAT CUSHION + BACK CUSHION + SIDE CUSHION
 Sitzkissen + Rückenkissen + Seitenkissen
 Cojín de asiento + Cojín de respaldo + Cojín lateral
 Cuscino seduta + Cuscino schienale + Cuscino laterale
 Coussin d'assise + Coussin de dossier + Coussin latéral
 132 x 76 cm + 92 x 55 cm + 50 x 40 cm



078018

95078018

56078018000



078018079

DAYBED, INCL. RIGHT ARMREST
 Daybed, Armlehne rechts
 Daybed, incl. brazo derecho
 Daybed, bracciolo destro
 Daybed, accoudoir droit incl.
 32 kg 1,23 m³



078017085

SEAT CUSHION + BACK CUSHION + SIDE CUSHION
 Sitzkissen + Rückenkissen + Seitenkissen
 Cojín de asiento + Cojín de respaldo + Cojín lateral
 Cuscino seduta + Cuscino schienale + Cuscino laterale
 Coussin d'assise + Coussin de dossier + Coussin latéral
 132 x 76 cm + 92 x 55 cm + 50 x 40 cm



078017

95078017

56078017000



078017079

BEACH CHAIR *
 Sonnenliege
 Tumbona
 Lettino
 Chaise longue
 15 kg 0,37 m³



078019

078019085

CUSHION
 Kissen
 Cojín
 Cuscino
 Coussin
 75 x 187 cm

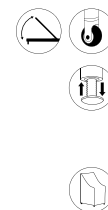

95078019

56078019000



078019079

FOOTSTOOL
 Hocker
 Reposapiés
 Pouf
 Repose-pieds
 11 kg 0,2 m³



078031085



078031079

SEAT CUSHION
 Sitzkissen
 Cojín de asiento
 Cuscino seduta
 Coussin d'assise
 88 x 88 cm



078031

95078031

56078031000

COFFEE TABLE
 Kaffeetisch
 Mesa de centro
 Tavolino da salotto
 Table de salon
 88 x 88 cm
 4 kg 0,2 m³



Set: 078036315

MINERAL-COMPOSITE BASALIT
 Mineralverbund basalt
 Compuesto mineral basalt
 Composito minerale basalt
 Composite minéral basalt
 22,5 kg

23378035315



Set: 078036316

MINERAL-COMPOSITE MOCCA
 Mineralverbund mocca
 Compuesto mineral mocca
 Composito minerale mocca
 Composite minéral mocca
 22,5 kg

23378035316



078035

56078036000

COFFEE TABLE
 Kaffeetisch
 Mesa de centro
 Tavolino da salotto
 Table de salon
 176 x 88 cm
 8 kg 0,39 m³



Set: 078038315

2x MINERAL-COMPOSITE BASALIT
 2x Mineralverbund basalt
 2x Compuesto mineral basalt
 2x Composito minerale basalt
 2x Composite minéral basalt
 2x 22,5 kg (Total 45 kg)

2x 23378035315

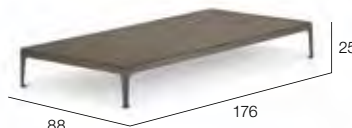

Set: 078038316

2x MINERAL-COMPOSITE MOCCA
 2x Mineralverbund mocca
 2x Compuesto mineral mocca
 2x Composito minerale mocca
 2x Composite minéral mocca
 2x 22,5 kg (Total 45 kg)

2x 23378035316

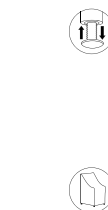

078037

56078038000

Tabletop mineral-composite



315 basalt



316 mocca

* EN This item is also available with hook-catching mechanism upon request.

DE Dieser Artikel ist auf Anfrage auch mit Stufenverstellung erhältlich.

ES Bajo pedido este artículo también está disponible con un mecanismo de ajuste escalonado.

IT Questo articolo è disponibile su richiesta anche con meccanismo di regolazione reclinabile.

FR Cet article est disponible, sur demande, avec un mécanisme de réglage du niveau d'inclinaison.

TRAY
Tablett
Bandeja
Vassoio
Plateau
78 x 29 cm
2 kg

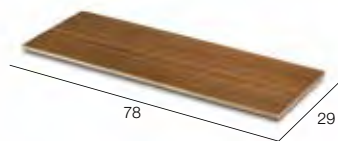

078099201

EN Multi-layered and of varying densities, the foam of the RAYN collection **cushions** gives them a suppleness comparable to that of down feathers and allows them quickly to recover their original shape. The comfort level of the cushions is truly extraordinary, rivaling that of luxury indoor cushions. The **coffee table** with basalit top combines nicely with RAYN furniture in salina. The coffee table with mocca top combines nicely with RAYN furniture in veneto. The RAYN **tray** features a teak finish. The entire tray is covered with an outdoor sealant to protect it from water and humidity. This material offers excellent protection against abrasion, UV rays and all weather conditions. Clean with a damp cloth. Do not apply cleaning detergent of any kind. To maintain the beautiful wood finish, the RAYN teak tray should be protected from moisture and kept indoors when not in use.

DE Der Schaumstoff der RAYN Kissen besteht aus mehreren Schichten unterschiedlicher Dichte. Die **Kissen** sind so weich, dass man sie durchaus mit daunenfedergefüllten Kissen vergleichen kann. Eine weitere Eigenschaft ist, dass sie schnell wieder in ihre ursprüngliche Form zurückfinden. Die Kissen sind außerordentlich gemütlich und können es ohne Weiteres mit Luxuskissen für den Innenbereich aufnehmen. Die **Kaffeetische** mit basalitfarbener Tischplatte lassen sich hervorragend mit den RAYN Modulen in salina kombinieren. Die Kaffeetische mit mocca-farbener Tischplatte lassen sich sehr gut mit den RAYN Modulen in veneto kombinieren. Das RAYN **Tablett** besteht aus schichtverleimtem Holz sowie einer aus Teakholz gefertigten Oberfläche. Das Tablett ist durch ein Versiegelungsmittel gegen Wasser und Feuchtigkeit geschützt. Dieses Verfahren bietet exzellenten Schutz gegen Abrieb, UV-Strahlung und ist zudem äußerst wetterbeständig. Einfach mit einem weichen Tuch und warmem Wasser reinigen – ohne Anwendung weiterer Reinigungsmittel. Die Oberfläche des RAYN Tablett besteht aus einem Holzdekor und sollte vor Feuchtigkeit geschützt werden. Wir empfehlen daher die Aufbewahrung in Innenräumen.

ES De varias capas y densidades variables, la espuma de los **cojines** de la colección RAYN les da una flexibilidad comparable a las del plumón y les permite rápidamente recuperar su forma original. El nivel de confort de los cojines es verdaderamente extraordinario, comparable con los cojines de lujo de interior. Las **mesas de centro** con tablero de color basalit se pueden combinar perfectamente con los módulos RAYN en color salina. La mesa de centro con tablero en mocca combina perfectamente con el mobiliario RAYN de color veneto. La **bandeja** RAYN está fabricada en contrachapado de teca. La bandeja está recubierta con un material sellador especial para exteriores que la protege tanto del agua como de la humedad. Este material ofrece un excelente nivel de protección contra el roce, los rayos UV y todo tipo de condiciones climatológicas. Límpiela con un paño húmedo y no aplique ningún tipo de limpiador detergente. Para mantener el acabado de la teca, recomendamos que proteja la bandeja de la humedad y que se mantenga en el interior cuando no esté en uso.

IT La schiuma dei **cuscini** della collezione RAYN, multistrato e di densità variabile, offre una morbidezza paragonabile a quella della piuma d'oca e permette loro di recuperare rapidamente la forma originale. Il livello di comfort di questi cuscini è davvero straordinario, sicuramente all'altezza di quello dei cuscini da interno più lussuosi. Il **tavolino da salotto** con il piano color Basalit si combina perfettamente con i moduli RAYN Salina. Il tavolino da salotto con il piano Mocca si abbina perfettamente agli arredi RAYN Veneto. Il **vassoio** RAYN è interamente rivestito in Teak e sottoposto ad una finitura speciale per esterni con uno speciale sigillante che assicura la massima protezione da acqua e umidità. Questo materiale offre un'eccellente protezione contro le abrasioni, i raggi UV e tutti gli agenti atmosferici. Per mantenere inalterata la bellezza delle finiture in legno, il vassoio RAYN deve essere protetto dall'umidità e tenuto all'interno quando non viene utilizzato.

FR Multicouche et de densité variable, la mousse de la collection RAYN donne aux **coussins** une souplesse égale à celle du duvet et leur permet de retrouver leur forme initiale en très peu de temps. Les coussins présentent un niveau de confort extraordinaire, rivalisant avec celui des coussins d'intérieur de luxe. La **table de salon** avec le dessus de table Basalit est parfaitement assortie aux meubles RAYN Salina. La table de salon avec le dessus de table Mocca est parfaitement assortie aux meubles RAYN Veneto. Le plateau RAYN est en contre-plaqué de jonc à finition en teck. Le **plateau** est entièrement recouvert d'un enduit imperméable pour l'extérieur, assurant ainsi une protection contre l'eau et l'humidité. La matière offre une excellente protection contre l'abrasion, les rayons UV et toutes les conditions climatiques. Nettoyer avec un chiffon humide. Ne pas utiliser de détergent d'aucune sorte. Afin de préserver la beauté du bois du plateau RAYN, il est recommandé de le maintenir à l'abri de l'humidité et de le conserver à l'intérieur lorsqu'il n'est pas utilisé.

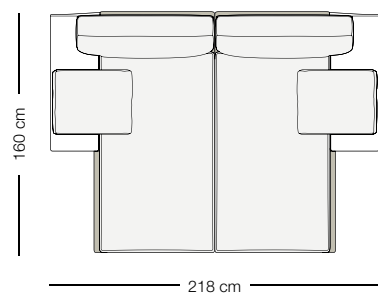

RAYN Setting 01

- 1x **078017** – Daybed incl. right armrest, seat cushion + back cushion + side cushion
- 1x **078018** – Daybed incl. left armrest, seat cushion + back cushion + side cushion

Recommended deco cushions:
2x 95050081 – 40 × 40 cm

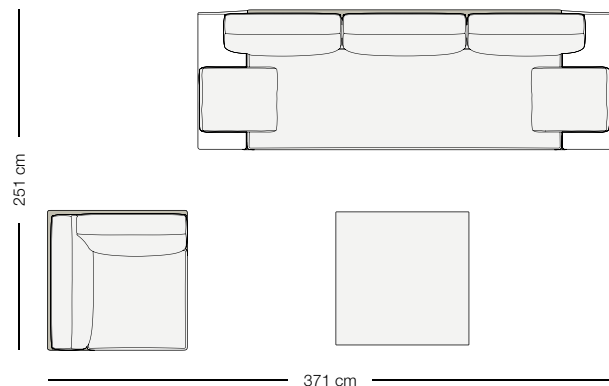

RAYN Setting 02

- 1x **078006** – Corner module + seat cushion + back cushions (left)
- 1x **078013** – 3-seater incl. left + right armrest, seat cushion + back cushions + 2x side cushion
- 1x **078036** – Coffee table 88 × 88 cm, mineral-composite top

Recommended deco cushions:
2x 95050081 – 40 × 40 cm
1x 95050082 – 50 × 50 cm

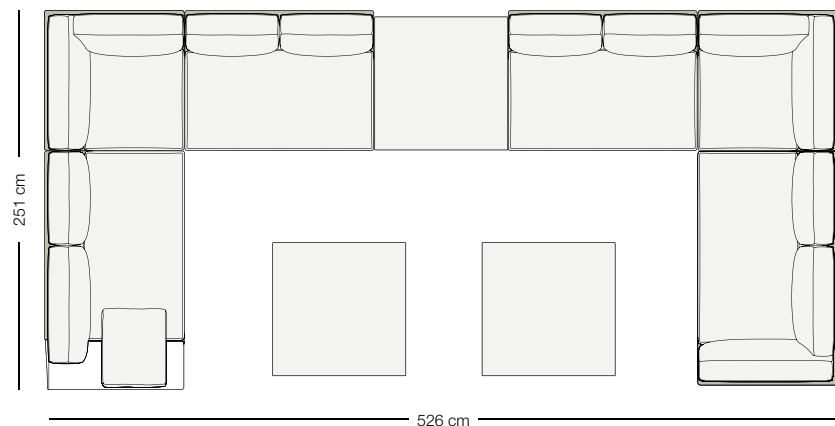

RAYN Setting 03

- 1x **078009** – Right module incl. right armrest, seat cushion + back cushions + side cushion
- 2x **078006** – Corner module, seat cushion + back cushions
- 2x **078007** – Center module, seat cushion + back cushions
- 1x **078005** – Left module, seat cushion + back cushions
- 3x **078031** – Footstool 88 × 88 cm, seat cushion

Recommended deco cushions:
6x 95050081 – 40 × 40 cm
4x 95050082 – 50 × 50 cm

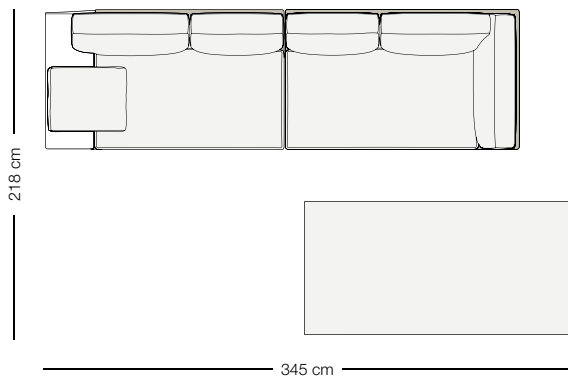

RAYN Setting 04

- 1x 078009** – Right module incl. right armrest, seat cushion + back cushions + side cushion
- 1x 078005** – Left module, seat cushion + back cushions
- 1x 078038** – Coffee table 176 x 88 cm, 2x mineral composite top

Recommended deco cushions:

- 2x 95050081** – 40 x 40 cm
- 1x 95050082** – 50 x 50 cm

For inspiration please see page 110

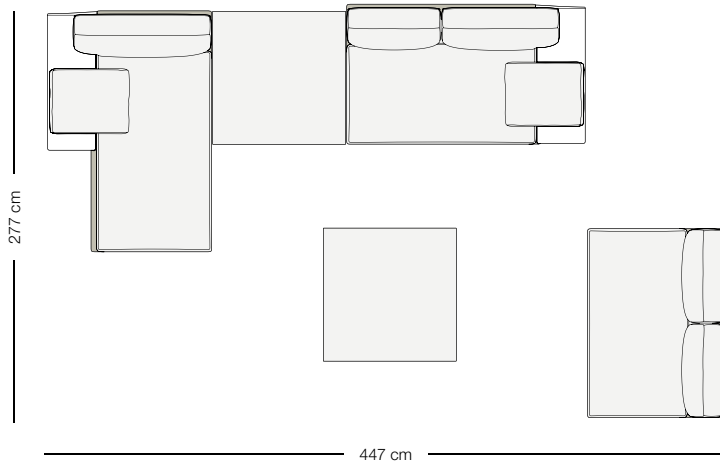

RAYN Setting 05

- 1x 078017** – Daybed incl. right armrest, seat cushion + back cushion + side cushion
- 1x 078031** – Footstool 88 x 88 cm, seat cushion
- 1x 078008** – Left module incl. left armrest, seat cushion + back cushions + side cushion
- 1x 078036** – Coffee table 88 x 88 cm, mineral-composite top
- 1x 078007** – Center module, seat cushion + back cushions

Recommended deco cushions:

- 3x 95050081** – 40 x 40 cm
- 2x 95050082** – 50 x 50 cm

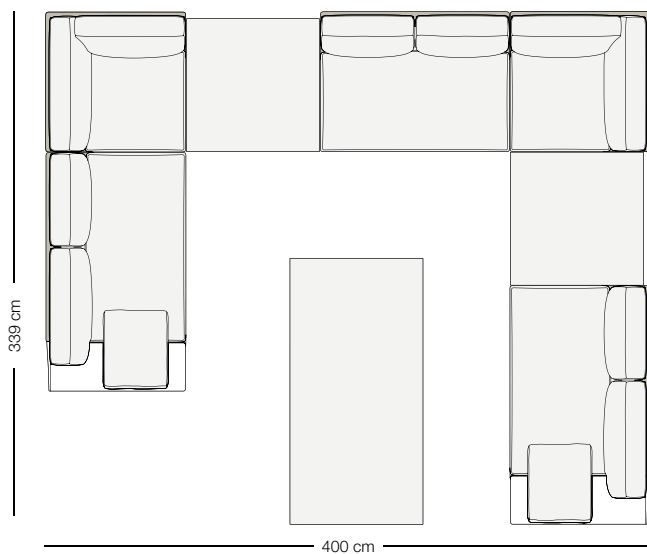

RAYN Setting 06

- 1x 078009** – Right module incl. right armrest, seat cushion + back cushions + side cushion
- 2x 078006** – Corner module, seat cushion + back cushions
- 2x 078031** – Footstool 88 x 88 cm, seat cushion
- 1x 078007** – Center module, seat cushion + back cushions
- 1x 078008** – Left module incl. left armrest, seat cushion + back cushions + side cushion
- 1x 078038** – Coffee table 176 x 88 cm, 2x mineral composite top

Recommended deco cushions:

- 5x 95050081** – 40 x 40 cm
- 3x 95050082** – 50 x 50 cm



Recommended combinations

Rope	Powder coating	Recommended fabrics		
NEW		+		
155	317	452	661	675
taupe melange	black pepper	COOL taupe Cat. A	TWIST sand Cat. B	Kvadrat patio220 Cat. B

Rope	Powder coating	Recommended fabrics		
NEW		+	NEW	
156	317	458	684	681
teal melange	black pepper	COOL ash Cat. A	MAR nori Cat. B	Kvadrat patio970 Cat. B

Fiber	Powder coating	Recommended fabrics		
NEW		+		
157	317	452	660	675
taupe touch	black pepper	COOL taupe Cat. A	TWIST beige Cat. B	Kvadrat patio220 Cat. B

Fiber	Powder coating	Recommended fabrics		
NEW		+	NEW	
158	317	458	684	681
teal touch	black pepper	COOL ash Cat. A	MAR nori Cat. B	Kvadrat patio970 Cat. B

Fiber for Cocoon chair and footstool only

Fiber	Powder coating	Recommended fabrics		
NEW		+		
159	317	458	660	680
rosewood touch	black pepper	COOL ash Cat. A	TWIST beige Cat. B	Kvadrat patio370 Cat. B

Fiber	Powder coating	Recommended fabrics		
NEW		+	NEW	
160	317	458	682	681
saffron touch	black pepper	COOL ash Cat. A	MAR beech Cat. B	Kvadrat patio970 Cat. B

ARMCHAIR
 Armlehnstuhl
 Silla con brazos
 Poltrona pranzo
 Fauteuil repas
 5,9 kg 0,26 m³



103001155



103001156

SEAT CUSHION
 Sitzkissen
 Cojín de asiento
 Cuscino seduta
 Coussin d'assise

OPTIONAL BACK CUSHION
 Optionales Rückenkissen
 Cojín de respaldo opcional
 Cuscino schienale opzionale
 Coussin de dossier en option
 40 x 40 cm



103001

95103001

95103002

56103001000



103001157



103001158

DRY+ SEAT CUSHION
 Dry+ Sitzkissen
 Dry+ Cojín de asiento
 Dry+ Cuscino seduta
 Dry+ Coussin d'assise

DRY+ OPTIONAL BACK CUSHION
 Dry+ optionales Rückenkissen
 Dry+ cojín de respaldo opcional
 Dry+ cuscino schienale opzionale
 Dry+ coussin de dossier en option
 40 x 40 cm



95103201

95103202

Complementary tables



TIBBO dining table



MBRACE dining table



AIIIR dining table

2-SEATER
 2er-Sofa
 Sofá 2 plazas
 Divano 2 posti
 Canapé 2 places
 15,7 kg 1,14 m³



103012155



103012156

CUSHION SET
 Kissenset
 Set de cojines
 Set di cuscini
 Set de coussins



103012

95103012

56103012000



103012157



103012158

DRY+ CUSHION SET
 Dry+ Kissenset
 Dry+ Set de cojines
 Dry+ Set di cuscini
 Dry+ Set de coussins



95103212

3-SEATER
 3er-Sofa
 Sofá 3 plazas
 Divano 3 posti
 Canapé 3
 21,4 kg 1,57 m³



103015155



103015156

CUSHION SET
 Kissenset
 Set de cojines
 Set di cuscini
 Set de coussins



103015

95103015

56103015000



103015157



103015158

DRY+ CUSHION SET
 Dry+ Kissenset
 Dry+ Set de cojines
 Dry+ Set di cuscini
 Dry+ Set de coussins



95103215

LOUNGE CHAIR

Sessel
Sillón bajo
Poltrona club
Fauteuil club
9,3 kg 0,64 m³



103005155

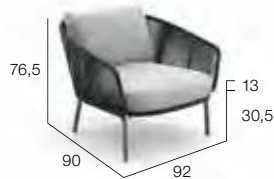

103005156



103005157



103005158

CUSHION SET
Kissenset
Set de cojines
Set di cuscini
Set de coussins



103005

95103005

56103005000

DRY+ CUSHION SET
Dry+ Kissenset
Dry+ Set de cojines
Dry+ Set di cuscini
Dry+ Set de coussins



COCOON CHAIR

Cocoon Sessel
Sillón bajo Cocoon
Poltrona Cocoon
Fauteuil club Cocoon
17,5 kg 1,37 m³



103008155



103008156



103008157



103008158



103008159



103008160

CUSHION SET
Kissenset
Set de cojines
Set di cuscini
Set de coussins



103008

95103005

56103008000

DRY+ CUSHION SET
Dry+ Kissenset
Dry+ Set de cojines
Dry+ Set di cuscini
Dry+ Set de coussins



FOOTSTOOL

Hocker
Taburete
Pouf
Repose-pieds
4,7 kg 0,13 m³



103032155

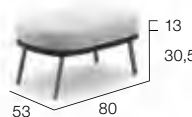

103032156



103032157



103032158

SEAT CUSHION
Sitzkissen
Cojín de asiento
Cuscino seduta
Coussin d'assise



103032

95103032

56103032000

DRY+ SEAT CUSHION
Dry+ Sitzkissen
Dry+ Cojín de asiento
Dry+ Cuscino seduta
Dry+ Coussin d'assise



FOOTSTOOL

Hocker
Taburete
Pouf
Repose-pieds



103032159



103032160

56103032000



DAYBED LEFT

Daybed links
Daybed izquierdo
Daybed sinistro
Daybed gauche
13,9 kg 1,07 m³



103020155

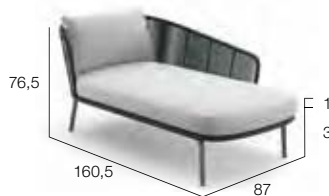

103020156

CUSHION SET
Kissenset
Set de cojines
Set di cuscini
Set de coussins



103020

95103020

56103020000

DRY+ CUSHION SET
Dry+ Kissenset
Dry+ Set de cojines
Dry+ Set di cuscini
Dry+ Set de coussins



103020157



103020158

95103220

DAYBED RIGHT

Daybed rechts
Daybed derecho
Daybed destro
Daybed droit
13,9 kg 1,07 m³



103022155

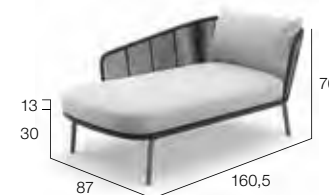

103022156

CUSHION SET
Kissenset
Set de cojines
Set di cuscini
Set de coussins



103022

95103022

56103022000

DRY+ CUSHION SET
Dry+ Kissenset
Dry+ Set de cojines
Dry+ Set di cuscini
Dry+ Set de coussins



103022157



103022158

95103222

RECOMMENDED DECO CUSHIONS

Empfohlene Dekokissen
Cojines decoración recomendados
Cuscini decorativi consigliati
Coussins déco recommandés

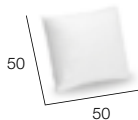

95050082

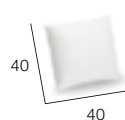

95050081

ADDITIONAL WHEELS FOR DOUBLE DAYBEDS, DAYBED LEFT AND DAYBED RIGHT

Zusätzliche Rollen für Doppel-Daybeds, Daybed links und Daybed rechts
Ruedas adicionales para daybeds dobles, daybeds izquierdos y daybeds derechos
Ruote supplementari per daybed matrimoniali, daybed sinistro e daybed destro
Roulettes supplémentaires pour daybed double, daybed gauche et daybed droit



103079000

DOUBLE DAYBED
Doppel-Daybed
Daybed doble
Daybed matrimoniale
Daybed double
35,2 kg 2,8 m³



103018155



103018156



103018157



103018158

CUSHION SET
Kissenset
Set de cojines
Set di cuscini
Set de coussins

ADDITIONAL BACK CUSHION
Zusätzliches Rückenkissen
Cojín de respaldo adicional
Cuscino schienale supplementare
Coussin de dossier supplémentaire



103018

95103018

2x 95103019

56103018000

DRY+ CUSHION SET
Dry+ Kissenset
Dry+ Set de cojines
Dry+ Set di cuscini
Dry+ Set de coussins

DRY+ ADDITIONAL BACK CUSHION
Dry+ zusätzliches Rückenkissen
Dry+ cojín de respaldo adicional
Dry+ cuscino schienale supplementare
Dry+ coussin de dossier supplémentaire



COCOON DOUBLE DAYBED
Cocoon Doppel-Daybed
Daybed doble Cocoon
Daybed matrimoniale Cocoon
Double daybed Cocoon
42,7 kg 5,4m³



103019155

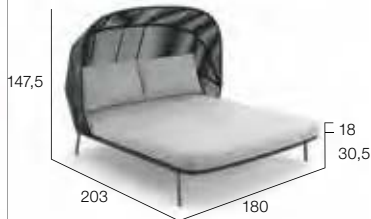

103019156



103019157



103019158

CUSHION SET
Kissenset
Set de cojines
Set di cuscini
Set de coussins

ADDITIONAL BACK CUSHION
Zusätzliches Rückenkissen
Cojín de respaldo adicional
Cuscino schienale supplementare
Coussin de dossier supplémentaire



103019

95103018

2x 95103019

56103019000

DRY+ CUSHION SET
Dry+ Kissenset
Dry+ Set de cojines
Dry+ Set di cuscini
Dry+ Set de coussins

DRY+ ADDITIONAL BACK CUSHION
Dry+ zusätzliches Rückenkissen
Dry+ cojín de respaldo adicional
Dry+ cuscino schienale supplementare
Dry+ coussin de dossier supplémentaire

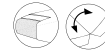

EN RILLY comes in a choice of DEDON Fiber or maritime rope. DEDON Fiber taupe touch, teal touch, saffron touch and rosewood touch is characterized by its extraordinary soft touch, matte look, great strength, UV-resistance and ability to withstand even the harshest weather conditions. The rope, which is made of polypropylene, which has a textile touch and excellent tensile strength, is also weatherproof, UV-resistant and light-fast.

DE RILLY ist in zwei Ausführungen erhältlich: Aus DEDON-Faser oder einem maritimen Seilmaterial. Die DEDON-Faser in den Farben Taupe Touch, Teal Touch, Saffron Touch und Rosewood Touch besticht durch ihre ungewöhnlich weiche Haptik, den matten Look, ihre Robustheit und UV-Beständigkeit sowie ihre Fähigkeit, selbst den härtesten Bedingungen zu trotzen. Das Polypropylen-Seil mit textilem Touch ist hochreißfest und ebenfalls wetterbeständig, UV-beständig und lichtecht.

ES RILLY está disponible en diferentes fibras DEDON o cuerda náutica. Las fibras DEDON en los colores taupe touch, teal touch, saffron touch y rosewood touch se caracterizan por su extraordinario tacto suave, aspecto mate, increíble durabilidad, resistencia a los rayos UVA y capacidad de soportar incluso las condiciones climáticas más adversas. La cuerda, elaborada con polipropileno, tiene un tacto parecido al de un tejido y una excelente fuerza de tensión. También es impermeable y resistente a los rayos UVA y a la luz.

IT RILLY si presenta nelle varianti in Fibra DEDON o corda nautica. La Fibra DEDON nelle nuance taupe, tè blu, zafferano e palissandro, è caratterizzata da straordinaria morbidezza al tatto, aspetto opaco, grande robustezza, resistenza ai raggi UV e capacità di sostenere persino le condizioni atmosferiche più avverse. La corda realizzata in polipropilene ha una mano tessile e un'eccellente resistenza alla trazione, essa è inoltre impermeabile, resistente ai raggi UV e alla luce.

FR RILLY est disponible au choix en fibre DEDON ou en corde maritime. La fibre DEDON en nuances taupe, bleu sarcelle, safran et bois de rose est caractérisée par un toucher remarquablement doux, un aspect mat, une grande robustesse, une résistance aux UV et par la capacité de résister même aux conditions climatiques les plus rigoureuses. La corde en polypropylène, au toucher textile et dotée d'une excellente résistance à la traction, est également résistante aux intempéries, aux UV et à la lumière.



Cocoon double daybed, teal melange
Cushion: Kvadrat patio970

SATELLITE

Design by JEAN-MARIE MASSAUD



Powder coating

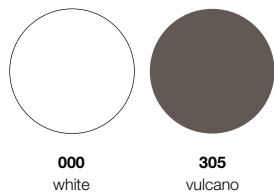

DINING TABLE

Esstisch
Mesa comedor
Tavolo pranzo
Table repas
ø 70 cm
40,5 kg 0,36 m³



050140000



050140305



1+1



56050040000

SIDE TABLE

Beistelltisch
Mesa auxiliar
Tavolino ausiliare
Table d'appoint
ø 40 cm
5,8 kg 0,07 m³



050133000



050133305

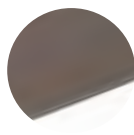

56050033000

Tabletops HPL

000 white

305 vulcano

EN Tabletop: "High Pressure Laminate" (HPL) – A non-toxic material that is highly resistant to impact, mechanical stress, moisture and steam. To clean a HPL tabletop, use a soft cloth, warm water and a gentle cleanser if needed. Base: powder coated aluminum.

DE Tischplatte: „High Pressure Laminate“ (HPL) ist ein ungiftiges Material, das sich durch hohe Stoßfestigkeit und extreme Widerstandskraft gegen mechanische Einwirkungen, Feuchtigkeit und Dampf auszeichnet. Zur Reinigung der Tischplatte eignen sich ein weiches Tuch, warmes Wasser und bei Bedarf ein sanftes Reinigungsmittel. Fuß: Hergestellt aus pulverbeschichtetem Aluminium.













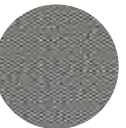

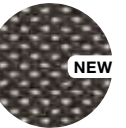

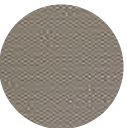
ES Tablero de mesa: HPL – El laminado de alta presión es un material no tóxico altamente resistente al impacto, estrés mecánico, humedad y vapor. Para limpiar los tableros de las mesas, utilice un paño suave y agua caliente y, si es necesario, un limpiador suave. Base: Fabricado en aluminio con revestimiento de pintura en polvo.

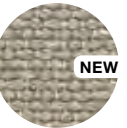
IT Piano del tavolo: HPL – Il laminato ad alta pressione (HPL) è un materiale non tossico estremamente resistente agli impatti, alle sollecitazioni meccaniche, all'umidità e al vapore. Per pulire i piani usare un panno soffice, acqua calda e, se necessario, un detergente delicato. Base: Fabbricato in alluminio rivestiti in polvere.

FR Plateau: HPL – Le stratifié HPL (High Press Laminate) est un matériau non toxique, hautement résistant aux impacts, aux contraintes mécaniques, à l'humidité et à la vapeur d'eau. Pour nettoyer le plateau de table, utilisez un chiffon doux et de l'eau chaude et, si nécessaire, un détergent léger. Pied: Conçu en aluminium thermolaqué.

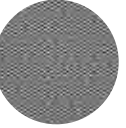
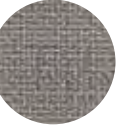
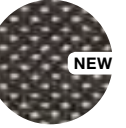

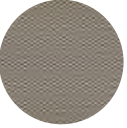
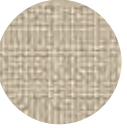
Recommended combinations

Fiber		Powder coating	Recommended fabrics			Fiber		Powder coating	Recommended fabrics		
											
211 titan	154 silver beige	317 black pepper	458 COOL ash Cat. A	683 MAR ash Cat. B	707 GLAN shale Cat. C	153 pristine	304 lipari	452 COOL taupe Cat. A	683 MAR ash Cat. B	706 GLAN drift Cat. C	
Rope		Powder coating	Recommended fabrics			Rope		Powder coating	Recommended fabrics		
											
152 slate	153 pristine	317 black pepper	458 COOL ash Cat. A	652 LINEN warm gray Cat. B	707 GLAN shale Cat. C	153 pristine	304 lipari	452 COOL taupe Cat. A	651 LINEN sand Cat. B	706 GLAN drift Cat. C	

2-SEATER
2er-Sofa
Sofá 2 plazas
Divano 2 posti
Canapé 2 places
Rope: 44,4 kg 1,6 m³
Fiber: 39,5 kg 1,6 m³



CUSHION SET
Kissenset
Set de cojines
Set di cuscini
Set de coussins

ADDITIONAL BACK CUSHION
Zusätzliches Rückenkissen
Cojín de respaldo adicional
Cuscino schienale supplementare
Coussin de dossier supplémentaire
85 x 51 x 15 cm



105012

105012153

105012152

95105012

2x 95105097

56105012000



DRY+ CUSHION SET
Dry+ Kissenset
Dry+ Set de cojines
Dry+ Set di cuscini
Dry+ Set de coussins

DRY+ ADDITIONAL BACK CUSHION
Dry+ zusätzliches Rückenkissen
Dry+ cojín de respaldo adicional
Dry+ cuscino schienale supplementare
Dry+ coussin de dossier supplémentaire
85 x 51 x 15 cm



105012154

105012211

95105212

2x 95105297

LEFT MODULE
Modul links
Módulo izquierdo
Modulo sinistro
Module gauche
Rope: 40,2 kg 1,56 m³
Fiber: 36 kg 1,56 m³



CUSHION SET
Kissenset
Set de cojines
Set di cuscini
Set de coussins

ADDITIONAL BACK CUSHION
Zusätzliches Rückenkissen
Cojín de respaldo adicional
Cuscino schienale supplementare
Coussin de dossier supplémentaire
85 x 51 x 15 cm



105005

105005153

105005152

95105003

2x 95105097

56105005000



DRY+ CUSHION SET
Dry+ Kissenset
Dry+ Set de cojines
Dry+ Set di cuscini
Dry+ Set de coussins

DRY+ ADDITIONAL BACK CUSHION
Dry+ zusätzliches Rückenkissen
Dry+ cojín de respaldo adicional
Dry+ cuscino schienale supplementare
Dry+ coussin de dossier supplémentaire
85 x 51 x 15 cm



105005154

105005211

95105203

2x 95105297

RIGHT MODULE
Modul rechts
Módulo derecho
Modulo destro
Module droit
Rope: 40,2 kg 1,56 m³
Fiber: 36 kg 1,56 m³



CUSHION SET
Kissenset
Set de cojines
Set di cuscini
Set de coussins

ADDITIONAL BACK CUSHION
Zusätzliches Rückenkissen
Cojín de respaldo adicional
Cuscino schienale supplementare
Coussin de dossier supplémentaire
85 x 51 x 15 cm



105003

105003153

105003152

95105003

2x 95105097

56105003000



DRY+ CUSHION SET
Dry+ Kissenset
Dry+ Set de cojines
Dry+ Set di cuscini
Dry+ Set de coussins

DRY+ ADDITIONAL BACK CUSHION
Dry+ zusätzliches Rückenkissen
Dry+ cojín de respaldo adicional
Dry+ cuscino schienale supplementare
Dry+ coussin de dossier supplémentaire
85 x 51 x 15 cm



105003154

105003211

95105203

2x 95105297

RECOMMENDED DECO CUSHIONS
Empfohlene Dekokissen
Cojines decoración recomendados
Cuscini decorativi consigliati
Coussins déco recommandés

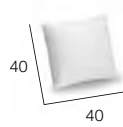
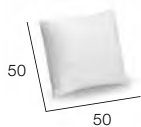

95050082

95050081

3-SEATER
3er-Sofa
Sofá 3 plazas
Divano 3 posti
Canapé 3 places
Rope: 55,6 kg 2,3 m³
Fiber: 49 kg 2,3 m³

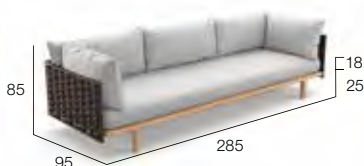

CUSHION SET
Kissenset
Set de cojines
Set di cuscini
Set de coussins

ADDITIONAL BACK CUSHION
Zusätzliches Rückenkissen
Cojín de respaldo adicional
Cuscino schienale supplementare
Coussin de dossier supplémentaire
85 x 51 x 15 cm



105015

105015153

105015152



105015154



105015211

95105015

DRY+ CUSHION SET
Dry+ Kissenset
Dry+ Set de cojines
Dry+ Set di cuscini
Dry+ Set de coussins

3x 95105097

DRY+ ADDITIONAL BACK CUSHION
Dry+ zusätzliches Rückenkissen
Dry+ cojín de respaldo adicional
Dry+ cuscino schienale supplementare
Dry+ coussin de dossier supplémentaire
85 x 51 x 15 cm



LEFT MODULE XL
Modul links XL
Módulo izquierdo XL
Modulo sinistro XL
Module gauche XL
Rope: 50 kg 2,27 m³
Fiber: 45 kg 2,27 m³

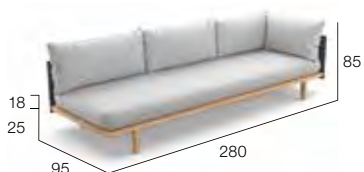

CUSHION SET
Kissenset
Set de cojines
Set di cuscini
Set de coussins

ADDITIONAL BACK CUSHION
Zusätzliches Rückenkissen
Cojín de respaldo adicional
Cuscino schienale supplementare
Coussin de dossier supplémentaire
85 x 51 x 15 cm



105006

105006153

105006152



105006154



105006211

95105004

DRY+ CUSHION SET
Dry+ Kissenset
Dry+ Set de cojines
Dry+ Set di cuscini
Dry+ Set de coussins

3x 95105097

DRY+ ADDITIONAL BACK CUSHION
Dry+ zusätzliches Rückenkissen
Dry+ cojín de respaldo adicional
Dry+ cuscino schienale supplementare
Dry+ coussin de dossier supplémentaire
85 x 51 x 15 cm



RIGHT MODULE XL
Modul rechts XL
Módulo derecho XL
Modulo destro XL
Module droit XL
Rope: 50 kg 2,27 m³
Fiber: 45 kg 2,27 m³

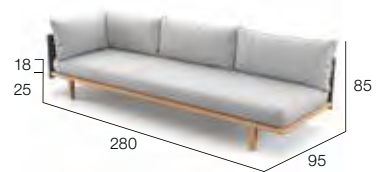

CUSHION SET
Kissenset
Set de cojines
Set di cuscini
Set de coussins

ADDITIONAL BACK CUSHION
Zusätzliches Rückenkissen
Cojín de respaldo adicional
Cuscino schienale supplementare
Coussin de dossier supplémentaire
85 x 51 x 15 cm



105004

105004153

105004152



105004154



105004211

95105004

DRY+ CUSHION SET
Dry+ Kissenset
Dry+ Set de cojines
Dry+ Set di cuscini
Dry+ Set de coussins

3x 95105097

DRY+ ADDITIONAL BACK CUSHION
Dry+ zusätzliches Rückenkissen
Dry+ cojín de respaldo adicional
Dry+ cuscino schienale supplementare
Dry+ coussin de dossier supplémentaire
85 x 51 x 15 cm



EXTENDED DAYBED LEFT
 Verlängertes Daybed links
 Daybed izquierdo alargado
 Daybed sinistro allungato
 Daybed gauche rallongé
 Rope: 45,2 kg 2,27 m³
 Fiber: 41 kg 2,27 m³



CUSHION SET
 Kissenset
 Set de cojines
 Set di cuscini
 Set de coussins

ADDITIONAL BACK CUSHION
 Zusätzliches Rückenkissen
 Cojín de respaldo adicional
 Cuscino schienale supplementare
 Coussin de dossier supplémentaire
 85 × 51 × 15 cm



105017

105017153

105017152

95105017

2x 95105097

56105017000



DRY+ CUSHION SET
 Dry+ Kissenset
 Dry+ Set de cojines
 Dry+ Set di cuscini
 Dry+ Set de coussins

DRY+ ADDITIONAL BACK CUSHION
 Dry+ zusätzliches Rückenkissen
 Dry+ cojín de respaldo adicional
 Dry+ cuscino schienale supplementare
 Dry+ coussin de dossier supplémentaire
 85 × 51 × 15 cm



105017154

105017211

95105217

2x 95105297

EXTENDED DAYBED RIGHT
 Verlängertes Daybed rechts
 Daybed derecho alargado
 Daybed destro allungato
 Daybed droit allongé
 Rope: 45,2 kg 2,27 m³
 Fiber: 41 kg 2,27 m³



CUSHION SET
 Kissenset
 Set de cojines
 Set di cuscini
 Set de coussins

ADDITIONAL BACK CUSHION
 Zusätzliches Rückenkissen
 Cojín de respaldo adicional
 Cuscino schienale supplementare
 Coussin de dossier supplémentaire
 85 × 51 × 15 cm



105018

105018153

105018152

95105017

2x 95105097

56105018000



DRY+ CUSHION SET
 Dry+ Kissenset
 Dry+ Set de cojines
 Dry+ Set di cuscini
 Dry+ Set de coussins

DRY+ ADDITIONAL BACK CUSHION
 Dry+ zusätzliches Rückenkissen
 Dry+ cojín de respaldo adicional
 Dry+ cuscino schienale supplementare
 Dry+ coussin de dossier supplémentaire
 85 × 51 × 15 cm



105018154

105018211

95105217

2x 95105297

COFFEE TABLE
 Kaffeetisch
 Mesa de centro
 Tavolino da salotto
 Table de salon
 162 × 65 cm
 36,5 kg 0,28 m³

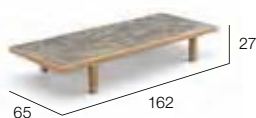

95105217

2x 95105297



105037

Set: 105037318

Set: 105037319

56105037000

COFFEE TABLE
 Kaffeetisch
 Mesa de centro
 Tavolino da salotto
 Table de salon
 90 × 90 cm
 24 kg 0,21 m³

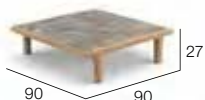

95105217

2x 95105297



105033

Set: 105033318

Set: 105033319

56105033000

Tabletop mineral-composite



NEW

318
 white marmi



NEW

319
 gray stone

COFFEE TABLE

Kaffeetisch
 Mesa de centro
 Tavolino da salotto
 Table de salon
69 x 174 cm
 32,5 kg 0,35 m³



105035205

56105035000

**BENCH**

Bank
 Banco
 Panca
 Banc
 10 kg 0,1 m³



105011205

56105011000



EN SEALINE comes in a choice of DEDON Fiber or maritime rope. The rope, which is made of polypropylene, has a textile touch and excellent tensile strength. It is also weatherproof, UV-resistant and light-fast.
 The backrests of the left and right modules and left and right modules XL can be flipped and used on the opposite sides.
 The solid teak coffee table and bench are made of premium teak. Wash using warm water in which natural soap flakes have been dissolved. The tabletops of coffee tables with teak frame come in a mineral composite with a printed marble pattern on top. The tabletop material is scratch-resistant, pore-free and highly resistant to frost, UV-rays and scuffing.

DE SEALINE ist in zwei Ausführungen erhältlich: Aus DEDON-Faser oder einem maritimen Seilmaterial. Das Polypropylen-Seil mit textilem Touch ist hochreißfest, wetterbeständig, UV-beständig und lichtecht.
 Die Rückenlehnen der linken und rechten XL-Module können auf die jeweils andere Seite umgelegt werden.
 Der Couchtisch und die Bank aus Vollholz sind aus Premium-Teakholz gefertigt. Zur Reinigung bitte warmes Wasser verwenden, in dem natürliche Seifenflocken vollständig aufgelöst wurden. Die Tischplatten der Couchtische mit Teakrahmen bestehen aus einem mineralischen Kompositmaterial mit aufgedrucktem Marmormuster auf der Oberseite. Das Material ist kratzfest, porenfrei und hochwiderstandsfähig gegen Frost, UV-Strahlung und Schrammen.

ES SEALINE está disponible en diferentes fibras DEDON o cuerda náutica. La cuerda, elaborada con polipropileno, tiene un tacto parecido al de un tejido y una excelente fuerza de tensión. También es impermeable y resistente a los rayos UVA y a la luz.
 Los respaldos de los módulos derechos e izquierdos y de los módulos XL derechos e izquierdos pueden voltearse y usarse por el lado opuesto.
 La mesa de centro y el banco de madera maciza están elaborados con teca de primera calidad. Limpiar con agua tibia una vez disueltas las virutas de jabón natural. Los tableros de las mesas de centro con estructura de teca están hechos a partir de un compuesto mineral que presenta un estampado de diseño amarmolado. El material con el que se fabrican los tableros es resistente a los rasguños, no tiene poros y es altamente resistente a las heladas, los rayos UVA y a las rozaduras.

IT SEALINE si presenta nelle varianti in Fibra DEDON o corda nautica. La corda realizzata in polipropilene ha una mano tessile ed un'eccellente resistenza alla trazione. Essa è anche impermeabile e resistente ai raggi UV e alla luce.
 Gli schienali dei moduli sinistro e destro e sinistro e destro XL possono essere capovolti e utilizzati sui lati opposti.
 Il tavolino e la panca in teak massiccio sono realizzati in pregiato teak. È consigliato pulire il teak con acqua calda in cui sono state dissolte scaglie di sapone naturale. I piani dei tavolini con telaio in teak sono in composito minerale con un disegno in marmo stampato sulla superficie. Il materiale del piano è antigraffio, non poroso e altamente resistente a gelo, raggi UV e scalfitture.

FR SEALINE vous attend dans un choix de fibre DEDON ou de corde maritime. La corde en polypropylène, au toucher textile et dotée d'une excellente résistance à la traction, est également résistante aux intempéries, aux UV et à la lumière.
 Les dossiers des modules gauche et droite et des modules XL droite et droit peuvent être inversés et utilisés du côté opposé.
 La solide table de salon et le banc sont en teck de haute qualité. Nettoyer avec un chiffon doux et de l'eau chaude dans laquelle des copeaux de savon naturel ont été dissous. Les plateaux des tables de salon au cadre en teck sont disponibles en matériau composite minéral avec des motifs de marbre imprimés sur leurs surfaces. La matériau du plateau de table est exempt de pores, résistant aux rayures, au gel, aux rayons UV et aux éraflures.

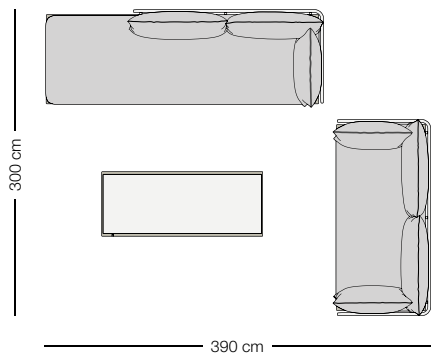

SEALINE Setting 01

- 1x **105018** – Extended daybed right, Dry+ cushion set
- 1x **105012** – 2-Seater, Dry+ cushion set
- 4x **95105297** – Dry+ additional back cushion
- 1x **105037** – Coffee table 65 x 162 cm

Recommended deco cushions:

- 2x **95050081** – 40 x 40 cm
- 1x **95050082** – 50 x 50 cm

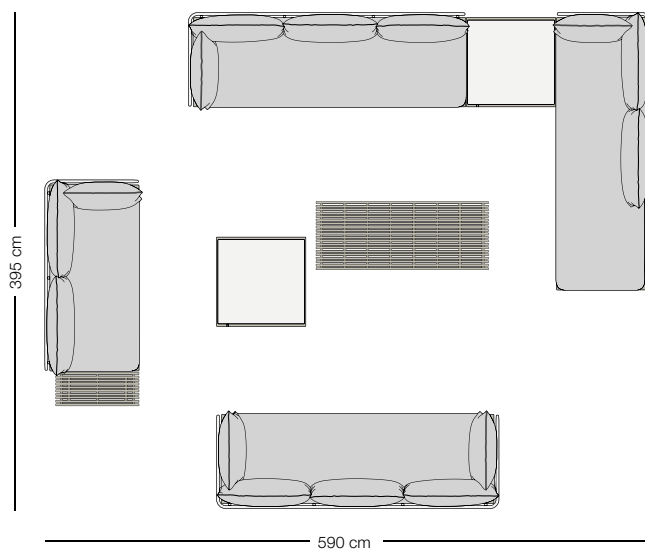

SEALINE Setting 02

- 1x **105004** – Right module XL, Dry+ cushion set
- 1x **105005** – Left module, Dry+ cushion set
- 1x **105015** – 3-Seater, Dry+ cushion set
- 1x **105017** – Extended daybed left, Dry+ cushion set
- 10x **95105297** – Dry+ additional back cushion
- 1x **105035205** – Coffee table 69 x 174 cm
- 2x **105033** – Coffee table 90 x 90 cm
- 1x **105011205** – Bench

Recommended deco cushions:

- 4x **95050081** – 40 x 40 cm
- 3x **95050082** – 50 x 50 cm

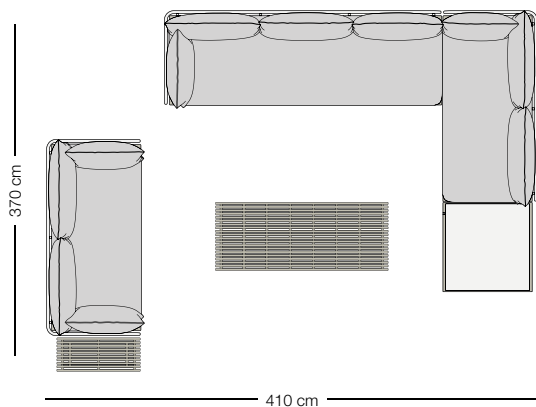

SEALINE Setting 03

- 1x **105003** – Right module, Dry+ cushion set
- 1x **105004** – Right module XL, Dry+ cushion set
- 1x **105012** – 2-Seater, Dry+ cushion set
- 7x **95105297** – Dry+ additional back cushion
- 1x **95105296** – Dry+ back cushion
- 1x **105035205** – Coffee table 69 x 174 cm
- 1x **105033** – Coffee table 90 x 90 cm
- 1x **105011205** – Bench

Recommended deco cushions:

- 5x **95050081** – 40 x 40 cm
- 4x **95050082** – 50 x 50 cm

For inspiration please see DEDON Lookbook 2020, pages 42/43



Recommended combinations

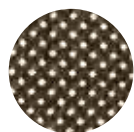

040
bronze

+

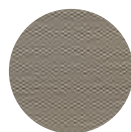

452
COOL taupe
Cat. A



662
TWIST gray
Cat. B



083
chalk

+



450
COOL white
Cat. A



660
TWIST beige
Cat. B

ARMCHAIR
 Armlehnstuhl
 Silla con brazos
 Poltrona pranzo
 Fauteuil repas
 4,8 kg 0,28 m³



049001040

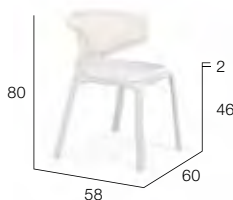

049001083

SEAT CUSHION
 Sitzkissen
 Cojín de asiento
 Cuscino seduta
 Coussin d'assise
 40 x 44 cm



049001

95049001

56049001000

SIDE CHAIR
 Essstuhl
 Silla de comedor
 Sedla pranzo
 Chaise repas
 4,6 kg 0,32 m³



049003040

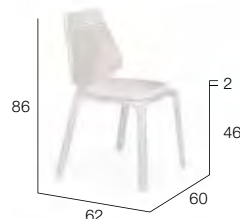

049003083

SEAT CUSHION
 Sitzkissen
 Cojín de asiento
 Cuscino seduta
 Coussin d'assise
 40 x 44 cm



049003

95049001

56049003000

LOUNGE CHAIR
 Sessel
 Sillón bajo
 Poltrona club
 Fauteuil club
 7,4 kg 0,55 m³



049005040



049005083

SEAT CUSHION
 Sitzkissen
 Cojín de asiento
 Cuscino seduta
 Coussin d'assise
 64 x 52 cm



049005

95049005

56049005000

2-SEATER
 Zer-Sofa
 Sofá 2 plazas
 Divano 2 posti
 Canapé 2 places
 12 kg 0,91 m³



049012040



049012083

SEAT CUSHION
 Sitzkissen
 Cojín de asiento
 Cuscino seduta
 Coussin d'assise
 132 x 55,5 cm



049012

95049012

56049012000

RECOMMENDED NUMBER OF DECO CUSHIONS

Empfohlene Dekokissenmenge
 Número de cojines decoración recomendados
 Numero di cuscini decorativi
 Nombre de coussins déco recommandé

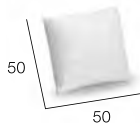

2x 95050082

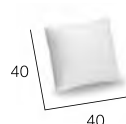

3x 95050081

FOOTSTOOL
 Hocker
 Taburete
 Puf
 Repose-pieds
 3,8 kg 0,11 m³



049031040



049031083

SEAT CUSHION
 Sitzkissen
 Cojín de asiento
 Cuscino seduta
 Coussin d'assise
 57 x 47 cm



049031

95049031

56049031000

SIDE TABLE
 Beistelltisch
 Mesa auxiliar
 Tavolino d'appoggio
 Table d'appoint
 47 x 47 cm
 2,5 kg 0,08 m³



049033040



049033083



049033

56049033000

BEACH CHAIR
 Sonnenliege
 Tumbona
 Lettino
 Chaise longue
 16 kg 0,67 m³



CUSHION
 Kissen
 Cojín
 Cuscino
 Coussin
 76 x 203 cm

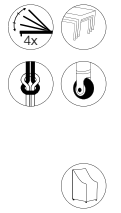

049020

049020040

049020083

95049020

56049020000

BARSTOOL
 Barhocker
 Taburete de bar
 Sgabello bar
 Tabouret de bar
 6 kg 0,34 m³

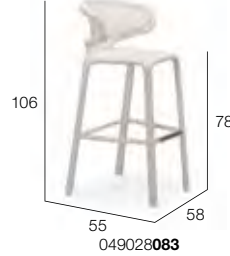

049028

049028040

049028083











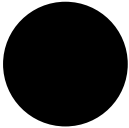

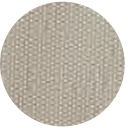

56049028000

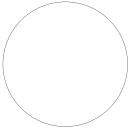

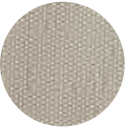





Combinations

Frame		Sling				
	+					
329		627	633	625	726	
black		sail shade	sail dove	sail taupe	sail elemental dark	
Frame		Sling				
	+					
317		625				
black pepper		sail taupe				
Frame		Sling				
	+					
000		627	633	625	725	727
white		sail shade	sail dove	sail taupe	sail elemental light	sail petrol light
Frame		Sling				
	+					
133		728				
nori		sail petrol dark				

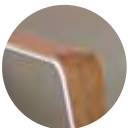
Armrests

	
with powder coated die-cast aluminum	with steam-bent teak-finished plywood

Tabletops

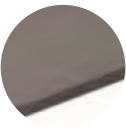
Teak	Mineral composite
	
205 teak	204 white
	
	203 ebony

ARMCHAIR
 Armlehnstuhl
 Silla con brazos
 Poltrona pranzo
 Fauteuil repas
 7 kg 0,26 m³



702311627



702301627



701311627



701301627

SEAT CUSHION
 Sitzkissen
 Cojín de asiento
 Cuscino seduta
 Coussin d'assise
 49 x 50 x 6 cm



95700001

56700001000



702311633



702301633



701311633



701301633



702311625



702301625



707311625



707301625



701311625



701301625



701311725



701301725



702311726



702301726



701311727



701301727



709311728



709301728

LOUNGE CHAIR

Sessel
Sillón bajo
Poltrona club
Fauteuil club
8 kg 0,32 m³

SEAT CUSHION + BACK CUSHION
Sitzkissen + Rückenkissen
Cojín de asiento + Cojín de respaldo
Cuscino seduta + Cuscino schienale
Coussin d'assise + Coussin de dossier
63 x 57 x 6 cm + 60 x 37 cm



702315627



702305627



701315627



701305627

95700005 56700005000



702315633



702305633



701315633



701305633



702315625



702305625



707315625



707305625



701315625



701305625



701315725



701305725



702315726



702305726



701315727



701305727



709315728



709305728

FOOTSTOOL
Hocker
Taburete
Pouf
Repose-pieds
5 kg 0,15 m³

SEAT CUSHION
Sitzkissen
Cojín de asiento
Cuscino seduta
Coussin d'assise
63 × 57 × 6 cm



702031627



701031627



702031633



701031633



702031625



707031625



701031625



701031725



702031726



701031727



7029031728

95700031

56700031000

EN The structure of the SEAX armchair and lounge chair is made of powder coated die-cast aluminum. The seat and back textile is a mix of PVC, acrylic and polyester. The armrest covers are made out of teak-finished plywood. Clean the frame, seat and backrest with a soft cloth and warm water. Clean the plywood armrest covers with a damp cloth and do not apply cleaning detergents of any kind. To maintain their beautiful wood finish, the SEAX armchairs and lounge chairs with plywood armrests should be protected from moisture and kept indoors when not in use. For a low-maintenance seating alternative, choose the armchair and lounge chair without plywood armrests.

DE Die Rahmen von SEAX Armlehnstuhl und Sessel bestehen aus pulverbeschichtetem, druckgegossenem Aluminium. Sitzfläche und Rückenlehne bestehen aus einem Stoff, der aus PVC, Acryl und Polyester gefertigt wird. Das Holzdekor der Armlehnen besteht aus mit Teakholz beschichtetem Schichtholz. Rahmen, Sitz und Lehne mit einem weichen Tuch und warmem Wasser reinigen. Die Schichtholz-Armlehnen reinigen Sie mit einem feuchten Tuch und niemals mit Reinigungsmitteln. Schützen Sie die SEAX Armlehnstühle und Sessel vor Feuchtigkeit und bewahren Sie sie im Innenbereich auf, wenn Sie sie nicht nutzen, damit die schöne Holzoberfläche nicht leidet. Als pflegeleichte Alternative wählen Sie den Armlehnstuhl oder den Sessel mit Armlehnen ohne Holzoberflächen.

ES El armazón de SEAX esta hecho de aluminio de fundición revestido de pintura en polvo. El asiento y el respaldo constan de un tejido mezcla de PVC, acrílico y poliéster. Las fundas de los reposabrazos son de madera contrachapada con acabados en teca. Limpie el marco, el asiento y el respaldo con un paño suave y agua tibia. Limpie las fundas de contrachapado de los reposabrazos con un paño húmedo y no aplique detergentes limpiadores de ningún tipo. Para mantener su bonito acabado en madera, las sillas con brazos y sillones bajos SEAX con reposabrazos en madera contrachapada deben estar protegidos contra la humedad y mantenerse en el interior cuando no se usen. Como alternativa para un bajo mantenimiento, escoja la silla con brazos y el sillón bajo sin reposabrazos de madera contrachapada.

IT La struttura SEAX è realizzata in alluminio pressofuso verniciato a polvere. La seduta e lo schienale sono in tessuto composto da PVC, fibra acrilica e poliestere. Le coperture dei braccioli sono in compensato con finiture in teak. Pulire il telaio, la seduta e lo schienale con un panno morbido e acqua calda. Pulire le coperture in compensato dei braccioli in compensato devono essere applicate detergenti di alcun tipo. Per mantenere la bellezza delle finiture in legno, le poltrone e poltrone club SEAX con braccioli in compensato devono essere protette dall'umidità e tenute all'interno, quando non vengono utilizzate. Se si desidera un'alternativa di seduta che non richieda molta manutenzione, scegliere le poltrone e le poltrone club senza braccioli in compensato.

FR La structure du fauteuil repas et du fauteuil club SEAX est fabriquée en aluminium coulé et laqué. Le siège et le dossier sont fabriqués dans un textile élaboré à partir de PVC, acrylique et polyester. Le revêtement des accoudoirs est en contreplaqué de teck. Nettoyez le cadre, le siège et le dossier avec un chiffon doux et de l'eau chaude. Nettoyez les accoudoirs avec un chiffon humide et n'utilisez jamais de détergent. Pour préserver leurs magnifiques finitions en bois, les fauteuils repas et les fauteuils club SEAX avec accoudoirs en contreplaqué de teck doivent être protégés de l'humidité et conservés à l'intérieur lorsqu'ils ne sont pas utilisés. Pour un choix d'entretien moins contraignant, choisissez le fauteuil repas et le fauteuil club sans accoudoirs en contreplaqué de teck.

ALL ITEMS ARE FOLDABLE.
Alle Produkte sind faltbar.
Todas las piezas son plegables.
Tutti gli articoli sono pieghevoli.
Tous les modèles sont pliables.



SEAT CUSHION ARMCHAIR
Sitzkissen Armlehnstuhl
Cojín de asiento Silla con brazos
Cuscino seduta Poltrona pranzo
Coussin d'assise Fauteuil repas



SEAT CUSHION + BACK CUSHION LOUNGE CHAIR
Sitzkissen + Rückenkissen Sessel
Cojín de asiento + cojín de respaldo sillón bajo
Cuscino seduta + cuscino schienale poltrona club
Coussin d'assise + coussin de dossier fauteuil club

SEAT CUSHION FOOTSTOOL
Sitzkissen Hocker
Cojín de asiento taburete
Cuscino seduta pouf
Coussin d'assise repose-pieds



Recommended cushion combinations

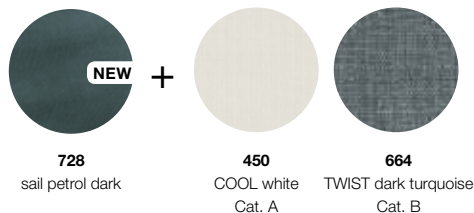
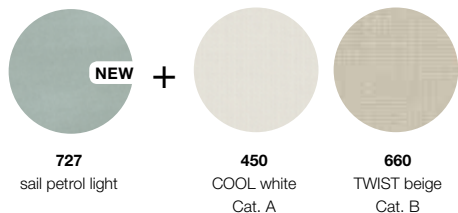
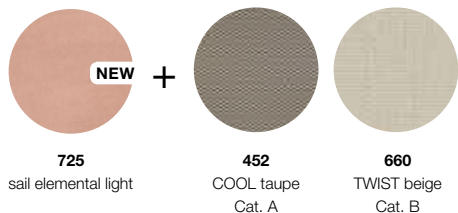
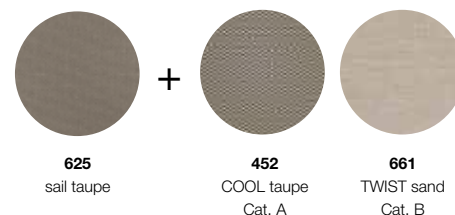
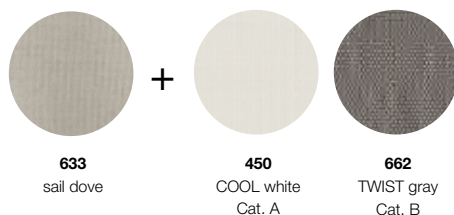
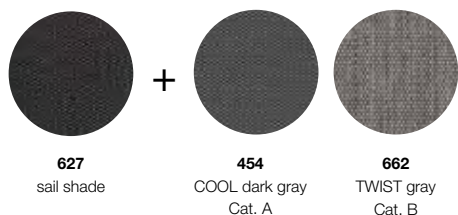

DINING TABLE
 Esstisch
 Mesa comedor
 Tavolo pranzo
 Table repas
100 x 100 cm
 40,5 kg 0,75 m³



Set: 702076204 *white / black*

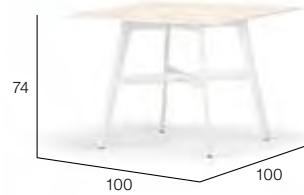

Set: 701076204 *white / white*

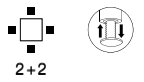

2+2



56700076000



Set: 702076203 *ebony / black*



Set: 701076203 *ebony / white*



Set: 702076205 *teak / black*

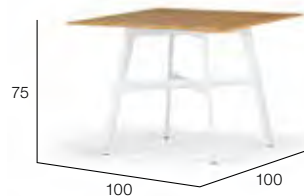

Set: 701076205 *teak / white*

30 kg 0,75 m³

DINING TABLE
 Esstisch
 Mesa comedor
 Tavolo pranzo
 Table repas
100 x 220 cm
 82 kg 1,65 m³



Set: 702040204 *white / black*

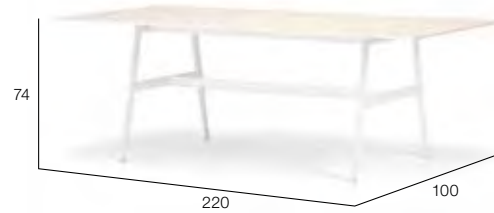

Set: 701040204 *white / white*

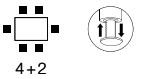

4+2



56700040000



Set: 702040203 *ebony / black*



Set: 701040203 *ebony / white*



52 kg 1,65 m³

Set: 702040205 *teak / black*

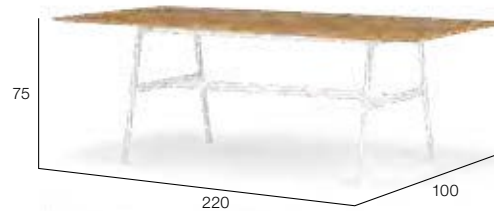

Set: 701040205 *teak / white*

DINING TABLE

Esstisch
Mesa comedor
Tavolo pranzo
Table repas
100 x 280 cm
99 kg 2,1 m³



Set: 702067204 white / black

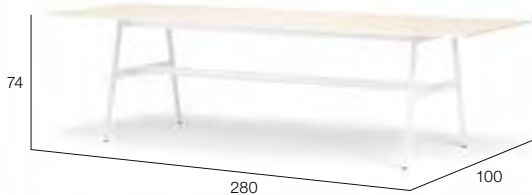

Set: 701067204 white / white

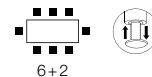

6+2



56700067000



Set: 702067203 ebony / black



Set: 701067203 ebony / white



Set: 702067205 teak / black

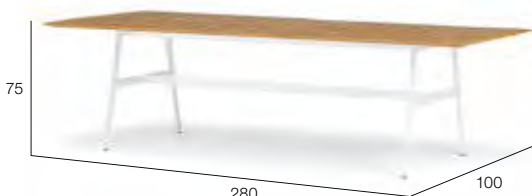

Set: 701067205 teak / white

63 kg 2,1 m³

DINING TABLE

Esstisch
Mesa comedor
Tavolo pranzo
Table repas
ø 140 cm
56,5 kg 1,47 m³



Set: 702046204 white / black



Set: 701046204 white / white



2+2



56700046000



Set: 702046203 ebony / black



Set: 701046203 ebony / white



Set: 702046205 teak / black



Set: 701046205 teak / white

39 kg 1,47 m³

Recommended powder coating color combinations

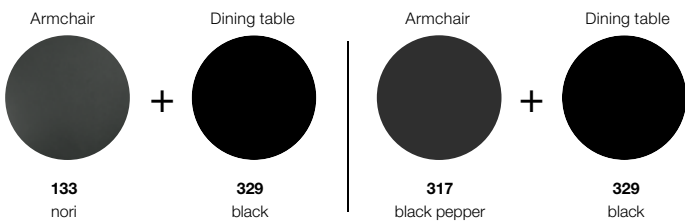

COFFEE TABLE

Kaffeetisch

Mesa de centro

Tavolino da salotto

Table de salon

ø 110 cm

40 kg 0,56 m³

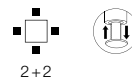

2+2



56700036000



Set: 702036204 white / black



ø 110
Set: 701036204 white / white



Set: 702036203 ebony / black



Set: 701036203 ebony / white



Set: 702036205 teak / black



ø 110
Set: 701036205 teak / white

23 kg 0,56 m³

EN The **base** consists of powder coated aluminum profiles with powder coated, die-cast aluminum legs.

Tabletops come in two options:

Ebony and white tabletops consist of a self-supporting mineral-composite slab, cut by water jet from the largest premium sintered porcelain slabs available on the market. Teak tabletop consists of premium teak. The sealant used between the teak slats are the same as those widely used on yacht decks and are designed to expand and contract with teak's natural movement.

DE Das **Gestell** besteht aus pulverbeschichteten Aluminium-Profilen mit pulverbeschichteten Aludruckgussbeinen. Die **Tischplatten** sind in zwei Varianten verfügbar: Ebony und White. Sie bestehen aus einem freitragenden Mineralverbundmaterial, das per Wasserstrahl aus den größten am Markt erhältlichen gesinterten Porzellanplatten geschnitten wird. Die Teak Tischplatte besteht aus hochwertigem Teakholz. Dichtungsfugen zwischen den Teakleisten erlauben dem Holz, sich im Rahmen seiner natürlichen Bewegung auszudehnen bzw. zusammenzuziehen.

ES La **base** combina perfiles de aluminio recubierto en polvo con patas de aluminio fundido recubierto en polvo. Los **tableros** están disponibles en dos opciones: ebony y white. Consisten en una placa autoportante de compuesto mineral que ha sido cortada mediante chorro de agua a partir de las placas de excelente porcelana sinterizada, las más grandes del mercado. El tablero de teca está elaborado con teca premium. Las juntas entre las lamas de teca, muy usadas en las cubiertas de los yates, permiten que la madera se expanda y se contraiga respetando su movimiento natural.

IT La **base** è composta da profili in alluminio con gambe in alluminio pressofuso e verniciatura a polvere.

Il **piano del tavolo** è disponibile in due colori: Presentati in ebano e bianco, i piani sono formati da lastre autoportanti in minerale composito tagliate a getto d'acqua e ricavate dalle più ampie lastre in porcellana sinterizzata di alta qualità disponibili sul mercato. Il piano in teak è realizzato con teak di alta qualità. Lo speciale sigillante inserito tra le assi è lo stesso utilizzato sui ponti degli yacht, ed è pensato per espandersi e restringersi assecondando i movimenti naturali del teak.

FR La **base** est fabriqué à partir de profilés en aluminium thermolaqué avec des pieds en aluminium moulé et thermolaqué.

Les **plateaux de tables** sont disponibles en deux variantes : ebony et white. Ils sont fabriqués dans un matériau minéral composite autoportant, lequel est découpé par jet hydraulique à partir des meilleures plaques de porcelaine frittées disponibles sur le marché. Le plateau de table est aussi proposé en teck de qualité supérieure. L'enduit entre les lamelles de teck est le même que celui utilisé sur les ponts de yachts : il est conçu pour gonfler et se contracter avec le mouvement naturel du teck.



Deck chair, sail shade
Seat cushion: black
Deck chair, sail taupe
Seat cushion: COOL taupe

Combinations

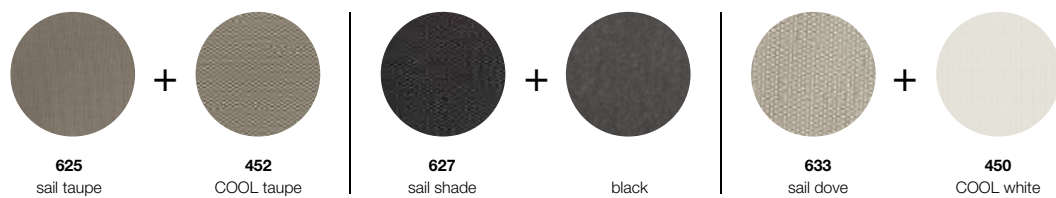

DECK CHAIR
 Liegestuhl
 Silla plegable
 Sedia a sdraio
 Transat
 10,2 kg 0,64 m³



102005627



102005633



102005625



102005

56102005000

SEAT CUSHION

Sitzkissen
 Cojín de asiento
 Cuscino seduta
 Coussin d'assise
 63 x 48 x 10 cm



95102005449

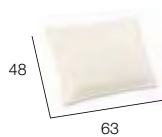

95102005450

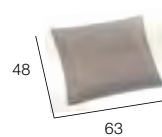

95102005452

EN The seat of the SEAYOU deck chair consists of a combination of SEAX sling material and outdoor fabric, while the base is made of premium teak. Clean the seat with a soft cloth and warm water. Clean the teak base with warm water in which natural soap flakes have been dissolved. The headrest cushion is removable. The fabric of the additional seat cushion corresponds to the fabric of the headrest cushion.

DE Die Sitzfläche des SEAYOU Liegestuhls besteht aus einer Kombination aus SEAX Slingmaterial und Outdoorstoff, während das Gestell aus hochwertigem Premiumteak gefertigt wird. Reinigen Sie die Sitzfläche mit einem weichen Tuch und warmem Wasser. Teak reinigen Sie am besten mit lauwarmem Wasser unter Hinzugabe von materialschonender Naturseife. Das Nackenkissen ist abnehmbar. Das optionale Sitzkissen wird in demselben Stoff gefertigt wie das Nackenkissen.









ES La superficie de la silla plegable SEAYOU es una combinación de material de tensor SEAX y tejido para exteriores, mientras que la base está fabricada de teca premium. Limpiar el asiento con un paño húmedo y agua tibia. Limpiar la teca con agua tibia en la que se haya disuelto jabón natural. El cojín reposacabezas es extraíble. El tejido del cojín adicional del asiento va a juego con el tejido del cojín del reposacabezas.

IT La seduta della sedia a sdraio SEAYOU è composta da una combinazione di fettucia in SEAX e di tessuto per esterni, mentre la base è in pregiato teak. Pulire la seduta con un panno morbido e acqua tiepida. Pulire la base in teak con acqua tiepida nella quale sono state dissolte scaglie di sapone naturale. Il cuscino poggiatesta è removibile. Il tessuto del cuscino della seduta aggiuntiva è coordinato al tessuto del cuscino poggiatesta.

FR Le siège du transat SEAYOU combine du matériel SEAX Sling et du tissu pour l'extérieur, le tout posé sur un cadre en teck de qualité supérieure. Utilisez un chiffon doux et de l'eau chaude pour nettoyer l'assise. Nettoyez les parties en teck avec de l'eau tiède, de préférence, agrémentée de savon naturel non agressif. Le coussin repose-tête est amovible. Le coussin d'assise en option est fabriqué avec le même tissu que le coussin repose-tête.



Recommended combinations

Fiber	Powder coating	Recommended fabric		Fiber	Powder coating	Recommended fabric	
		+	 			+	 
002 natural	304 lipari		450 COOL white Cat. A 660 TWIST beige Cat. B	083 chalk	304 lipari		450 COOL white Cat. A 660 TWIST beige Cat. B

HANGING LOUNGER*

Hanging lounger
Hanging lounger
Hanging lounger
Hanging lounger
45 kg 2,53 m³

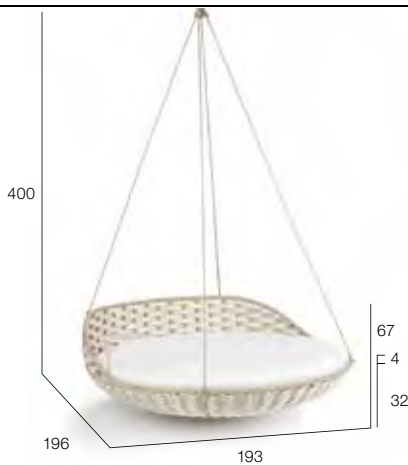

SEAT CUSHION
Sitzkissen
Cojín de asiento
Cuscino seduta
Coussin d'assise
ø 192 × 16 cm



091021

091021002

091021083

95090119

00091200002

CANOPY FOR HANGING LOUNGER

Himmel für Hanging lounger
Velo para Hanging lounger
Baldaquin pala Hanging lounger
Baldaquin pour Hanging lounger



400

00091100000

STANDING LOUNGER, INCL. BASE*

Standing lounger, inkl. Untersatz
Standing lounger, base incl.
Standing lounger, base incl.
Standing lounger, avec socle
52,2 kg 2,76 m³



SEAT CUSHION
Sitzkissen
Cojín de asiento
Cuscino seduta
Coussin d'assise
ø 192 × 16 cm



091023

091023002

091023083

95090119

00091200002

BASE, ROTATING – SUITABLE FOR HANGING AND STANDING LOUNGER

Untersatz, drehbar – passend für Hanging und Standing lounger
Base rotatoria – adaptable para el hanging y standing lounger
Base rotante – adatta per Hanging e Standing lounger
Socle, rotatif – convient pour Hanging lounger et Standing lounger
7,2 kg 0,15 m³



ø 121



091018

091018002

091018083

RECOMMENDED NUMBER OF DECO CUSHIONS

Empfohlene Dekokissenmenge
Número de cojines decoración recomendados
Numero di cuscini decorativi
Nombre de coussins déco recommandé

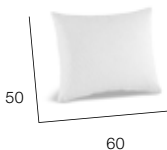

50

60

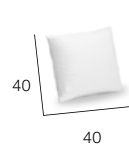

40

40

6x 95050087

4x 95050081

* EN Weight capacity 350 kg DE Tragkraft 350 kg ES Capacidad de carga 350 kg IT Portata 350 kg FR Capacité de charge 350 kg

SWINGME LOUNGE CHAIR*

SwingMe Sessel
SwingMe Columpio individual
SwingMe Poltrona club
SwingMe Fauteuil club
11 kg 0,36 m³



Set: 091017002

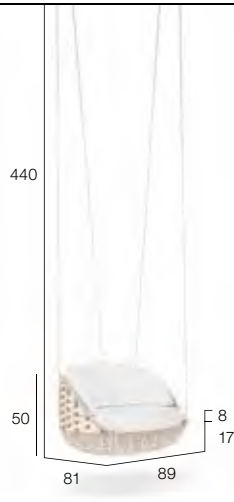

Set: 091017083

SEAT CUSHION
Sitzkissen
Cojín de asiento
Cuscino seduta
Coussin d'assise
85 x 78 cm

BACK CUSHION
Rückenkissen
Cojín de respaldo
Cuscino schienale
Coussin de dossier
152 x 29 cm



091005 + 091012000

LOUNGE CHAIR**

Sessel
Sillón bajo
Poltrona club
Fauteuil club
23 kg 0,51 m³



091007002



091007083

SEAT CUSHION
Sitzkissen
Cojín de asiento
Cuscino seduta
Coussin d'assise
85 x 78 cm

BACK CUSHION
Rückenkissen
Cojín de respaldo
Cuscino schienale
Coussin de dossier
152 x 29 cm



091007

RECOMMENDED NUMBER OF DECO CUSHIONS

Empfohlene Dekokissenmenge
Número de cojines decoración recomendados
Numero di cuscini decorativi
Nombre de coussins déco recommandé

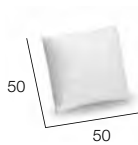

1x 95050082

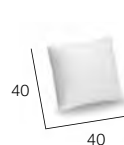

2x 95050081

SWINGUS 2-SEATER***

SwingUs 2er-Sofa
SwingUs Columpio 2 plazas
SwingUs Divanetto 2 posti
SwingUs Canapé 2 places
15 kg 0,54 m³



Set: 091015002



Set: 091015083

SEAT CUSHION
Sitzkissen
Cojín de asiento
Cuscino seduta
Coussin d'assise
124 x 78 cm

BACK CUSHION
Rückenkissen
Cojín de respaldo
Cuscino schienale
Coussin de dossier
204 x 29 cm



091012 + 091012000

* EN Weight capacity 120 kg DE Tragkraft 120 kg ES Capacidad de carga 120 kg IT Portata 120 kg FR Capacité de charge 120 kg
** EN Weight capacity 150 kg DE Tragkraft 150 kg ES Capacidad de carga 150 kg IT Portata 150 kg FR Capacité de charge 150 kg
*** EN Weight capacity 240 kg DE Tragkraft 240 kg ES Capacidad de carga 240 kg IT Portata 240 kg FR Capacité de charge 240 kg

EN Rope length may be customized upon request.

DE Die Seillänge kann auf Anfrage nach Kundenwünschen angepasst werden.

ES Se puede personalizar la longitud del cordón de acuerdo a los requisitos del cliente bajo pedido.

IT Il cliente puo ordinare la corda della lunghezza desiderata.

FR La longueur de la corde peut être modifiée sur demande et adaptée selon le souhait des clients.

CANOPY FOR SWINGUS 2-SEATER
 Himmel für SwingUs 2er-Sofa
 Velo para SwingUs Columpio 2 plazas
 Baldaquin para SwingUs Divanetto 2 posti
 Baldaquin pour SwingUs Canapé 2 places



00091015000

EN The SWINGREST canopy is made of 100% solution-dyed outdoor acrylic fabric with a color fastness of 7/8. It has a mold-resistant, soil-resistant and water-resistant finishing made with Teflon®. The aluminum ring is wrapped with rope.

DE Der SWINGREST Himmel besteht aus 100% spinnfärbem Outdoor-Acrylstoff mit einer Lichtechtheit von 7/8. Dank einer Teflon®-Beschichtung ist der Stoff schimmel-, schmutz- und wasserabweisend. Der Aluminiumring ist mit einem Seil umwickelt.

ES El velo SWINGREST está hecho de tejido acrílico 100% teñido en masa para exteriores con una solidez de color de 7/8. Cuenta con un acabado de Teflon® resistente al moho, la suciedad y el agua. La anilla de aluminio está revestida con cuerda acrílica.

IT La tenda SWINGREST è in tessuto per esterni 100% acrilico tinto in massa con una stabilità di colore di 7/8. Ha un rivestimento in Teflon® resistente alla muffa, allo sporco e all'acqua. L'anello di alluminio è rivestito di corda.

FR Le baldaquin SWINGREST est entièrement composé de matière acrylique teinte et adaptée à l'utilisation en extérieur, avec un indice de tenue de couleur de 7/8. Sa finition en Teflon® est résistante aux moisissures, à la salâté et à l'eau. Son anneau en aluminium est enveloppé de corde.

2-SEATER
 2er-Sofa
 Sofá 2 plazas
 Divanetto 2 posti
 Canapé 2 places
 15 kg 0,76 m³



SEAT CUSHION
 Sitzkissen
 Cojín de asiento
 Cuscino seduta
 Coussin d'assise
 124 x 78 cm

BACK CUSHION
 Rückenkissen
 Cojín de respaldo
 Cuscino schienale
 Coussin de dossier
 204 x 29 cm

091012+091013001

Set: 091014002

Set: 091014083

95091012

95091013

56091012000

RECOMMENDED NUMBER OF DECO CUSHIONS

Empfohlene Dekokissenmenge
 Número de cojines decoración recomendados
 Numero di cuscini decorativi
 Nombre de coussins déco recommandé

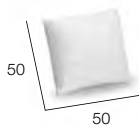

3x 95050082

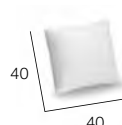

2x 95050081



EN The SwingMe Lounge chair and SwingUs 2-seater may be hung either from a single point, for a rotating swing experience, or from two points, for a back-and-forth one. The canopy for the SwingUs 2-seater fits only when the piece is hung from a single point.

DE Der SwingMe Sessel und das SwingUs 2er-Sofa können entweder an einem oder zwei Hängepunkten befestigt werden. Dadurch werden rotierende oder geradlinige Schaukelbewegungen erzielt. Der Himmel für das SwingUs 2er-Sofa kann nur befestigt werden, wenn das Möbelstück an einem einzigen Hängepunkt montiert wurde.

ES El sillón bajo SwingMe y el sofá de dos plazas SwingUs pueden colgarse en un solo punto para obtener un movimiento rotatorio o en dos puntos para conseguir un movimiento de balanceo. El baldaquin para el sofá de dos plazas SwingUs solo se puede fijar si este está colgado de un solo punto.

IT La poltrona SwingMe e il divano a due posti SwingUs possono essere appesi sia da un unico punto, con un effetto rotatorio e oscillante, sia da due punti, con un effetto di movimento avanti e indietro. La tenda per il divano a due posti SwingUs può essere collocata solo se il mobile è stato appeso da un unico punto.

FR Le fauteuil SwingMe et le canapé 2 places SwingUs peuvent être suspendus soit à partir d'un point d'attache unique, pour un balancement avec rotation, soit à partir de deux points d'attache différents, pour un balancement d'avant en arrière. Le baldaquin au-dessus du canapé 2 places SwingUs peut s'ajouter uniquement si le meuble est suspendu en un seul point.



Armchair

Recommended combinations



+



+

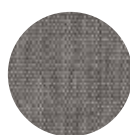
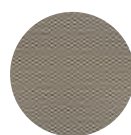

040
bronze

450
COOL white
Cat. A

660
TWIST beige
Cat. B

110
basalto

452
COOL taupe
Cat. A

662
TWIST gray
Cat. B

ARMCHAIR
 Armlehnstuhl
 Silla con brazos
 Poltrona pranzo
 Fauteuil repas
 6 kg 0,31 m³

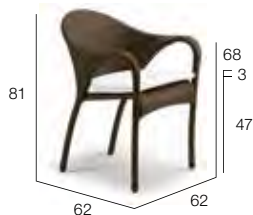

SEAT CUSHION
 Sitzkissen
 Cojín de asiento
 Cuscino seduta
 Coussin d'assise
 46 x 42 cm



026001

026001110

026001040

95026001

56026001000

DINING TABLE
 Esstisch
 Mesa comedor
 Tavolo pranzo
 Table repas
 ø 90 cm
 7 kg 0,61 m³



CLEAR GLASS TOP
 Klarglasplatte
 Sobre de cristal transparente
 Piano in vetro trasparente
 Plaque en verre clair
 9 kg



026045 + 026090

Set: 026046110

ø 90
 Set: 026046040

22226045000

56026046000

DINING TABLE
 Esstisch
 Mesa comedor
 Tavolo pranzo
 Table repas
 ø 130 cm
 10 kg 1,27 m³



CLEAR GLASS TOP
 Klarglasplatte
 Sobre de cristal transparente
 Piano in vetro trasparente
 Plaque en verre clair
 19 kg



026049 + 026099

Set: 026050110

ø 130
 Set: 026050040

22226049000

56026050000

DINING TABLE
 Esstisch
 Mesa comedor
 Tavolo pranzo
 Table repas
 130 x 220 cm
 22 kg 2,15 m³



CLEAR GLASS TOP
 Klarglasplatte
 Sobre de cristal transparente
 Piano in vetro trasparente
 Plaque en verre clair
 33,5 kg



026075 + 026095

Set: 026076110

Set: 026076040

22226075000

56026076000

LOUNGE CHAIR
 Sessel
 Sillón bajo
 Poltrona club
 Fauteuil club
 9 kg 0,7 m³



SEAT CUSHION + BACK CUSHION
 Sitzkissen + Rückenkissen
 Cojín de asiento + Cojín de respaldo
 Cuscino seduta + Cuscino schienale
 Coussin d'assise + Coussin de dossier
 61 x 58 cm + 50 x 60 cm



026005

026005110

026005040

95026005

56026005000

2-SEATER
 2er-Sofa
 Sofá 2 plazas
 Divano 2 posti
 Canapé 2 places
 15 kg 1,44 m³



SEAT CUSHION + 2x BACK CUSHIONS
 Sitzkissen + 2x Rückenkissen
 Cojín de asiento + 2x Cojines de respaldo
 Cuscino seduta + 2x Cuscini schienale
 Coussin d'assise + 2x Coussin de dossier
 132 x 58 cm + 2x 50 x 60 cm



026012

026012110

026012040

95026012

56026012000

Tabletop Glass



000 clear glass

BEACH CHAIR*
 Sonnenliege
 Tumbona
 Lettino
 Chaise longue
 17 kg 1,36 m³



CUSHION
 Kissen
 Cojín
 Cuscino
 Coussin
 60 x 206 cm



026119

026119110

026119040

95026019

56026019000

RECLINER*
 Liegesessel
 Sillón reclinable
 Poltrona reclinabile
 Fauteuil relax réglable
 13 kg 1 m³



CUSHION
 Kissen
 Cojín
 Cuscino
 Coussin
 60 x 136 cm



026109

026109110

026109040

95026009

56026009000

FOOTSTOOL
 Hocker
 Taburete
 Pouf
 Repose-pieds
 6 kg 0,13 m³



SEAT CUSHION
 Sitzkissen
 Cojín de asiento
 Cuscino seduta
 Coussin d'assise
 45 x 45 cm



026031

026031110

026031040

95026031

56026031000

SIDE TABLE
 Beistelltisch
 Mesa auxiliar
 Tavolino d'appoggio
 Table d'appoint
 ø 46 cm
 4 kg 0,11 m³



CLEAR GLASS TOP
 Klarglasplatte
 Sobre de cristal transparente
 Piano in vetro trasparente
 Plaque en verre clair
 2 kg



026033

Set: 026034110

Set: 026034040

22226033000

56026033000

* EN This item is also available with hook-catching mechanism upon request.

DE Dieser Artikel ist auf Anfrage auch mit Stufenverstellung erhältlich.

ES Bajo pedido este artículo también está disponible con un mecanismo de ajuste escalonado.

IT Questo articolo è disponibile su richiesta anche con meccanismo di regolazione reclinabile.

FR Cet article est disponible, sur demande, avec un mécanisme de réglage du niveau d'inclinaison.





6x Armchair
Cushion: LINEN warm gray
Dining table 103 x 278 cm

Recommended combinations



122
vulcano matte



205
teak

+



455
COOL marengo
Cat. A



652
LINEN warm gray
Cat. B

Recommended combinations: lounging



205
teak

+

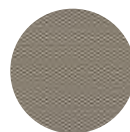

452
COOL taupe
Cat. A

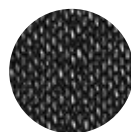

628
TWELLO night
Cat. B

ARMCHAIR
 Armlehnstuhl
 Silla con brazos
 Poltrona pranzo
 Fauteuil repas
 7 kg 0,3 m³



SEAT CUSHION
 Sitzkissen
 Cojín de asiento
 Cuscino seduta
 Coussin d'assise
 51 x 50 cm



CUSHION
 Kissen
 Cojín
 Cuscino
 Coussin
 56 x 102 cm



089001

95089003

089001122

95089002

56089001000

DINING TABLE
 Esstisch
 Mesa comedor
 Tavolo pranzo
 Table repas
 103 x 119 cm
 29 kg 0,9 m³



2+2



089075

089075205

56089075000

DINING TABLE
 Esstisch
 Mesa comedor
 Tavolo pranzo
 Table repas
 103 x 199 cm
 43 kg 1,5 m³



4+2



089065

089065205

56089065000

DINING TABLE
 Esstisch
 Mesa comedor
 Tavolo pranzo
 Table repas
 103 x 278 cm
 56 kg 2,1 m³



6+2



089055

089055205

56089055000

DINING TABLE
 Esstisch
 Mesa comedor
 Tavolo pranzo
 Table repas
 103 x 338 cm
 66 kg 2,6 m³



8+2



089045

089045205

56089045000

BENCH
 Bank
 Banco
 Panca
 Banc
 14 kg 0,25 m³

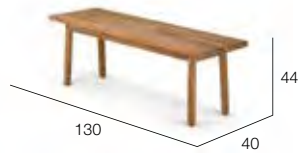

089012

089012205

56089012000

BENCH L
 Bank L
 Banco L
 Panca a L
 Banc L
 22 kg 0,35 m³

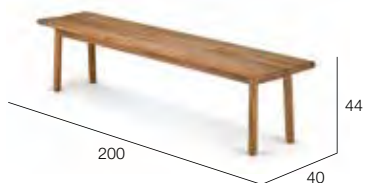

089015

089015205

56089015000

LOUNGE CHAIR

Sessel
Sillón bajo
Poltrona club
Fauteuil club
9 kg 0,36 m³



CUSHION
Kissen
Cojín
Cuscino
Coussin
69 x 109,5 cm



089005

089005122

95089005

56089005000

LOUNGE CHAIR XL

Sessel XL
Sillón bajo XL
Poltrona club XL
Fauteuil club XL
15,4 kg 0,85 m³



SEAT CUSHION + BACK CUSHION + 2x SIDE CUSHIONS
Sitzkissen + Rückenkissen + 2x Seitenkissen
Cojín de asiento + Cojín de respaldo + 2x Cojines lateral
Cuscino seduta + Cuscino schienale + 2x Cuscini laterale
Coussin d'assise + Coussin de dossier + 2x Coussins latéraux
93 x 95 cm + 47 x 95 cm + 2x 63 x 43 cm



089006

089006122

95089006

56089006000

2-SEATER

2er-Sofa
Sofá 2 plazas
Divano 2 posti
Canapé 2 places
30 kg 1,1 m³



SEAT CUSHIONS + BACK CUSHIONS + 2x SIDE CUSHIONS
Sitzkissen + Rückenkissen + 2x Seitenkissen
Cojines de asiento + Cojines de respaldo + 2x Cojines lateral
Cuscini seduta + Cuscini schienale + 2x Cuscini laterale
Coussins d'assise + Coussins de dossier + 2x Coussins latéral
190 x 93 cm + 190 x 47 cm + 2x 63 x 43 cm



089013

089013122

95089013

56089013000

3-SEATER

3er-Sofa
Sofá 3 plazas
Divano 3 posti
Canapé 3 places
35,4 kg 1,6 m³



SEAT CUSHIONS + BACK CUSHIONS + 2x SIDE CUSHIONS
Sitzkissen + Rückenkissen + 2x Seitenkissen
Cojines de asiento + Cojines de respaldo + 2x Cojines lateral
Cuscini seduta + Cuscini schienale + 2x Cuscini laterale
Coussins d'assise + Coussins de dossier + 2x Coussins latéral
285 x 93 cm + 285 x 47 cm + 2x 63 x 43 cm



089016

089016122

95089016

56089016000

COFFEE TABLE L

Kaffeetisch L
Mesa de centro L
Tavolino da salotto L
Table de salon L
103 x 139 cm
28,2 kg 0,5 m³



089037

089037205

56089037000

COFFEE TABLE

Kaffeetisch
Mesa de centro
Tavolino da salotto
Table de salon
80 x 80 cm
10 kg 0,2 m³



089035

089035205

56089035000

SIDE TABLE

Beistelltisch
Mesa auxiliar
Tavolino d'appoggio
Table d'appoint
60 x 40 cm
6 kg 0,09 m³

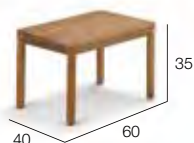

089039

089039205

56089039000

BEACH CHAIR
Sonnenliege
Tumbona
Lettino
Chaise longue
25,6 kg 0,46 m³



CUSHION
Kissen
Cojín
Cuscino
Coussin
75 x 206 cm



089019

089019205

95089019

56089019000

BEACH CHAIR
Sonnenliege
Tumbona
Lettino
Chaise longue
26 kg 0,46 m³



CUSHION
Kissen
Cojín
Cuscino
Coussin
75 x 206 cm



089020

089020205

95089019

56089019000

RECOMMENDED DECO CUSHIONS
Empfohlene Dekokissen
Cojines decoración recomendados
Cuscini decorativi consigliati
Coussins déco recommandés

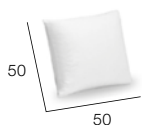

95050082

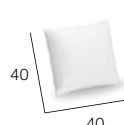

95050081

Tabletops teak



205 teak

TIBBO Dining table

TIBBO Coffee table (103 x 139 cm)



205 teak

TIBBO Side table

TIBBO Coffee table (80 x 80 cm)

EN The cover for the TIBBO beach chair can be applied only when the backrest is positioned straight up.

DE Die Husse der TIBBO Sonnenliegen ist nur bei aufgerichteter Rückenlehne zu verwenden.

ES La funda de la tumbona TIBBO solo puede colocarse cuando el respaldo está en posición vertical.

IT La fodera per il lettino TIBBO si può applicare solo quando lo schienale è sollevato.

FR La housse de la chaise longue TIBBO peut être utilisée uniquement lorsque le dossier est relevé.

EN The frames of the TIBBO armchair and lounge chair are made of premium teak, while the seats consist of woven DEDON fiber. The beach chair has marine-grade stainless steel hinges, which we recommend cleaning periodically to prevent stains. Clean TIBBO products with warm water in which natural soap flakes have been dissolved.

DE Die Rahmen der TIBBO Armlehnstühle und Sessel bestehen aus hochwertigem Teakholz, während die Sitzflächen aus geflochtener DEDON-Faser gefertigt werden. Die Scharniere der Sonnenliege bestehen aus rostfreiem Stahl (schiffbauliche „marine-grade“ Qualität). Wir empfehlen diese Verbindungen regelmäßig zu reinigen, um Flecken zu vermeiden. Die Möbel der TIBBO Kollektion reinigen Sie mit lauwarmem Wasser unter Hinzugabe von materialschonender Naturseife.

ES La estructura de la silla y el sillón bajo TIBBO están hechos de madera de teca de alta calidad, mientras que los asientos se componen de fibra tejida DEDON. Las bisagras de la tumbona están fabricadas de acero inoxidable (calidad naval "marine grade"). Se recomienda limpiar periódicamente estas uniones para evitar manchas. Lavar con agua templada y jabón natural en copos bien disuelto.

IT I telai della poltrona e della poltrona club TIBBO sono realizzati in teak di prima qualità, mentre le sedute sono in fibra intrecciata DEDON. Le cerniere del lettino sono in acciaio INOX (di qualità ad uso navale). Si raccomanda di pulirle regolarmente per impedire la formazione di macchie. Pulire i prodotti TIBBO con una soluzione composta da poco sapone neutro disciolto in acqua tiepida.

FR Les cadres du fauteuil repas et du fauteuil club TIBBO sont en teck de qualité supérieure. Les sièges sont, eux, fabriqués en fibre DEDON tissée. Les charnières des baignoires de soleil se composent d'acier inoxydable (identique à celui utilisé dans la construction navale). Nous recommandons un entretien régulier de ces charnières, afin d'éviter la formation de taches. Nettoyez les produits TIBBO avec du savon naturel en paillettes dilué dans de l'eau chaude.

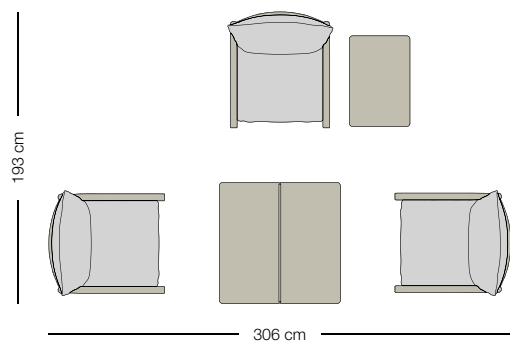

TIBBO Setting 01

- 3x 089005** – Lounge chair incl. cushion
- 1x 089039205** – Side table
- 1x 089035205** – Coffee table

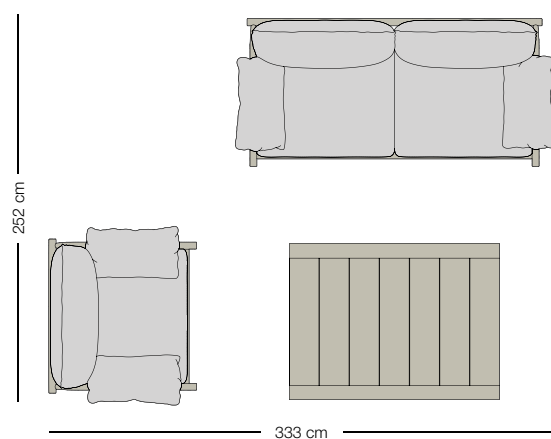

TIBBO Setting 02

- 1x 089013** – 2-Seater incl. cushions
- 1x 089006** – Lounge chair XL incl. cushions
- 1x 089037205** – Coffee table L 103 x 139 cm

Recommended deco cushions:

- 1x 95050081** – 40 x 40 cm
- 1x 95050085** – 50 x 40 cm

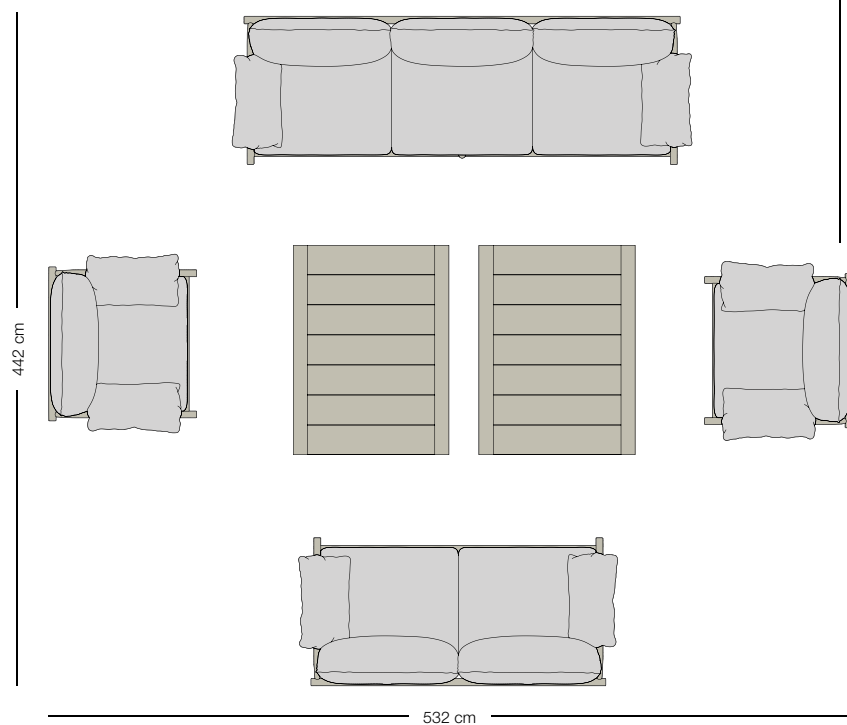

TIBBO Setting 03

- 1x 089016** – 3-Seater incl. cushions
- 2x 089006** – Lounge chair XL incl. cushions
- 2x 089037205** – Coffee table L 103 x 139 cm
- 1x 089013** – 2-Seater incl. cushions

Recommended deco cushions:

- 4x 95050081** – 40 x 40 cm
- 3x 95050085** – 50 x 40 cm



2-Seater
Cushion: TWELLO night
Coffee table 103 x 139 cm



Deep sofa with roof (removable)
Cushion: COOL white

Recommended combinations





002
lipari + natural roof

450
COOL white
Cat. A

662
TWIST gray
Cat. B





083
lipari + chalk roof

450
COOL white
Cat. A

662
TWIST gray
Cat. B

DEEP SOFA WITH ROOF (REMOVABLE)
 Tiefes Sofa mit Dach (abnehmbar)
 Sofá con mayor profundidad con dosel (desmontable)
 Divano con seduta profonda con tettuccio (removibile)
 Canapé à assise profonde avec toit (amovible)
 70 kg 5,6 m³

SEAT CUSHION + 2x BACK CUSHIONS + 2x SIDE CUSHIONS
 Sitzkissen + 2x Rückenkissen + 2x Seitenkissen
 Cojín de asiento + 2x Cojines de respaldo + 2x Cojines lateral
 Cuscino seduta + 2x Cuscini schienale + 2x Cuscini laterale
 Coussin d'assise + 2x Coussin de dossier + 2x Coussin latéral
 183 x 94 cm + 2x 98 x 50 cm + 2x 98 x 45 cm



076018098 + 076017002

Set: 076019002

143

95076018

56076019000



DEEP SOFA WITH ROOF (REMOVABLE)
 Tiefes Sofa mit Dach (abnehmbar)
 Sofá con mayor profundidad con dosel (desmontable)
 Divano con seduta profonda con tettuccio (removibile)
 Canapé à assise profonde avec toit (amovible)
 70 kg 5,6 m³

SEAT CUSHION + 2x BACK CUSHIONS + 2x SIDE CUSHIONS
 Sitzkissen + 2x Rückenkissen + 2x Seitenkissen
 Cojín de asiento + 2x Cojines de respaldo + 2x Cojines lateral
 Cuscino seduta + 2x Cuscini schienale + 2x Cuscini laterale
 Coussin d'assise + 2x Coussin de dossier + 2x Coussin latéral
 183 x 94 cm + 2x 98 x 50 cm + 2x 98 x 45 cm



076018098 + 076017083

Set: 076019083

143

95076018

56076019000



DEEP SOFA
 Tiefes Sofa
 Sofá con mayor profundidad
 Divano con seduta profonda
 Canapé à assise profonde
 32 kg 2,35 m³

SEAT CUSHION + 2x BACK CUSHIONS + 2x SIDE CUSHIONS
 Sitzkissen + 2x Rückenkissen + 2x Seitenkissen
 Cojín de asiento + 2x Cojines de respaldo + 2x Cojines lateral
 Cuscino seduta + 2x Cuscini schienale + 2x Cuscini laterale
 Coussin d'assise + 2x Coussin de dossier + 2x Coussin latéral
 183 x 94 cm + 2x 98 x 50 cm + 2x 98 x 45 cm



076018

076018098

95076018

56076018000



EN This item comes with a set of base cushions made out of sling fabric for the seat, back and sides. Sling is a quick-drying, easy-to-clean polyester material with exceptional resistance to tearing and to outdoor conditions such as UV-light exposure. The base seat cushion is made out of a quick-drying foam. For better comfort, we recommend ordering a second layer of cushions made from our standard fabrics.

DE Dieser Artikel kommt mit einem Set aus Sitz-, Rücken- und Seitenkissen aus Sling-Stoff. Dieses schnelltrocknende und leicht zu reinigende Polyestermaterial ist sehr UV-beständig und reißfest. Das Sitzkissen hat einen schnelltrocknenden Schaumstoffkern. Zusätzlich kann eine zweite Lage Kissen zur Verbesserung des Komforts bestellt werden. Dieses ist erhältlich in unseren Standardstoffen.

ES El artículo incluye un asiento así como cojines laterales y de respaldo. Los cojines están cubiertos con textiles sling; un material polyester de secado rápido y fácil limpieza con resistencia excepcional a desgarres y uso en exterior, incluyendo exposición solar. El asiento está hecho con espuma de secado rápido. Para un mejor confort, se recomienda adquirir la segunda capa de cojines que puede ser ordenada en cualquiera de nuestras telas en catálogo.

IT L'articolo viene con un set base di cuscini per seduta, schienale e laterale fatto in sling, un materiale poliestere ad asciugatura rapida, facile da pulire con un'eccezionale resistenza agli strappi ed alle condizioni esterne come l'esposizione ai raggi UV. La base del cuscino della seduta ha un'imbottitura ad asciugatura rapida. Per un miglior confort, raccomandiamo ordinare un secondo strato fatto nei nostri tessuti standard.

FR Cet article est livré avec un set de coussins comprenant un coussin d'assise, un coussin de dossier et un coussin latéral, tous recouverts de toile sling. Cette toile en fils polyester sèche très rapidement et est réputée pour sa facilité d'entretien, son extrême solidité et son exceptionnelle résistance aux conditions extérieures, notamment son exposition aux UV. Le coussin d'assise est composé d'une mousse à séchage rapide. Pour un meilleur confort, nous vous conseillons de commander des coussins de revêtement, conçus avec nos textiles habituels.



Dining table 100 x 200 cm
white / HPL white

Tabletops HPL



000
white

304
lipari 2.0

305
vulcano

Tabletops glass



304
lipari glass
Bottom: lacquered in lipari

305
vulcano glass
Bottom: lacquered in vulcano

Tabletop teak



205
teak

DINING TABLE
 Esstisch
 Mesa comedor
 Tavolo pranzo
 Table repas
100 x 100 cm



601079001 white / HPL white



603079306 lipari / HPL lipari 2.0



604079099 vulcano / HPL vulcano



56057075000

34 kg 0,74 m³



601077098 white / glass lipari



603077098 lipari / glass lipari



604077099 vulcano / glass vulcano

45,5 kg 0,74 m³



601060205 white / teak



603060205 lipari / teak

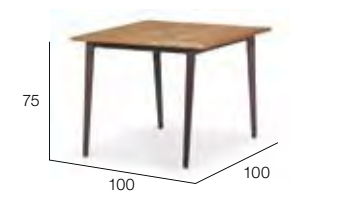

604060205 vulcano / teak

39,5 kg 0,75 m³

DINING TABLE
 Esstisch
 Mesa comedor
 Tavolo pranzo
 Table repas
100 x 200 cm



601071001 white / HPL white



603071306 lipari / HPL lipari 2.0



604071099 vulcano / HPL vulcano

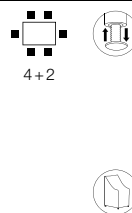

56057065000

50 kg 1,48 m³



601073098 white / glass lipari



603073098 lipari / glass lipari



604073099 vulcano / glass vulcano

73,5 kg 1,48 m³



601062205 white / teak



603062205 lipari / teak



604062205 vulcano / teak

44 kg 1,5 m³

DINING TABLE
 Esstisch
 Mesa comedor
 Tavolo pranzo
 Table repas
100 x 250 cm



601064205 white / teak



603064205 lipari / teak



604064205 vulcano / teak

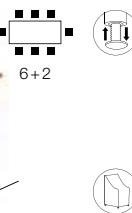

56600064000

49,5 kg 1,9 m³



AIR Armchair
See page 15



PANAMA Armchair
See page 101



PLAY Armchair
See page 105



RILLY Armchair
See page 119



MBRACE Armchair
See page 96



SEASHELL Armchair
See page 133

EN The WA table is available with a high-pressure laminate (HPL) top, a glass top and a teak top. HPL is a non-toxic material that is highly resistant to impact, mechanical stress, moisture and steam. Single-layered tempered glass offers increased resistance to temperature changes as well as excellent resistance to bending, impact and shock. The teak tabletop support structure consists of powder coated aluminum profiles, while the legs consist of die-cast powder coated aluminum. Clean the support structure and legs with a soft cloth and warm water.

DE Der WA Tisch ist verfügbar mit einer „High Pressure Laminate“ (HPL) Platte, einer Glasplatte sowie einer Teak-Tischplatte. HPL ist ein ungiftiges Material, das sich durch hohe Stoßfestigkeit und extreme Widerstandskraft gegen mechanische Einwirkungen, Feuchtigkeit und Dampf auszeichnet. Das Einscheibensicherheitsglas verfügt über eine verbesserte Temperaturwechselbeständigkeit und weist eine sehr gute Biege-, Schlag- und Stoßfestigkeit auf. Die Teak Tischplatte besteht aus hochwertigem Teakholz. Die Beine sind aus gegossenem, pulverbeschichtetem Aluminium gefertigt. Einfach mit einem weichen Tuch und warmem Wasser zu reinigen.

ES Los tableros de la mesa WA están disponibles en tablero laminado a alta presión (HPL), cristal y teca. El HPL es un material no tóxico y muy resistente a impactos, cargas mecánicas, humedad y vapor. El cristal de seguridad monocapa ofrece una alta resistencia a los cambios de temperatura, así como a la flexión, a los impactos y a los golpes. El tablero de teca está hecho con teca de primera calidad. La estructura del soporte del tablero WA está hecha con perfiles de aluminio recubiertos en polvo, mientras que las patas son de aluminio fundido recubierto en polvo. Limpiar la estructura del soporte y las patas con un paño suave y agua tibia.

IT Il tavolo WA è disponibile con piano in laminato ad alta pressione (HPL), piano in vetro o piano in teak. L'HPL è un materiale atossico con elevata resistenza agli impatti, alle sollecitazioni meccaniche, all'umidità e al vapore. Il vetro di sicurezza a strato singolo offre una resistenza maggiore agli sbalzi di temperatura, alla flessione, agli impatti e agli urti. Il piano del tavolo è realizzato con teak di alta qualità. La struttura di sostegno del piano è formata da profili di alluminio verniciati a polvere, mentre le gambe del tavolo sono in alluminio pressofuso verniciato a polvere. Pulire la struttura di sostegno e le gambe con un panno morbido e acqua tiepida.

FR La table WA est disponible avec un plateau en stratifié haute pression (HPL), un plateau en verre, un plateau Slim Box en acier inoxydable et un plateau en teck. Le HPL est un matériau non toxique extrêmement résistant aux chocs, aux contraintes mécaniques, à l'humidité et à la vapeur. L'épaisseur unique en verre de protection résiste mieux aux changements de température ainsi qu'au poids, aux impacts et aux chocs. Le plateau de table est fabriqué dans un teck de grande qualité. La structure de support du plateau est fabriquée en profilés d'aluminium à revêtement poudre. Les pieds sont en aluminium moulé sous pression à revêtement poudre. Nettoyer avec un chiffon doux à l'eau chaude.



WA dining table 100 × 200 cm,
white / HPL white
AIR armchairs, salt

LIGHTING & ACCESSORIES







Lantern M, terra + optional set of eyes, midday
 Statue LIKA + optional set of eyes, midnight
 Lantern S, forest

Fiber lantern S



128
cloud

127
forest

Fiber lantern M



128
cloud

129
terra

Fiber lantern L

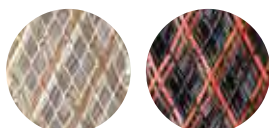

128
cloud

130
rock

Further material



Handmade acrylic
eyes, mosaic style

Marble base in
nero marquina

Premium
teak spacer

LANTERN S
 Laterne S
 Farolillo S
 Lanterna S
 Lanterne S
ø 45 cm
 10,1 kg 0,11 m³



093010128



093010127



093010

LANTERN M
 Laterne M
 Farolillo M
 Lanterna M
 Lanterne M
ø 45 cm
 10,6 kg 0,14 m³



093020128



093020129



093020

LANTERN L
 Laterne L
 Farolillo L
 Lanterna L
 Lanterne L
ø 45 cm
 11,2 kg 0,17 m³



093030128



093030130

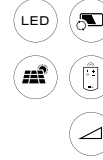

093030

LANTERN HANGING S
 Hängende Laterne S
 Farolillo colgante S
 Lanterna pendente S
 Lanterne suspendue S
ø 45 cm
 3 kg 0,09 m³



093040128



093040127



093040

LANTERN HANGING M
 Hängende Laterne M
 Farolillo colgante M
 Lanterna pendente M
 Lanterne suspendue M
ø 45 cm
 3,6 kg 0,12 m³



093050128



093050129



093050

LANTERN HANGING L
 Hängende Laterne L
 Farolillo colgante L
 Lanterna pendente L
 Lanterne suspendue L
ø 45 cm
 4,2 kg 0,15 m³



093060128



093060130



093060

OPTIONAL SET OF EYES
 Optionales Augenset
 Kit opcional de ojos
 Kit occhi, opzionale
 Kit optionnel yeux



sunrise
 093092001



midday
 093092002



midnight
 093092003

093092



96 cm

ø 45 cm

STATUE TEBU
Statue TEBU
Estatua TEBU
Statua TEBU
Statue TEBU
ø 45 cm
12,9 kg 0,19 m³

093100000



126 cm

ø 45 cm

STATUE LIKA
Statue LIKA
Estatua LIKA
Statua LIKA
Statue LIKA
ø 45 cm
14,1 kg 0,26 m³

093110000



124 cm

ø 45 cm

STATUE JAMA
Statue JAMA
Estatua JAMA
Statua JAMA
Statue JAMA
ø 45 cm
13,2 kg 0,26 m³

093120000



139 cm

ø 45 cm

STATUE KAFA
Statue KAFA
Estatua KAFA
Statua KAFA
Statue KAFA
ø 45 cm
13,5 kg 0,29 m³

093150000



96 cm

ø 45 cm

STATUE BUKA
Statue BUKA
Estatua BUKA
Statua BUKA
Statue BUKA
ø 45 cm
12,9 kg 0,19 m³

093130000



139 cm

ø 45 cm

STATUE TOBO
Statue TOBO
Estatua TOBO
Statua TOBO
Statue TOBO
ø 45 cm
13,9 kg 0,29 m³

093140000



EN This lighting object is a decorative element for outdoor and indoor use and features a warm white correlated color temperature (2700 Kelvin). It has an ingress protection marking for LED module by IP64, which means it is dustproof, splashproof and therefore fully suitable for outdoor use. There are two ways of charging the LED module, by solar panel and by power adapter. Energy efficiency EEC A+.

These luminaires contain built-in LED lamps. The lamps cannot be changed in the luminaires. THE OTHERS components are made with DEDON Fiber, premium teak, Italian marble and acrylic mosaic. Clean teak with warm water in which natural soap flakes have been dissolved. Custom-made compositions may be specially ordered.

DE Diese Leuchte ist ein dekoratives Objekt für den Innen- und Außenbereich mit einer warmweißen Farbtemperatur (2700 Kelvin). Das LED-Modul hat die Schutzklasse IP64 gegen Eindringen von Wasser und Schmutz, ist also staubdicht und spritzwassergeschützt und somit absolut geeignet für den Einsatz im Außenbereich. Aufladen lassen sich die LED-Module auf zweierlei Arten: über Solarmodule oder ein Netzkabel. Energieeffizienzklasse EEC A+.

Die Leuchten enthalten eingebaute LED-Lampen, die nicht ausgetauscht werden können. Die Elemente der THE OTHERS Kollektion bestehen aus DEDON-Faser, Premium-Teak, italienischem Marmor und Acrylmosaik. Teak-Elemente mit lauwarmem Wasser reinigen, in dem natürliche Seifenflocken vollständig aufgelöst wurden. Kundenindividuelle Kombinationen sind bestellbar.

ES Esta lámpara es un objeto decorativo para exteriores e interiores con una temperatura de color blanco cálido (2700 Kelvin). El módulo LED posee la clase de protección IP 64, lo que significa que es a prueba de polvo y de salpicaduras y, por lo tanto, adecuado para su uso en exteriores. Eficiencia energética: IEE A+.

Estas lámparas incorporan luces LED. Las luces no se pueden sustituir en las lámparas. Los elementos de THE OTHERS están elaborados con fibra DEDON, teca de primera calidad, mármol italiano y mosaico acrílico. Limpiar la teca con agua tibia después de que el jabón natural se haya disuelto. Se pueden encargar composiciones personalizadas.

IT Questa lampada è un oggetto decorativo per esterni e interni e sono caratterizzati da una temperatura di colore bianco caldo (2700 Kelvin). Il modulo LED è in classe di protezione IP 64, vale a dire a tenuta di polvere e protetto dall'umidità ed è pertanto idoneo per l'uso in ambiente esterno. Efficienza energetica: EEK A+.

Queste lampade contengono lampadine a LED integrate. Non è possibile sostituire le lampadine all'interno delle lampade. I componenti della collezione THE OTHERS sono: fibra DEDON, teak di qualità premium, marmo italiano e mosaico acrilico. Il modo migliore per pulire il teak è usare acqua tiepida con l'aggiunta di sapone neutro che non danneggi il materiale. Combinazioni personalizzabili su richiesta.

FR Cette lampe est un objet de décoration destiné à un usage à l'intérieur comme à l'extérieur, avec une température de couleur blanc chaud (2700 kelvins). Le module LED est doté de la classe de protection IP 64, ce qui signifie qu'il étanche à la poussière et aux éclaboussures, et donc parfaitement adapté à un usage à l'extérieur. Le module LED se charge de 2 manières: soit via un panneau solaire, soit via un câble électrique. Efficacité énergétique: EEK A+.

Ces luminaires sont avec des lampes LED intégrées, qui ne peuvent pas être remplacées. Les éléments de la collection THE OTHERS sont en fibre DEDON, en teck de première qualité, en marbre originaire d'Italie et en mosaïque acrylique. Nettoyez le teck avec de l'eau chaude dans laquelle ont été dissous des copeaux de savon naturel. Il est possible de commander des compositions personnalisées.





Floor lamp L
Floor lamp S

Material



Polyethylene
off white



Teak

FLOOR LAMP S
Bodenleuchte S
Lámpara de pie S
Lampada da pavimento S
Lampe sur pied S
ø 42 cm
3,2 kg 0,12 m³



101010000

FLOOR LAMP L
Bodenleuchte L
Lámpara de pie L
Lampada da pavimento L
Lampe sur pied L
ø 54 cm
6,3 kg 0,27 m³



101030000

EN This lighting object is a decorative element for outdoor and indoor use and features a warm white correlated color temperature (2700 Kelvin). It has an ingress protection marking for LED module by IP64, which means it is dustproof, splashproof and therefore fully suitable for outdoor use. Energy efficiency eec A+.

These luminaires contain builtin LED lamps. The lamps cannot be changed in the luminaires. LOON consists of rotomolded polyethylene and a premium teak base. Clean teak base with warm water in which natural soap flakes have been dissolved.

DE Diese Leuchte ist ein dekoratives Objekt für den Innen- und Außenbereich mit einer warmweißen Farbtemperatur (2700 Kelvin). Das LED-Modul hat die Schutzklasse IP64 gegen Eindringen von Wasser und Schmutz, ist also staubdicht und spritzwassergeschützt und somit absolut geeignet für den Einsatz im Außenbereich. Energieeffizienzklasse EEK A+.

Die Leuchten enthalten eingebaute LED-Lampen, die nicht ausgetauscht werden können. LOON besteht aus im Rotationsgussverfahren gefertigtem Polyethylen mit einem Untergestell aus Teak. Das Teak-Gestell mit lauwarmem Wasser reinigen, in dem natürliche Seifenflocken vollständig aufgelöst wurden.

ES Esta lámpara es un objeto decorativo para exteriores e interiores con una temperatura de color blanco cálido (2700 Kelvin). El módulo LED posee la clase de protección IP 64, lo que significa que es a prueba de polvo y de salpicaduras y, por lo tanto, adecuado para su uso en exteriores. Eficiencia energética: IEE A+.

Estas lámparas incorporan luces LED. Las luces no se pueden sustituir en las lámparas. LOON consiste de una base hecha en teca de primera calidad y una pantalla de polietileno rotomoldeado. Lavar con agua templada y jabón natural en copos bien disuelto.

IT Questa lampada è un oggetto decorativo per esterni e interni ed è caratterizzata da una temperatura di colore bianco caldo (2700 Kelvin). Il modulo LED è in classe di protezione IP 64, vale a dire a tenuta di polvere e protetto dall'umidità ed è pertanto idoneo per l'uso in ambiente esterno. Efficienza energetica: EEK A+.

Queste lampade contengono lampadine a LED integrate. Non è possibile sostituire le lampadine all'interno delle lampade. LOON è una lampada in polietilene (PE) rotostampato montata su un telaio in teak. Il modo migliore per pulire il teak è usare acqua tiepida con l'aggiunta di sapone neutro che non danneggi il materiale.

FR Cette lampe est un objet de décoration destiné à un usage à l'intérieur comme à l'extérieur, avec une température de couleur blanc chaud (2700 kelvins). Le module LED est doté de la classe de protection IP 64, ce qui signifie qu'il étanche à la poussière et aux éclaboussures, et donc parfaitement adapté à un usage à l'extérieur. Le module LED se charge de 2 manières: soit via un panneau solaire, soit via un câble électrique. Efficacité énergétique: EEK A+.

Ces luminaires sont avec des lampes LED intégrées, qui ne peuvent pas être remplacées. LOON est composé de polyéthylène rotomoulé et d'une base en teck de première qualité. Nettoyez la base en teck avec de l'eau chaude dans laquelle ont été dissous des copeaux de savon naturel.





Side table PE, incl. light

Material

Polyethylene



off white

STOOL / SIDE TABLE PE, INCL. LIGHT
Hocker / Beistelltisch PE, inkl. Licht
Asiento / Mesa auxiliar PE, lámpara incluida
Pouf / Tavolino PE, luce inclusa
Tabouret / Table d'appoint PE, lampe comprise
ø 52,5 cm
5,3 kg 0,12 m³



053112000

EN This lighting object is a decorative element for outdoor and indoor use and features a warm white correlated color temperature (2700 Kelvin). It has an ingress protection marking for LED module by IP64, which means it is dustproof, splashproof and therefore fully suitable for outdoor use. Energy efficiency eec A+. These luminaires contain built-in LED lamps. The lamps cannot be changed in the luminaires.

BABYLON PE consists of rotomolded polyethylene. For more BABYLON products, please see pages 20/21 and 176.

DE Diese Leuchte ist ein dekoratives Objekt für den Außen- und Innenbereich mit einer warmweißen Farbtemperatur (2700 Kelvin). Das LED-Modul hat die Schutzklasse IP 64, ist also staubdicht und spritzwassergeschützt und somit absolut geeignet für die Verwendung im Außenbereich. Energieeffizienz EEK A+: Diese Leuchten enthalten eingebaute LED-Lampen. Die Lampen können in den Leuchten nicht ausgetauscht werden.

BABYLON PE ist aus Rotationsguss-gefertigtem Polyethylen (PE) hergestellt. Für weitere BABYLON Produkte blättern Sie auf Seite 20/21 und 176.

ES Esta lámpara es un objeto decorativo para exteriores e interiores con una temperatura de color blanco cálido (2700 Kelvin). El módulo LED posee la clase de protección IP 64, lo que significa que es a prueba de polvo y de salpicaduras y, por lo tanto, adecuado para su uso en exteriores. Eficiencia energética: IEE A+. Estas lámparas incorporan luces LED. Las luces no se pueden sustituir en las lámparas.

La colección BABYLON PE está fabricada de polietileno rotomoldeado. Para ver más productos de BABYLON, consulte las páginas 20/21 y 176.

IT Questa lampada è un oggetto decorativo per esterni e interni, caratterizzata da una temperatura di colore bianco caldo (2700 Kelvin). Il modulo LED è in classe di protezione IP 64, vale a dire a tenuta di polvere e protetto dall'umidità ed è pertanto idoneo per l'uso in ambiente esterno. Efficienza energetica: EEK A+. Queste lampade contengono lampadine a LED integrate. Non è possibile sostituire le lampadine all'interno delle lampade.

BABYLON PE è realizzato in polietilene (PE) rotostampato. Potete vedere gli altri prodotti BABYLON a pagina 20/21 e 176.

FR Cette lampe est un objet de décoration destiné à un usage à l'intérieur comme à l'extérieur, avec une température de couleur blanc chaud (2700 kelvins). Le module LED est doté de la classe de protection IP 64, ce qui signifie qu'il étanche à la poussière et aux éclaboussures, et donc parfaitement adapté à un usage à l'extérieur. Le module LED se charge de 2 manières : soit via un panneau solaire, soit via un câble électrique. Efficacité énergétique : EEK A+. Ces luminaires sont avec des lampes LED intégrées, qui ne peuvent pas être remplacées.

BABYLON PE est composé de polyéthylène rotomoulé. Pour découvrir d'autres produits BABYLON, consultez les pages 20/21 et 176.





2x Planter L

Material



300
chalk



307
copper

PLANTER L
Übertopf L
Cubretiesto L
Portavaso L
Cache-pot L
ø 87 cm
30 kg 0,76 m³



053084**300**



ø 53
053084**307**

INTERIOR VIEW
Innenansicht
Vista interior
Vista interna
Vue intérieure

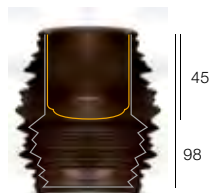

EN The BABYLON Planter is a dual-walled planter the volume of which can vary depending on the size of the plant. Made of roto-moulded polyethylene (PE): 100% approved for outdoor use, easy to maintain, 100% recyclable, light yet robust at the same time.

DE Der BABYLON Planter ist ein doppelwandiger Übertopf, dessen Volumen je nach Pflanzengröße variiert werden kann. Aus rotationsguss gefertigtem Polyethylen (PE) hergestellt: 100% Outdoor-Verwendung, einfach zu pflegen, gleichzeitig leicht und widerstandsfähig, 100% recyclingfähig.

ES BABYLON Planter es un macetero de pared doble cuyo volumen puede variar según el tamaño de la planta. Fabricado en polietileno rotomol-deado (PE): 100% para uso en exteriores, de fácil mantenimiento, ligero y al mismo tiempo resistente, 100% reciclable.

IT BABYLON Planter è un vaso a doppia parete, il cui volume può essere adattato in base alle dimensioni della pianta. Fabricato in polietilene rotostampato: adatto al 100% ad un utilizzo in ambienti esterni, di facile manutenzione, leggero e allo stesso tempo resistente, 100% riciclabile.

FR BABYLON Planter est un cache-pot à double paroi dont le volume peut être adapté en fonction de la taille de la plante. En Polyéthylène (PE) rotomoulié : 100% adapté au plein air, facile d'entretien, à la fois léger et résistant. 100% recyclable.



Carpet FRINGES, 200 x 300 cm, canvas

Material

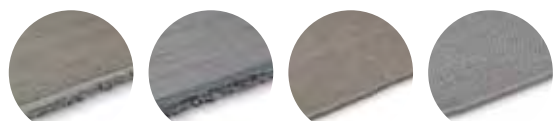

125
FRINGES
canvas

124
FRINGES
light gray

125
SOLID
canvas

124
SOLID
light gray

CARPET FRINGES
Teppich FRINGES
Alfombra FRINGES
Tappeto FRINGES
Tapis FRINGES
200 x 300 cm



098030**125**



098030**124**

CARPET SOLID
Teppich SOLID
Alfombra SOLID
Tappeto SOLID
Tapis SOLID
200 x 300 cm



098020**125**



098020**124**

CARPET SOLID
Teppich SOLID
Alfombra SOLID
Tappeto SOLID
Tapis SOLID
300 x 400 cm

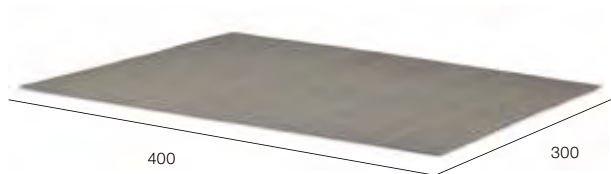

098025**125**

EN VID is handwoven and consists of 100% polypropylene. Designed and treated for outdoor use, it is UV- and weather-resistant. We recommend to lift the carpet periodically to let it dry.

DE VID ist handgewebt und besteht aus 100% Polypropylen. Der Teppich ist witterungsbeständig, hat eine hohe UV-Resistenz und eignet sich für den Einsatz im Außenbereich. Wir empfehlen, den Teppich regelmäßig anzuheben, um ihn vollständig zu trocknen.

ES VID está tejido a mano y está compuesto de 100% polipropileno. La alfombra es resistente a la intemperie, es altamente resistente a los rayos UV y es adecuada para utilizarse al aire libre. Se recomienda levantar periódicamente la alfombra para secarla completamente.

IT VID è tessuto a mano e composto al 100% di polipropilene. Il tappeto è resistente agli agenti atmosferici e ai raggi UV e adatto all'utilizzo all'aperto. Si raccomanda di sollevare il tappeto regolarmente per garantirne l'asciugatura completa.

FR Le tapis VID, 100 % polypropylène, est tissé à la main. Il résiste aux intempéries, présente une haute résistance aux UV et se prête à une utilisation à l'extérieur. Nous vous conseillons de surélever régulièrement le tapis afin qu'il sèche entièrement.

DALA PLANTER & LANTERN

Design by STEPHEN BURKS



Planter ø 61 cm
 Planter ø 76 cm
 Lantern ø 21 cm
 Lantern ø 34 cm
 Lantern ø 41 cm

Planter



533
grass

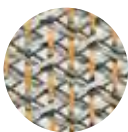

534
stone

Lantern

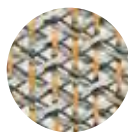

534
stone

PLANTER S
 Übertopf S
 Cubretiesto S
 Portavaso S
 Cache-pot S
ø 61 cm
 5 kg 0,17 m³



073050**533**

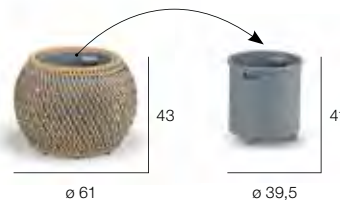

073050**534**

PLANTER M
 Übertopf M
 Cubretiesto M
 Portavaso M
 Cache-pot M
ø 61 cm
 5 kg 0,23 m³



073052**533**

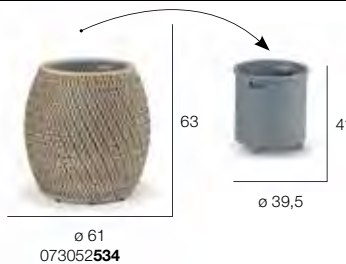

073052**534**

PLANTER L
 Übertopf L
 Cubretiesto L
 Portavaso L
 Cache-pot L
ø 76 cm
 8 kg 0,48 m³



073051**533**

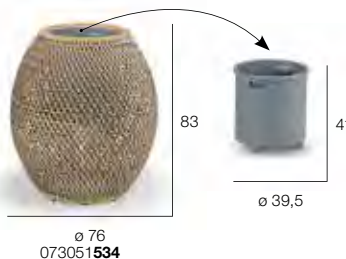

073051**534**

<p>LANTERN Laterne Farolillo Lanterna Lanterne ø 21 cm 1 kg 0,02 m³</p>		<p>HANGER FOR LANTERN Ø 21 CM Aufhängung für Laterne ø 21 cm Elemento de suspensión para el farolillo ø 21 cm Supporto per lanterna ø 21 cm Accessoire de suspension pour lanterne ø 21 cm</p>	
<p>073060</p>	<p>073060534</p>	<p>HANGER FOR LANTERN Ø 34 CM AND Ø 41 CM Aufhängung für Laterne ø 34 cm und ø 41 cm Elemento de suspensión para el farolillo ø 34 cm y ø 41 cm Supporto per lanterna ø 34 cm e ø 41 cm Accessoire de suspension pour lanterne ø 34 cm et ø 41 cm</p>	
<p>LANTERN Laterne Farolillo Lanterna Lanterne ø 34 cm 2 kg 0,06 m³</p>		<p>073061</p>	<p>073092000</p>
<p>073062</p>	<p>073062534</p>	<p>LANTERN Laterne Farolillo Lanterna Lanterne ø 41 cm 2,5 kg 0,11 m³</p>	

EN The removable inner planter consists of rotomolded polyethylene. The removable candle holder consists of a metal candle plate and a plastic tube. For the small DALA lantern (height 32 cm), use only a block **candle** with a maximum height of 8 cm and a maximum diameter of 11 cm. For the medium and large DALA lanterns (heights 47 and 62 cm), use only a block candle with a maximum height of 22 cm and a maximum diameter of 17 cm.

DE Der herausnehmbare innere Behälter wurde in Rotationsgusstechnik aus Polyethylen gefertigt. Der herausnehmbare Kerzenhalter besteht aus einem Kerzenteller aus Metall und einem Kerzenschutz aus Kunststoff. Die **Kerzen** sollten für die kleine DALA Laterne (Höhe 32 cm) eine Höhe von 11 cm und einen Durchmesser von 8 cm nicht überschreiten. Die Kerzen für die DALA Laternen mittlerer und großer Größe (Höhe 47 und 62 cm) sollten nicht höher als 22 cm sein und einen maximalen Durchmesser von 17 cm nicht überschreiten. Verwenden Sie bitte ausschließlich Blockkerzen.

ES Recipiente interior extraíble de polietileno rotomoldeado. El portavelas desmontable está compuesto por un plato metálico y un tubo plástico. Para el farolillo DALA pequeño (altura 32 cm) utilice únicamente una **vela** con una altura máxima de 11 cm y un diámetro máximo de 8 cm. Para los farolillos DALA mediano y grande (altura 47 y 62 cm) utilice únicamente una vela con una altura máxima de 22 cm y un diámetro máximo de 17 cm.

IT Il portalamпада amovibile si compone di un piatto metallico e di un cilindro in plastic. Per la lanterna DALA piccola (altezza 32 cm), utilizzare esclusivamente **candele** cilindriche con altezza massima di 11 cm e diametro massimo di 8 cm. Per le lanterne DALA medie e grandi (altezza 47 e 62 cm), utilizzare esclusivamente candele cilindriche con altezza massima di 22 cm e diametro massimo di 17 cm.

FR L'intérieur amovible du cache pot est en polyéthylène rotomoulé. Le bougeoir amovible est composé d'une soucoupe en métal et d'un tube en plastique. Pour la lanterne DALA (32 cm de hauteur), utiliser une seule **bougie** mesurant 11 cm de hauteur max. et 8 cm de diamètre max. Pour les lanternes DALA de moyenne et grande taille (47 et 62 cm de hauteur), utiliser une bougie mesurant 22 cm de hauteur max. et 17 cm de diamètre max. N'utiliser que des bougies pleines



Square M - cantilever, anthracite

Materials



+



327
white



+



328
anthracite

SQUARE S
260 x 260 cm

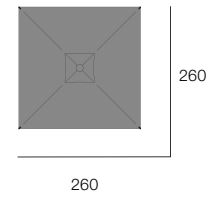
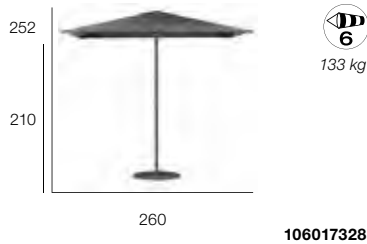
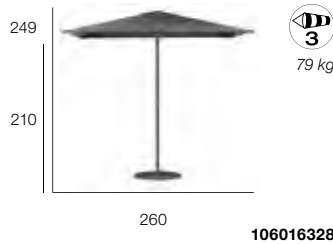
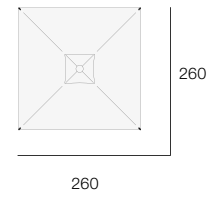
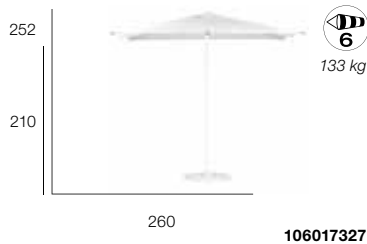
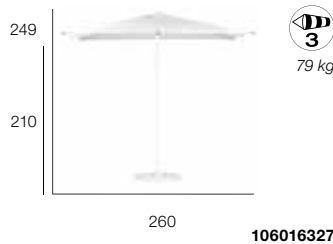

HEXAGON S
287 x 260 cm

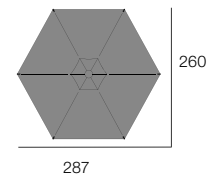
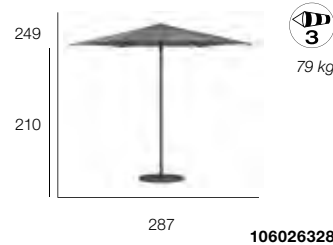
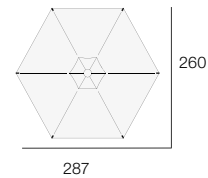
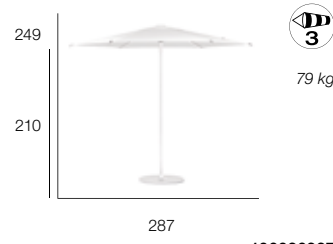

SQUARE M
350 x 350 cm

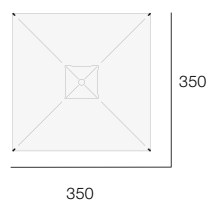
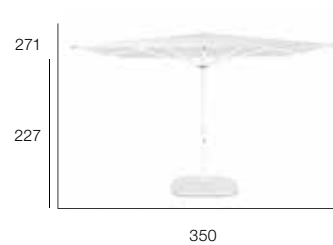

106039327

106094327

106095327

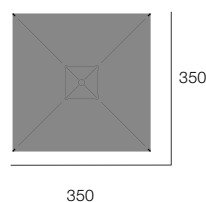
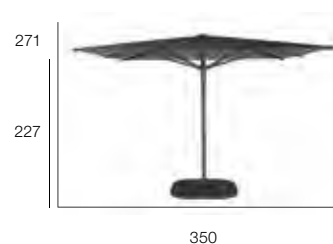

106039328

106094328

106095328



EN This item is available in two base configurations, for wind grade 3 (12-19 km/h) or wind grade 6 (39-49 km/h), the latter featuring additional steel weights. See icon for number of wind force.

DE Das Produkt ist mit zwei verschiedenen Ständervarianten erhältlich, die für Windstärke 3 (12-19 km/h) bzw. Windstärke 6 (39-49 km/h) geeignet sind; letztere Variante ist mit zusätzlichen Stahlgewichten ausgestattet. Die Windstärke ist mit einem Symbol angegeben.

ES Este producto está disponible en dos configuraciones posibles para la base: para una fuerza del viento 3 (12-19 km/h) o una fuerza del viento 6 (39-49 km/h). En el último caso, también cuenta con pesos de acero adicionales. Ver icono para encontrar el número de la fuerza del viento.

IT Questo articolo è disponibile in due configurazioni di base, per vento di grado 3 (12-19 km/h) o vento di grado 6 (39-49 km/h), quest'ultima con pesi aggiuntivi in acciaio. Vedi l'icona per il grado di forza eolica.

FR Le produit est disponible en deux variantes de support, pour une force de vent 3 (12-19 km/h) et pour une force de vent (39-49 km/h); cette dernière est munie de poids en acier supplémentaires. La force de vent est indiquée par un symbole.

SQUARE M – CANTILEVER
300 x 300 cm

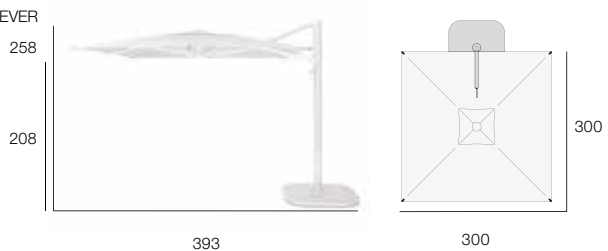

262 kg



410 kg

In-ground mounting kit



Concrete mounting kit



393

300

106058327

106059327

106096327

106097327

included



262 kg



410 kg

In-ground mounting kit



Concrete mounting kit



393

300

106058328

106059328

106096328

106097328

included

RECTANGULAR L – CANTILEVER
302 x 400 cm

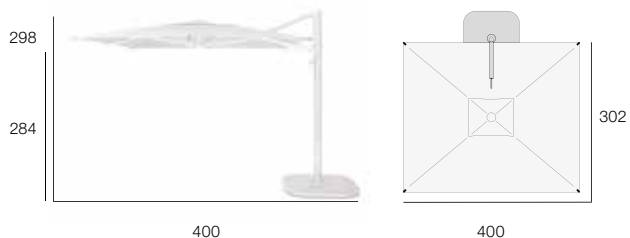

420 kg

In-ground mounting kit



Concrete mounting kit



400

400

106089327

106090327

106091327

included

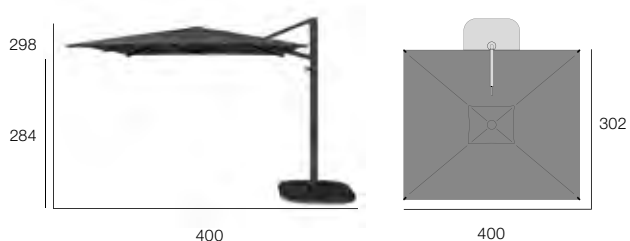

420 kg

In-ground mounting kit



Concrete mounting kit



400

400

106089328

106090328

106091328

included

IN-GROUND MOUNTING KIT

Montagesatz zur Bodenbefestigung im Erdboden

Kit de montaje bajo suelo

Kit di montaggio interrato

Kit de montage au sol

7,8 kg 0,12 m³

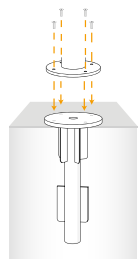

106092000

CONCRETE MOUNTING KIT

Montagesatz zur Bodenbefestigung im Betonboden

Kit de montaje en hormigón

Kit di montaggio in cemento

Kit de montage en béton

4,8 kg 0,004 m³

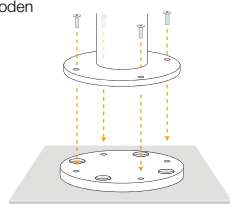

106093000

EN Mounting kits will achieve wind grade 6 (39-49 km/h) and are available for square M, square M cantilever and rectangular L cantilever only. For further ground mounting safety instructions, please check www.dedon.de/reav and consult the assembly instruction. It is the responsibility of the customer to provide a safe and suitable foundation.

DE Mit einem Bodenmontagesatz wird ebenfalls Standsicherheit bei Windstärken bis 6 (39-49 km/h) erreicht. Der Montagesatz ist nur für die Modelle Square M, Square M Cantilever und Rectangular M Cantilever erhältlich. Weitere Sicherheitshinweise für die Bodenmontage finden Sie auf www.dedon.de/reav und in der Montageanleitung. Es obliegt dem Kunden, für einen geeigneten, sicheren Untergrund zu sorgen.

ES Los kits de montaje resisten una fuerza 6 (39-49 km/h) y solo están disponibles para el cantilever cuadrado M y el cantilever rectangular L. Para más instrucciones de seguridad sobre el montaje en el suelo, consulte www.dedon.de/reav y lea las instrucciones de ensamblaje. Es la responsabilidad del cliente garantizar que los cimientos sean seguros y adecuados.

IT Con i kit di montaggio si arriva a vento di grado 6 (39-49 km/h). Questi kit sono disponibili soltanto per M quadrato, M quadrato a braccio laterale e L rettangolare a braccio laterale. Per ulteriori istruzioni di sicurezza riguardanti il montaggio a terra visitare www.dedon.de/reav e consultare le istruzioni di montaggio. È responsabilità del cliente provvedere a un basamento sicuro e idoneo.

FR Les kits de montage atteignent la classe de vent 6 (39-49 km/h) et ne sont disponibles que pour les parasols carrés M, Cantilever M carré et Cantilever L rectangulaire. Pour obtenir des consignes de sécurité supplémentaires à propos du montage au sol, veuillez consulter le site Internet www.dedon.de/reav et la notice de montage. Il est de la responsabilité du client de fournir une base sûre et adaptée.



INFORMATION





COPYRIGHT

EN INTELLECTUAL PROPERTY RIGHTS AND COPYRIGHT

The DEDON Collections have been exclusively designed by our company or developed for us by designers. All designs are registered. DEDON GmbH holds the copyrights for all products. All products carry the "DEDON" label. Our trademark is protected by law. Any infringement of our rights will be prosecuted.

Beyond that, the following premium materials have been utilized:

- Batyline® is a registered trademark of The Serge Ferrari SA, France
- Ferrari Stamoid® is a registered trademark of The Serge Ferrari Group, France
- Monolite Ipergres® is a registered trademark of Laboratorio Pesaro S.r.l., Italy
- Teflon® is a registered trademark of E. I. du Pont de Nemours and Company, USA
- WeatherMax® is a registered trademark of Safety Components Fabric Technologies, Inc., USA
- Tempotest® is a registered trademark of Para' S.P.A., Italy
- RESOPAL® is a registered trademark of Wilsonart Engineered Surfaces, USA
- Sunbrella® is a registered trademark of Glen Raven, Inc., USA

DE GEWERBLICHE SCHUTZRECHTE UND URHEBERRECHT

Alle DEDON-Kollektionen wurden in unserem Unternehmen design't oder wurden exklusiv von Designern für uns entwickelt. Die Designs sind als eingetragene Geschmacksmuster geschützt. Die urheberrechtlichen Nutzungsrechte für alle Produkte liegen bei der DEDON GmbH. Alle Erzeugnisse sind mit unserem Markenzeichen „DEDON“ gekennzeichnet. Unser Markenzeichen ist gesetzlich geschützt. Jeder Verstoß gegen unsere Rechte wird von uns verfolgt.

Folgende Premiummaterialien werden darüber hinaus eingesetzt:

- Batyline® ist eine eingetragene Marke der Firma The Serge Ferrari SA, Frankreich
- Ferrari Stamoid® ist eine eingetragene Marke der Firma The Serge Ferrari SA, Frankreich
- Monolite Ipergres® ist eine eingetragene Marke der Firma Laboratorio Pesaro S.r.l., Italien
- Teflon® ist eine eingetragene Marke der Firma E. I. du Pont de Nemours and Company, USA
- WeatherMax® ist eine eingetragene Marke der Firma Safety Components Fabric Technologies, Inc., USA
- Tempotest® ist eine eingetragene Marke der Firma Para' S.P.A., Italien
- RESOPAL® ist eine eingetragene Marke der Firma Wilsonart Engineered Surfaces, USA
- Sunbrella® ist eine eingetragene Marke der Firma Glen Raven, Inc., USA

ES PROPIEDAD INDUSTRIAL Y DERECHOS DE AUTOR

Las colecciones DEDON han sido diseñadas por nuestra empresa o desarrolladas en exclusiva para nosotros por diseñadores. Los diseños gozan de la protección de diseños registrados. DEDON GmbH mantiene los derechos de autor sobre todos los productos. Los artículos y productos llevan la marca "DEDON", nuestra marca protegida por ley. Cualquier infracción contra nuestros derechos será perseguida judicialmente.

Se utilizan además los siguientes materiales premium:

- Batyline® es una marca registrada de The Serge Ferrari SA, Francia
- Ferrari Stamoid® es una marca registrada de The Serge Ferrari Group, Francia
- Monolite Ipergres® es una marca registrada de Laboratorio Pesaro S.r.l., Italia
- Teflon® es una marca registrada de E. I. du Pont de Nemours and Company, Estados Unidos
- WeatherMax® es una marca registrada de Safety Components Fabric Technologies, Inc., Estados Unidos
- Tempotest® es una marca registrada de Para' S.P.A., Italia
- RESOPAL® es una marca registrada de Wilsonart Engineered Surfaces, USA
- Sunbrella® es una marca registrada de Glen Raven, Inc., USA

IT PROPRIETÀ INTELLETTUALE E COPYRIGHT

Le collezioni DEDON sono state disegnate esclusivamente dalla nostra azienda o sono state sviluppate per noi dai nostri designer. Tutti i modelli sono registrati. DEDON GmbH detiene il copyright di ogni prodotto. Tutti i prodotti recano l'etichetta "DEDON". Il nostro marchio è protetto dalla legge. Qualsiasi violazione dei nostri diritti verrà perseguita.

Vengono inoltre utilizzati i seguenti materiali di alta qualità:

- Batyline® è un marchio registrato di The Serge Ferrari SA, Francia
- Ferrari Stamoid® è un marchio registrato di The Serge Ferrari SA, Francia
- Monolite Ipergres® è un marchio registrato di Laboratorio Pesaro S.r.l., Italia
- Teflon® è un marchio registrato di E. I. du Pont de Nemours and Company, USA
- WeatherMax® è un marchio registrato di Safety Components Fabric Technologies, Inc., USA
- Tempotest® è un marchio registrato di Para' S.P.A., Italia
- RESOPAL® è un marchio registrato di Wilsonart Engineered Surfaces, USA
- Sunbrella® è un marchio registrato di Glen Raven, Inc., USA

FR MODÈLE ET DROITS D'AUTEUR

Toutes les collections DEDON ont été exclusivement conçues par nos soins ou ont été développées pour nous par des designers. Les modèles ont été déposés. DEDON GmbH détient les droits de propriété intellectuelle pour tous ses produits. Tous les produits portent la marque « DEDON ». Notre marque déposée est protégée par la loi. Toute violation de nos droits donnera lieu à une action en justice.

Les matériaux premium suivants sont également utilisés :

- Batyline® est une marque déposée de The Serge Ferrari SA, France
- Ferrari Stamoid® est une marque déposée de The Serge Ferrari SA, France
- Monolite Ipergres® est une marque déposée de Laboratorio Pesaro S.r.l., Italie
- Teflon® est une marque déposée de E. I. du Pont de Nemours and Company, USA
- WeatherMax® est une marque déposée de Safety Components Fabric Technologies, Inc., USA
- Tempotest® est une marque déposée de S.P.A., Italie
- RESOPAL® est une marque déposée de Wilsonart Engineered Surfaces, USA
- Sunbrella® est une marque déposée de Glen Raven, Inc., USA

© 2019 DEDON GmbH, Germany. The photographs featured in our catalogs and on our website are protected by United States and international copyright laws and may not be reproduced without the express written permission of DEDON GmbH or DEDON, Inc.

Photographs of products appearing to be suspended in space, in an unnatural recreational manner or over water may be simulations created by professionals. Do not attempt to recreate these applications on your own.



CAPTION

"Set:"	For tables, item numbers noted with "Set" include the table and corresponding tabletop.
"Set:"	Artikelnummern für Tische, die mit dem Zusatz "Set" gekennzeichnet sind, beziehen sich sowohl auf den Tisch als auch auf die jeweilige Tischplatte.
"Set:"	Para las mesas, los números de artículos que llevan anotado "Set" incluyen la mesa y su correspondiente tablero.
"Set:"	Nel caso dei tavoli, i numeri articolo contrassegnati con "Set" includono sia il tavolo che il piano tavolo corrispondente.
"Set:"	Concernant les tables, les numéros d'articles comportant le terme « set » incluent la table et le dessus de table correspondant.
Variations	We are not liable for variations in color, weight or dimensions, since such variations are typical of handmade furniture. Some of the fabrics shown in pictures of our furniture may be discontinued.
Abweichungen	Für Farben, Maße und Gewichte können wir keine Haftung übernehmen, da Abweichungen bedingt durch Handarbeit möglich sind. Manche Stoffe, die in unseren Abbildungen zu sehen sind, sind ggf. nicht mehr verfügbar.
Variaciones	No nos hacemos responsables de ninguna discordancia en cuanto al color, peso o tamaño, ya que las variaciones de este tipo son habituales en muebles fabricados a mano. Algunos de los tejidos de tapicería que aparecen en las fotografías podrían no estar disponibles.
Variazioni	Non ci assumiamo alcuna responsabilità per variazioni di colore, peso o dimensioni, poiché tali variazioni sono caratteristiche dei mobili realizzati a mano. Alcuni tessuti di rivestimento mostrati nelle immagini potrebbero essere fuori produzione.
Variations	Nous ne pouvons être tenus responsables des variations de couleur, de poids ou de dimensions, car des variations peuvent se produire dans des meubles fabriqués à la main. Quelques tissus de revêtement présentés sur nos images peuvent différer.
Volume	The stated volume does not include packaging.
Volumen	Das angegebene Volumen beinhaltet keine Verpackung.
Volumen	El volumen indicado no incluye el embalaje.
Volume	Il volume riportato non è comprensivo di imballaggio.
Volume	Le volume indiqué ne comprend pas l'emballage.
Weight	The stated weight of a furniture item does not include cushions and may vary according to fiber options. When multiple tabletops are available, a table's stated weight excludes the weight of the tabletop options, which are given separately.
Gewicht	Die Angaben zu dem Gewicht eines Möbelstücks verstehen sich exklusive Kissen und können aufgrund von unterschiedlichen Faserausführungen variieren. Stehen mehrere Tischplatten zur Auswahl, so sind die Angaben zu dem Gewicht des Tisches exklusive der Tischplatten. Das Gewicht der Tischplatten wird in diesem Fall separat aufgeführt.
Peso	El peso publicado de un artículo de muebles no incluye los cojines y puede variar de acuerdo a las fibras seleccionadas. Si hay disponibles diversos tableros de mesa, el peso dado de la mesa no incluye el peso de las opciones de tablero; este se ofrece aparte.
Peso	Il peso dei mobili indicato non include i cuscini e può variare a seconda del tipo di fibra. In caso siano disponibili più piani tavolo, il peso del tavolo non include il peso dei piani tavolo, il quale viene indicato separatamente.
Poids	Le poids indiqué pour un meuble ne comprend pas les coussins et peut varier selon la fibre choisie. Lorsque différents plateaux de table sont disponibles, le poids indiqué pour une table ne comprend pas celui du plateau choisi : celui-ci est indiqué séparément.

WARRANTY

5-YEAR WARRANTY	DEDON offers a five-year warranty against any manufacturing defects during normal use and maintenance. Valid for retail customers only, this warranty applies to all DEDON woven furniture that is manufactured solely from the DEDON fiber and aluminum frame. All other DEDON products are subject to a two-year warranty. This guarantee does not apply to faults or imperfections resulting from the passage of time or normal wear and tear. Circumstances not covered by this guarantee include, but are not limited to, the discoloration, fading or change in shade of colors, cracks, scratches or small chips in the paintwork arising from use, changes in wood texture, scratches resulting from use, or similar.
5 JAHRE GARANTIE	Für Endverbraucher wird eine fünfjährige Garantie gegen jegliche Fertigungsfehler bei normaler Verwendung und Pflege gewährt. Dies gilt für DEDON-Flechtmöbel, die ausschließlich aus der DEDON-Faser und aus Aluminiumrahmen hergestellt werden. Für alle weiteren DEDON-Produkte gelten 2 Jahre Gewährleistung. Von der Garantie oder Gewährleistung ausgeschlossen sind Fehler oder Unvollkommenheiten aufgrund des üblichen Verschleißes, wie beispielsweise Verfärben, Verblässen oder Veränderung der Farbtöne; Kratzer, Risse oder kleine Beschädigungen im Lack aufgrund des Gebrauchs; Veränderung der Holzstruktur; Kratzer durch Gebrauch und so weiter.
5 AÑOS DE GARANTÍA	DEDON ofrece una garantía de cinco años a los consumidores finales contra cualquier defecto de fabricación bajo condiciones de uso y conservación normales. Esto se aplica a los muebles tejidos de DEDON fabricados exclusivamente en fibras DEDON y bastidores de aluminio. Para todos los demás productos ofrecemos una garantía de dos años. Dicha garantía no cubre aquellos defectos o imperfecciones derivados del paso del tiempo o desgaste normal. Los casos no cubiertos por la garantía incluyen, entre otros, la decoloración o cambio de color, grietas, rasguños o pequeños trozos de pintura desconchada que deriven del uso, cambios en la textura de la madera, rasguños asociados con el uso o similares.
5 ANNI DI GARANZIA	DEDON offre una garanzia di 5 anni contro i difetti di fabbricazione, a fronte di corretto uso e manutenzione. La garanzia si applica ai mobili intrecciati DEDON realizzati esclusivamente con fibra DEDON e telaio in alluminio. A tutti gli altri prodotti DEDON si applica una garanzia di 2 anni. La presente garanzia non si applica a vizi o imperfezioni dovuti al trascorrere del tempo o alla normale usura. Le circostanze non coperte dalla presente garanzia includono, ma non si limitano a, scoloritura, sbiadimento o cambiamento di tonalità di colore, crepe, graffi o piccole scheggiature nella verniciatura, dovuti all'uso, ai cambiamenti nella texture del legno, o graffi dovuti all'uso, o simili.
5 ANS DE GARANTIE	DEDON propose une garantie de cinq ans contre tout défaut de production. Cette garantie est accordée dans le cadre d'une utilisation et d'un entretien normaux. Valable pour les particuliers uniquement, celle-ci s'applique à tous les meubles en tissu qui sont fabriqués exclusivement en fibre DEDON et avec un cadre en aluminium. Pour tous les autres produits DEDON, la garantie est de deux ans. Cette garantie ne s'applique pas aux défauts ou imperfections résultant du passage du temps ou de l'usure normale. Les circonstances non couvertes par cette garantie incluent, mais n'y sont pas limitées, la décoloration, l'atténuation, la modification des nuances de couleurs, des fissures, des rayures ou des petits éclats dans la peinture résultant de l'utilisation, des changements dans la texture du bois et des rayures résultant de l'utilisation ou similaire.

REAV



This item is available in two base configurations, for wind grade 3 (12-19 km/h) or wind grade 6 (39-49 km/h), the latter featuring additional steel weights. See icon for number of wind force.

Das Produkt ist mit zwei verschiedenen Ständervarianten erhältlich, die für Windstärke 3 (12-19 km/h) bzw. Windstärke 6 (39-49 km/h) geeignet sind; letztere Variante ist mit zusätzlichen Stahlgewichten ausgestattet. Die Windstärke ist mit einem Symbol angegeben.

Este producto está disponible en dos configuraciones posibles para la base: para una fuerza del viento 3 (12-19 km/h) o una fuerza del viento 6 (39-49 km/h). En el último caso, también cuenta con pesos de acero adicionales. Ver icono para encontrar el número de la fuerza del viento.

Questo articolo è disponibile in due configurazioni di base, per vento di grado 3 (12-19 km/h) o vento di grado 6 (39-49 km/h), quest'ultima con pesi aggiuntivi in acciaio. Vedi l'icona per il grado di forza eolica.

Le produit est disponible en deux variantes de support, pour une force de vent 3 (12-19 km/h) et pour une force de vent (39-49 km/h) ; cette dernière est munie de poids en acier supplémentaires. La force de vent est indiquée par un symbole.



FURNITURE

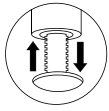

The furniture is fitted with sliding mechanisms for height adjustment.

Das Möbel ist mit höhenverstellbaren Gleitern ausgestattet.
El mueble lleva tapa-final regulable para ajustar la altura.
Mobile provvisto di piedini regolabili in altezza.
Le meuble est équipé de patins réglables en hauteur.



Includes a piece for securely connecting sections.

Inklusive Verbindungsstück "Connector" zur sicheren Verbindung einzelner Module.
Está incluido un "conector" para conectar los modules de forma seguro.
Include un 'connettore' per unire le varie sezioni in modo sicuro.
Comprend un "connecteur" pour relier les éléments de manière sécurisée.

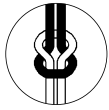

The cushions come equipped with a cushion holder to keep them from sliding.

Die Kissen werden mit einem Kissenhalter geliefert, damit sie nicht verrutschen können.
Los cojines vienen equipados con un soporte de fijación para evitar que se deslicen.
I cuscini sono dotati di un apposito supporto che impedisce loro di scivolare.
Un support de coussin est fourni avec chaque coussin pour les empêcher de glisser.

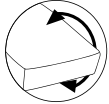

The seat cushion on this item may be flipped.

Das Sitzkissen dieses Möbels ist wendbar.
El cojín de este asiento es reversible.
Il cuscino della seduta di questo mobile è double face.
Le coussin de cet article est réversible.

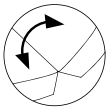

Foldable cushion comes with handles for easy carriage.

Das faltbare Sitzkissen wird mit zwei Schlaufen geliefert, um den Transport zu erleichtern.
El cojín plegable viene provisto de asas para facilitar su transporte.
Il cuscino ripiegabile è dotato di maniglie per un facile trasporto.
Pour faciliter le transport, un coussin pliable est livré avec deux poignées.

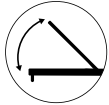

The backrest mechanism allows the stepless adjustment of your furniture thanks to a gas spring. Please review the instruction manual!

Der Mechanismus der Rückenlehne erlaubt aufgrund der Verwendung einer Gasdruckfeder das stufenlose Verstellen des Möbels. Bitte beachten Sie die mitgelieferte Gebrauchsanleitung!
El mecanismo del respaldo permite ajustar el mueble en progresión continua.
¡Por favor, tenga en cuenta las instrucciones de uso suministradas con el producto!
Il meccanismo permette un'inclinazione progressiva dello schienale.
Seguire le istruzioni incluse nel manuale!
Le mécanisme du dossier permet un réglage progressif du meuble grâce à un ressort à gaz.
Veuillez consulter le mode d'emploi fourni !

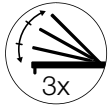

This item is available with a hook-catching mechanism. See icon for number of hooks.

Dieser Artikel ist mit Stufenverstellung erhältlich. Das Symbol zeigt jeweils die Anzahl der Stufen.
Este artículo dispone de un mecanismo de ajuste de altura. El icono muestra el número de ajustes.
Questo articolo è disponibile con un meccanismo di regolazione a ganci. Il simbolo indica il rispettivo numero di ganci.
Cet article est disponible avec un mécanisme de réglage du niveau d'inclinaison. Le pictogramme montre le nombre de niveaux.



The furniture is fitted with wheels.

Das Möbel ist mit Rollen ausgestattet.
El mueble lleva ruedas.
Mobile provvisto di ruote.
Le meuble est équipé de roulettes.



This item is stackable.

Das Möbel ist stapelbar.
Este artículo es apilable.
Questo articolo è impilabile.
Le meuble est empilable.



Rotatable by 360°.

Um 360° drehbar.
Gira 360°.
Ruota su se stesso di 360°.
Rotatif à 360°.



This item rocks.

Artikel mit Schaukelfunktion.
Este artículo se balancea.
Questo articolo dondola.
Le meuble se balance.

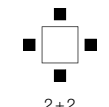

The recommended number of chairs is only for the collection represented and does not necessarily apply to chairs of another collection.

Die empfohlene Anzahl gilt allein für die Stühle dieser Kollektion und kann nicht auf kollektionsfremde Stühle übertragen werden.
El número recomendado sólo se aplica a las sillas de esta colección y no se puede trasladar a sillas de otras colecciones.
Il numero consigliato si riferisce unicamente alle sedie di questa collezione, non è valido per sedie di altre collezioni.
Le nombre recommandé ne vaut que pour les chaises de cette collection et ne peut pas être appliqué aux chaises d'autres collections.

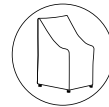

A protective cover is available for this item.

Für dieses Möbel ist eine schützende Husse erhältlich.
Existe la opción de una funda protectora para este mueble.
Per questi arredi è disponibile una housse di protezione.
Une housse de protection est disponible pour ce meuble.

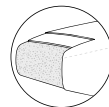

Dry+ cushion construction

Dry+ cushions are protected by a highly water-repellent interlayer rated to 10,000 mm.
Die Dry+ Kissen sind durch eine stark wasserabweisende innere Hülle mit einer Wassersäule von 10.000 mm geschützt.
Los cojines Dry+ están protegidos con un revestimiento muy impermeable con una resistencia al agua de nada menos que 10.000 mm.
I cuscini Dry+ sono protetti da uno strato interno con impermeabilità fino a 10.000 mm.
Les coussins Dry+ sont protégés par une couche intermédiaire hautement hydrofuge de 10 000 mm.

LIGHTING



The product is fitted with an LED lighting module.

Das Produkt ist mit einem LED Modul ausgestattet.
Este producto viene equipado con un módulo de iluminación LED.
Il prodotto è dotato di un modulo LED.
Ce produit comporte un module d'éclairage LED.



There are two ways of charging the LED module, by solar panel and by power adapter.

Zwei Optionen zum Aufladen des LED Moduls: Solarpanel oder Ladekabel.
Dos opciones para cargar el módulo LED: Panel solar o cable de carga.
Due opzioni per ricaricare il modulo LED: pannello solare o cavo elettrico.
Deux options pour charger le module LED : panneau solaire ou câble de chargement.



There is one way of charging the LED module by power adapter.

Das LED Modul wird mit einem Ladekabel aufgeladen.
El Módulo LED se carga solo a través del cable de carga.
Il modulo LED è caricabile tramite un adattatore di corrente.
Seul le câble de chargement permet de charger le module LED.

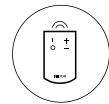

Remote Control: To switch on the light, use the remote control or the button on the bottom of the LED module.

Fernbedienung: Sie können entweder die Fernbedienung verwenden, um die Leuchten einzuschalten, oder die Taste an dem LED Modul.
Control remoto: Para encender las luces puede utilizar el control remoto o pulsar la tecla del módulo LED. Telecomando: Per accendere la luce potete usare il telecomando o il tasto sul modulo LED. Télécommande : Vous pouvez vous servir soit de la télécommande, soit de la touche située sur le module LED pour allumer les lampes.

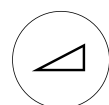

In addition to the on/off button, the remote control has a +/- function for adjusting the dimmer (8 steps).

Die Fernbedienung hat eine An- und eine Austaste, sowie eine + und eine - Taste für die Dimm-Funktion (8 Stufen).
El control remoto tiene un botón de encendido y de apagado y un botón de + y - para la función de atenuación.
Il telecomando ha un tasto di accensione e spegnimento (on/off) e un tasto + e un tasto - per variare l'intensità luminosa.
La télécommande comporte une touche Marche et une touche Arrêt, ainsi qu'une touche + et une touche - pour adapter l'intensité lumineuse.

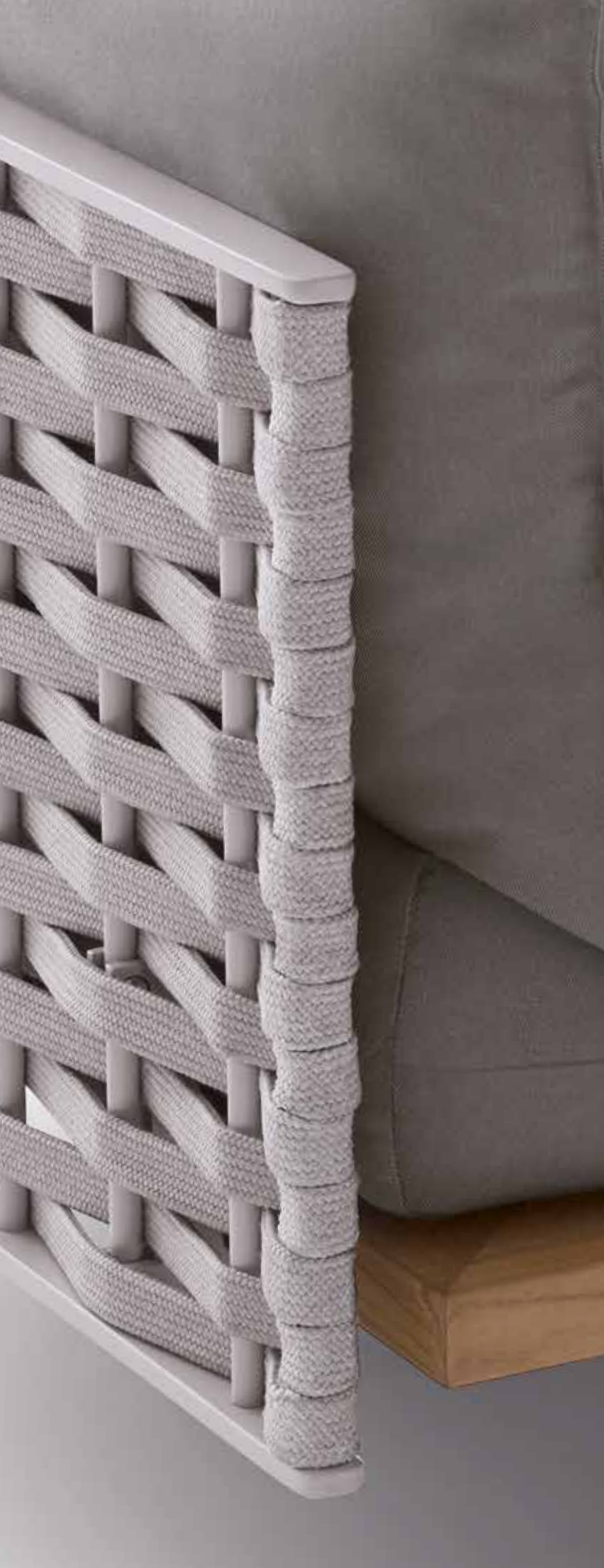

ROPE

EN ROPE

The traditional Italian maritime rope that DEDON uses for RILLY and SEALINE is a fresh interpretation of the brand's unique weaving heritage. Master colorist Giulio Ridolfo developed sophisticated yarn combinations for the rope, which is characterized by an appealing, textile touch.

Made of polypropylene yarns, with tenacity fillers for extra strength, the rope is weatherproof, non-absorbent and ideally suited for outdoor use. It offers excellent light fastness (grade 6), color fastness (against both chlorine and saltwater) and resistance to physical stress, UV radiation, mold and more. Stapled to the aluminum frame in the same way as DEDON Fiber, it is applied in short sections for easy repair. Wash at low temperature (30°C) with lukewarm water and a mild soap. To prevent dirt deposits, vacuum or lightly brush the rope regularly. Most dirt and stains can be cleaned if promptly treated.

DE SEIL

Das traditionelle maritime Seil aus Italien, das DEDON in den Kollektionen RILLY und SEALINE verwendet, ist eine erfrischende Neuinterpretation der einzigartigen Flechttradition der Marke. Der Farbdesigner Giulio Ridolfo hat die eleganten Garnkombinationen entwickelt, die für das Seil verwendet werden und ihm seine ansprechende textile Anmutung verleihen.

Das Seil besteht aus Polypropylen-Garnen mit Füllern für besonders hohe Zugfestigkeit. Es ist wetterfest, wasserabweisend und ideal für den Einsatz im Outdoor-Bereich geeignet – nicht zuletzt dank exzellenter Lichtechtheit (Grad 6), Farbechtheit (chlorwasser- und salzwasserbeständig) und seiner Widerstandsfähigkeit gegen physikalische Belastungen, UV-Strahlung, Schimmel und vieles mehr. Es wird, wie die DEDON-Faser, in kurzen Abschnitten auf den Aluminiumrahmen aufgebracht, was eventuelle Reparaturen vereinfacht. Mit lauwarmem Wasser (30°C) und einer milden Seife waschbar. Um Schmutzablagerungen zu verhindern, das Seil regelmäßig absaugen oder abbürsten. Die meisten Verschmutzungen oder Flecken lassen sich bei sofortiger Behandlung entfernen.

ES CUERDA

La cuerda náutica tradicional italiana que DEDON utiliza para RILLY y SEALINE es una nueva interpretación del inigualable patrimonio del tejido de la marca. El maestro colorista Giulio Ridolfo desarrolló sofisticadas combinaciones de hilo para la cuerda, la cual se caracteriza por su atractivo tacto, parecido al de un tejido.

Hecho con hilos de polipropileno y firmes rellenos para una mayor durabilidad, la cuerda es impermeable, no absorbente y totalmente apta para exteriores. Ofrece una gran resistencia a la luz (grado 6), colores perdurables (resistentes al cloro y al agua salada) y gran resistencia a la tensión física, a los rayos UVA, al moho y mucho más. Grapada al bastidor de aluminio de la misma forma que la fibra DEDON, la cuerda se aplica en fragmentos cortos para facilitar los trabajos de reparación. Limpiar a baja temperatura (30°C) con agua templada y jabón suave. Aspirar o cepillar suavemente la cuerda de vez en cuando para prevenir la acumulación de suciedad. La gran mayoría de suciedad y manchas pueden eliminarse si se tratan de inmediato.

IT CORDA

La tradizionale corda nautica italiana che DEDON utilizza per RILLY e SEALINE è una fresca interpretazione del patrimonio tessile unico di questo marchio. Il maestro colorista Giulio Ridolfo ha sviluppato per la corda una sofisticata combinazione di filati caratterizzata da un'affascinante qualità tessile.

Realizzata in filo di polipropilene, con filler per aumentarne resistenza e robustezza, la corda è impermeabile, non assorbente e perfettamente indicata per l'uso all'aperto. Offre eccellente resistenza alla luce (grado 6), resistenza del colore (al cloro e all'acqua salata) e resistenza a sollecitazioni fisiche, raggi UV, muffa e altri agenti esterni. Fissata al telaio in alluminio nello stesso modo della Fibra DEDON, la corda è applicata in segmenti corti per facilitarne l'eventuale riparazione. Lavare a bassa temperatura (30°C) con acqua tiepida e sapone delicato. Per prevenire l'accumulo di polvere, passare l'aspirapolvere sulla corda o spazzolarla con delicatezza con cadenza regolare. Quasi tutti i tipi di sporco e di macchie si possono rimuovere se trattati subito.

FR CORDE

La corde maritime italienne traditionnelle utilisée par DEDON pour les collections RILLY et SEALINE est une interprétation moderne de l'héritage du tissage unique en son genre de la marque. Le maître coloriste Giulio Ridolfo a développé des combinaisons de fils sophistiqués pour la corde, laquelle se distingue par un toucher textile attrayant.

Fabriquée à partir de fils de polypropylène, avec un revêtement résistant pour plus de solidité, la corde est imperméable, non absorbante et parfaitement adaptée à une utilisation en extérieur. Elle offre une excellente résistance à la lumière (classe 6), une résistance des couleurs (contre le chlore et l'eau salée), au stress physique, aux rayons UV, aux moisissures et plus encore. Accrochée au cadre en aluminium de la même manière que la fibre DEDON, elle est appliquée en sections courtes pour une réparation facile. À nettoyer à basse température (30°C) à l'eau tiède avec un savon doux. Afin d'éviter les dépôts d'impuretés, passez la corde à l'aspirateur ou brossez-la légèrement régulièrement. La plupart des impuretés et des taches peuvent être nettoyées si elles sont traitées rapidement.



FIBER

EN DEDON FIBER

Researched, developed, manufactured and quality-tested at our production facilities in Northern Germany, DEDON fiber (HDPE) is unrivaled for its durability, weather-fastness and of luxuriousness of color, texture and touch. Strong enough to withstand the harshest conditions yet supple enough to be woven into artful patterns by our master weavers, it has revolutionized outdoor furniture.

Because DEDON produces its fiber entirely in house, we are able to work with our world-renowned designers to develop unique colors, textures and profiles. Our specialists monitor every new fiber we create, checking for resistance to UV-rays, salt water, pool water and extremes of temperature. The final product is non-toxic, non-polluting and fully recyclable. It is maintenance-free, easy to clean and recommended for indoor and outdoor use.

DE DIE DEDON-FASER

Die DEDON-Faser (HDPE) wird in unseren hochmodernen Produktionsstätten in Norddeutschland erforscht, entwickelt, hergestellt und auf ihre Qualität getestet. Sie ist konkurrenzlos in ihrer Strapazierfähigkeit und Wetterfestigkeit und zeichnet sich durch luxuriöse Farben, feine Textur und besondere Haptik aus. Die Faser hat den Bereich Outdoor-Möbel revolutioniert, denn sie ist stark genug, den härtesten Bedingungen zu trotzen und gleichzeitig so biegsam, dass unsere Flechtkünstler kunstvolle Muster aus ihr fertigen können.

Dadurch, dass wir bei DEDON unsere Fasern komplett im eigenen Hause fertigen lassen, können wir gemeinsam mit unseren Designern von Weltruf Fasern mit einzigartigen Farben, Oberflächen und Faserprofilen entwickeln.

Jede neu entwickelte Faser wird von unseren Experten auf ihre Beständigkeit gegen UV-Strahlung, Salz- und Chlorwasser sowie extreme Temperaturen geprüft. Das fertige Produkt ist schadstofffrei, umweltfreundlich sowie voll recycelbar, wartungsfrei, leicht zu reinigen sowie für den Einsatz im Innen- und Außenbereich geeignet.

ES FIBRA DEDON

Investigada, desarrollada, fabricada y de calidad probada en nuestras instalaciones de producción del norte de Alemania. La fibra DEDON (HDPE) es inigualable por su durabilidad y resistencia a las condiciones climáticas, así como por el lujo de colores, texturas y tactos. Lo suficientemente fuerte para resistir a las condiciones más duras, pero lo bastante flexible para ser trenzada por nuestros maestros tejedores, que crean artísticos patrones, esta fibra ha revolucionado el mobiliario de exterior.

DEDON fabrica sus fibras en sus instalaciones, por lo que somos capaces de trabajar con nuestros diseñadores de renombre internacional para desarrollar colores, texturas y perfiles únicos. Nuestros especialistas supervisan cada nueva fibra que creamos, comprobando su resistencia a los rayos UV, al agua salobre, al agua de piscina y a las temperaturas extremas. El producto final no contiene sustancias nocivas, no es contaminante y es totalmente reciclable. No requiere mantenimiento, es fácil de limpiar y es recomendable para utilizar tanto en exteriores como en interiores.

IT LA FIBRA DEDON

Studiata, sviluppata, prodotta e sottoposta a test di qualità nei nostri stabilimenti di produzione con sede nella Germania del nord, la fibra DEDON (in HDPE) non teme confronti in quanto a durata, resistenza alle intemperie, ricchezza di colori, tessuti, piacevolezza al tatto. Robusta a sufficienza per resistere alle condizioni atmosferiche più rigorose, ma abbastanza soffice da poter essere intrecciata in motivi artistici dai nostri mastri tessitori, la fibra ha rivoluzionato l'arredamento outdoor.

Grazie al fatto che l'intera produzione della fibra DEDON avviene nei nostri stabilimenti, siamo in grado di lavorare insieme a designer di fama internazionale per sviluppare colori, tessuti e profili che riflettano l'anima delle loro collezioni. I nostri specialisti controllano ogni nuova fibra che creiamo, verificandone la resistenza ai raggi UV, all'acqua salata, all'acqua clorata e alle temperature estreme. Il prodotto che ne risulta è atossico, non inquina ed è completamente riciclabile. Non richiede manutenzione, è facile da pulire e ideale da usare sia in ambienti interni che esterni."

FR FIBRE DEDON

Étudiée, développée, fabriquée et testée dans nos sites de production du nord de l'Allemagne, la fibre DEDON (HDPE) possède une solidité et une résistance aux intempéries inégalées et se démarque de ses concurrents par des couleurs luxueuses, une texture délicate et une agréable sensation au toucher. Suffisamment solide pour résister aux conditions les plus extrêmes et pourtant tellement souple pour le tissage d'élégants modèles par nos maîtres-tisserands, la fibre a révolutionné l'univers du mobilier d'extérieur.

La production exclusivement interne de notre fibre DEDON nous permet de collaborer avec des designers connus dans le monde entier pour concevoir et développer des couleurs, des textures et des profils uniques. Nos experts examinent chaque nouvelle fibre élaborée, vérifiant la résistance aux rayons ultraviolets, à l'eau salée et chlorée et aux températures extrêmes. Le produit fini est non toxique, non polluant et entièrement recyclable. Il ne nécessite en outre aucun entretien, est facile à nettoyer et est recommandé pour l'intérieur et l'extérieur.

TABLETOPS

EN THE FINISHING TOUCHES FOR YOUR TABLE

From glass to teak, aluminum to HPL, DEDON offers a wide range of tabletop materials. These innovative solutions not only integrate with the design concepts of the various collections but also meet the top-quality standards DEDON insists upon for all of its outdoor furniture.

- **SINGLE-LAYER TEMPERED GLASS**

Offers increased resistance to temperature changes as well as excellent resistance to bending, impact and shock. To clean a glass tabletop, use a soft cloth, warm water and a gentle cleanser if needed.

- **HIGH PRESSURE LAMINATE (HPL)**

A non-toxic material that is highly resistant to impact, mechanical stress, moisture and steam. To clean an HPL tabletop, use a soft cloth, warm water and a gentle cleanser if needed.

- **POWDER COATED METAL**

The metal sheets are covered with a highly resistant powder coating, giving the tabletop unbeatable durability and outdoor performance. Clean with a soft cloth and warm water.

- **NATURAL-FINISH TEAK**

Consisting of beautiful premium teak sourced from sustainable plantations, the tabletop is rich with natural tannin oils, offering great durability in extreme weather conditions. Wash using warm water in which natural soap flakes have been dissolved.

- **MINERAL COMPOSITE**

These innovative, long-lasting mineral-composite tabletops are waterproof, extremely hygienic and highly resistant to frost, UV-rays and abrasion. Clean with soft cloth and warm water.

- **CERAMIC**

The tabletop is made of Monolite Ipergres®, a frost-proof ceramic that is non-absorbing and highly resistant to impacts, scratches and abrasion. Clean with a soft cloth and warm water.

- **NATURAL STONE**

Tabletops in natural stone, including our Belgian pierre blue stone, are moisture-proof, quick-drying and resistant to weather, dirt and pollution. Please consult care instructions.

Watch out: Dark tabletops may become very hot when exposed to strong sunlight.

DE DER LETZTE SCHLIFF FÜR IHREN TISCH

Ob Glas, Teak, Aluminium oder HPL: DEDON bietet eine große Palette verschiedener Materialien für Tischplatten. Diese innovativen Werkstoffe passen nicht nur genau zum jeweiligen Designkonzept der verschiedenen Kollektionen, sie erfüllen auch die höchsten Qualitätsansprüche, die DEDON bei der Verwendung für Gartenmöbel fordert.

- **GLAS**

Das Einscheiben-Sicherheitsglas verfügt über eine verbesserte Temperaturwechselbeständigkeit und weist eine sehr gute Biege-, Schlag- und Stoßfestigkeit auf. Zur Reinigung der Tischplatte eignen sich ein weiches Tuch, warmes Wasser und bei Bedarf ein sanftes Reinigungsmittel.

- **HIGH-PRESSURE-LAMINATE (HPL)**

HPL ist ein ungiftiges Material, das sich durch hohe Stoßfestigkeit und extreme Widerstandskraft gegen mechanische Einwirkungen, Feuchtigkeit und Dampf auszeichnet. Zur Reinigung der Tischplatte eignen sich ein weiches Tuch, warmes Wasser und bei Bedarf ein sanftes Reinigungsmittel.

- **PULVERBESCHICHTETES METALL**

Die Metallplatten sind mit einer hochresistenten Pulverbeschichtung versehen. Diese Tischplatten zeichnen sich durch besondere Haltbarkeit und Wetterfestigkeit aus. Einfach mit einem weichen Tuch und warmem Wasser zu reinigen.

- **NATURBELASSENES TEAK**

Tischplatten aus diesem Premium Teak von nachhaltig bewirtschafteten Plantagen, das reich an natürlichen Tanninen ist, verfügen auch unter extremen Wetterbedingungen über eine äußerst lange Lebensdauer. Reinigen Sie das Holz mit lauwarmem Wasser unter Hinzugabe von materialschonender Naturseife.

- **MINERAL KOMPOSITWERKSTOFF**

Die innovativen, haltbaren Tischplatten aus Mineralkompositwerkstoff sind wasserfest, extrem hygienisch und hochgradig frost-, UV- und abriebresistent. Einfach mit einem weichen Tuch und warmem Wasser zu reinigen.

- **KERAMIK**

Die Tischplatte besteht aus Monolite Ipergres®, einem frostsicheren, nicht-absorbierendem Keramikmaterial, das extrem resistent gegen Stöße, Kratzer und Abrieb ist. Einfach mit einem weichen Tuch und warmem Wasser zu reinigen.

- **NATURSTEIN**

Tischplatten aus Naturstein, einschließlich unseres belgischen Natursteins im Farbton Pierre Blue, sind feuchtigkeitsbeständig, schnelltrocknend und widerstandsfähig gegen Wittereinflüsse, Staub und Schmutz. Bitte Pflegehinweise beachten.

Achtung: Dunkle Tischplatten können sich im Sonnenlicht sehr stark aufheizen.

ES LOS ÚLTIMOS RETOQUES PARA SU MESA

Si cristal, teca, aluminio o madera contrachapada termoformada al vapor (HPL), DEDON ofrece una amplia gama de materiales para tablas de mesa. Estos materiales innovadores no solamente se integran bien en los conceptos de las más variadas colecciones, sino que además cumplen con los más altos requisitos de calidad de DEDON para su utilización en mobiliario de exterior.

- **CRISTAL**

El cristal de seguridad monocapa aumenta la resistencia a los cambios de temperatura y ofrece una excelente resistencia a la flexión, impacto y los golpes. Para limpiar los tableros de las mesas, utilice un paño suave y agua caliente y, si es necesario, un limpiador suave.

- **HPL**

Laminado de alta presión (HPL) es un material no tóxico altamente resistente al impacto, estrés mecánico, humedad y vapor. Para limpiar los tableros de las mesas, utilice un paño suave y agua caliente y, si es necesario, un limpiador suave.

- **METAL RECUBIERTO EN POLVO**

Las láminas de metal están recubiertas de una capa en polvo altamente resistente que ofrece a la mesa un rendimiento y una durabilidad incomparables en espacios exteriores. Limpiar con un paño suave y agua tibia.

- **TECA NATURAL**

Esta maravillosa madera teca de calidad superior y de lento crecimiento, obtenida de plantaciones sostenibles y rica en aceites naturales de taninos, ofrece una gran durabilidad en condiciones meteorológicas extremas. Lavar con agua templada y jabón natural en copos bien disueltos.

- **COMPUESTO MINERAL**

Estos innovadores y duraderos tableros elaborados con compuesto mineral son impermeables, extremadamente higiénicos y resistentes a las heladas, los rayos UVA y la abrasión. Limpiar con un paño suave y agua tibia.

- **CERÁMICA**

El tablero está elaborado con Monolite Ipergres®, una cerámica a prueba de heladas, no absorbente y altamente resistente a los golpes, rasguños y rozaduras. Limpiar con un paño suave y agua tibia.

- **PIEDRA NATURAL**

Los tableros de piedra natural, incluida la piedra belga pierre blue, son a prueba de humedad, secan rápidamente y son resistentes a la intemperie, la suciedad y la contaminación. Por favor, lea las instrucciones de mantenimiento.

Atención: Los tableros oscuros pueden calentarse mucho al estar expuestos luz solar intensa.

IT IL TOCCO FINALE PER IL VOSTRO TAVOLO

Dal vetro al teak, dall' alluminio all' HPL, DEDON offre un'ampia gamma di materiali diversi per i piani dei tavoli. Questi materiali innovativi non solo si adattano perfettamente al design delle varie collezioni, ma soddisfano anche i massimi requisiti qualitativi richiesti da DEDON per i suoi mobili da esterno.

- **VETRO**

Il vetro di sicurezza monostrato offre una maggiore resistenza alle variazioni di temperatura e una resistenza eccellente alla flessione, agli impatti e agli urti. Per pulire i piani usare un panno soffice, acqua calda e, se necessario, un detergente delicato.

- **HPL**

Il laminato ad alta pressione (HPL) è un materiale non tossico estremamente resistente agli impatti, alle sollecitazioni meccaniche, all'umidità e al vapore. Per pulire i piani usare un panno soffice, acqua calda e, se necessario, un detergente delicato.

- **METALLO VERNICIATO A POLVERE**

Le lamine metalliche sono rivestite da una verniciatura a polvere altamente resistente che conferisce al piano del tavolo eccezionale durezza ed estrema resistenza in ambienti esterni. Pulire con un panno morbido e acqua tiepida.

- **TEAK NATURALE NON TRATTATO**

Il piano del tavolo in teak è prodotto con un legno di ottima qualità proveniente da piantagioni sostenibili. Questo bellissimo legno a lenta crescita è ricco di oli naturali di tannino ed offre un'ottima resistenza a condizioni meteorologiche estreme. Lavare con acqua tiepida in cui siano stati dissolti fiocchi di sapone naturale.

- **COMPOSITO MINERALE**

Questi innovativi e durevoli piani dei tavoli in composito minerale sono impermeabili, estremamente igienici e altamente resistenti al gelo, ai raggi UV e all'abrasione. Pulire con un panno morbido e acqua calda.

- **CERAMICA**

Il piano del tavolo è realizzato in Monolite Ipergres®, una ceramica resistente al gelo che è non assorbente e altamente resistente a urti, graffi e abrasione. Pulire con un panno morbido e acqua calda.



- **PIETRA NATURALE**

I piani dei tavoli in pietra naturale, inclusa la nostra pietra belga pierre blue, sono idrorepellenti, ad asciugatura rapida e resistenti agli agenti atmosferici, allo sporco e all'inquinamento. Si prega di consultare le istruzioni per la manutenzione.

Attenzione: i piani dei tavoli scuri possono surriscaldarsi quando esposti a forte e diretta luce solare.

FR LA TOUCHE FINALE POUR VOTRE TABLE

Du verre au teck, de l'aluminium au HPL – DEDON propose une large gamme de matériaux pour les plateaux de table. Non seulement ces matériaux innovants s'inscrivent parfaitement dans le design des différentes collections, mais ils satisfont aussi aux plus hautes exigences de qualité imposées par DEDON pour ses meubles d'extérieur.

- **VERRE**

Le verre de sécurité monocouche offre une résistance accrue aux changements de température ainsi qu'une excellente résistance à la flexion, aux impacts et aux chocs. Pour nettoyer les plateaux de table, utilisez un chiffon doux et de l'eau chaude et, si nécessaire, un détergent léger.

- **HPL**

Le stratifié HPL (High Press Laminate) est un matériau non toxique, hautement résistant aux impacts, aux contraintes mécaniques, à l'humidité et à la vapeur d'eau. Pour nettoyer les plateaux de table, utilisez un chiffon doux et de l'eau chaude et, si nécessaire, un détergent léger.

- **MÉTAL THERMOLAQUÉ**

Les plaques en métal sont dotées d'un revêtement thermolaqué hautement résistant. Ces plateaux de table se distinguent par une durée de vie particulièrement longue et une résistance aux intempéries. Nettoyer avec un chiffon doux et de l'eau chaude.

- **TECK À TEINTE NATURELLE**

Ce magnifique bois précieux à croissance lente, riche en tanins naturels est particulièrement résistant aux conditions climatiques extrêmes. Nettoyer le plateau en teck avec du savon naturel en paillettes dilué dans de l'eau chaude.

- **MINÉRAL COMPOSITE**

Ces plateaux de table innovants et durables en composite minéral sont étanches, extrêmement hygiéniques et très résistants au gel, aux rayons UV et à l'abrasion. Nettoyer avec un chiffon doux et de l'eau chaude.

- **CÉRAMIQUE**

Le plateau de la table est conçu en Monolite Ipergres®, un matériau céramique résistant au gel, non absorbant et hautement résistant aux impacts, aux rayures et à l'abrasion. Nettoyer avec un chiffon doux et de l'eau chaude.

- **PIERRE NATURELLE**

Les plateaux de table en pierre naturelle, y compris dans le coloris 'Belgian pierre blue', séchent vite, sont résistants aux moisissures, aux intempéries, aux impuretés et à la pollution. Veuillez respecter les consignes d'entretien.

Attention : les plateaux de table foncés peuvent devenir brûlants lorsqu'ils sont exposés à une forte lumière du soleil.

TEAK

EN THE BEAUTY OF TEAK

Teak is one of the world's most valuable timber resources. Furniture made from this beautiful premium teak, sourced from sustainable plantations, is rich in natural tannins and is able to withstand even extreme weather conditions over an exceptionally long lifetime. The wood is resistant to rain, strong sunlight, freezing conditions and fluctuating temperatures. These qualities make it particularly well-suited to longterm outdoor use.

Made using only exclusively from premium teak, DEDON teak furniture requires no special maintenance besides other than periodic cleaning. If allowed to age naturally outdoors, it will eventually turn to a soft, silver-gray as surface pigments fade. As this is a natural process, the silver-gray color may appear irregularly, especially at first.

To retain the wood's original, golden hue, use DEDON teak oil at least twice a year. To clean it, use a DEDON cleaning agent once or twice a year. To remove any raised grain and restore the surface to a smooth finish, lightly sand from time to time.

Allow your teak furniture with cushions to dry before using covers. To prevent mold and stains, DEDON recommends not to use covers for tables with teak tabletops.

For further information on DEDON care products, please visit www.dedon.de.

DE DIE SCHÖNHEIT VON TEAK

Teakholz gehört zu den wertvollsten Nutzhölzern der Welt. Möbel aus diesem schönen Premium-Teak aus nachhaltig bewirtschafteten Plantagen, das reich an natürlichen Tanninen ist, verfügen auch unter extremen Wetterbedingungen über eine äußerst lange Lebensdauer. Das Holz widersteht Nässe, extremer Sonneneinstrahlung und Kälte sowie Temperaturschwankungen. Es ist daher zum Dauereinsatz im Freien besonders geeignet.

DEDON-Teakmöbel bedürfen neben einer gelegentlichen Reinigung keiner besonderen Pflege. Setzt man Teak auf natürliche Weise dem Wetter aus, verändert sich seine goldene Farbe und wird zu einem weichen Silbergrau. Da es sich hierbei um einen natürlichen Alterungsprozess handelt, kann das Silbergrau besonders anfangs noch etwas ungleichmäßig erscheinen.

Wünschen Sie einen Erhalt des goldenen Farbtons, streichen Sie mindestens zweimal jährlich das Teak mit DEDON-Teaköl ein. Reinigen Sie das Holz ein- oder zweimal im Jahr mit DEDON-Reinigungsmittel. Teakmöbel können auch von Zeit zu Zeit leicht abgeschliffen werden, um raue Maserungen zu entfernen und die Oberfläche wieder zu glätten.

Stellen Sie sicher, dass die Teakmöbel mit Kissen vollständig trocken sind, bevor Sie sie abdecken. Wir raten Ihnen die Tische mit Teakoberfläche nicht mit Hussen abzudecken, um Schimmelbildung auf der Tischplatte vorzubeugen.

Für weitere Informationen zu DEDON-Pflegeprodukten, besuchen Sie unsere Webseite: www.dedon.de.

ES LA BELLEZA DE LA TECA

La madera de teca es una de las maderas útiles más valiosas del mundo. El mobiliario compuesto por esta bonita teca premium, proviene de plantaciones sostenibles, rica en tanino natural, tiene una vida útil extraordinariamente larga incluso en condiciones meteorológicas extremas. La madera es resistente a la humedad, a la radiación solar extrema, al frío y a cambios de temperatura. Por eso, es idónea para el uso permanente al aire libre.

Además de una limpieza periódica, los muebles de teca DEDON no requieren un mantenimiento especial. Si se somete a la teca a condiciones meteorológicas naturales, su color dorado se volverá en un gris plateado uniforme. Puesto que se trata de un proceso natural, el gris plateado podría aparecer de forma irregular, especialmente al principio.

Si se desea conservar su color dorado original, unte la teca al menos dos veces al año con aceite para teca DEDON. Limpie la madera una o dos veces al año con productos de limpieza DEDON. Los muebles de teca se pueden lijar de vez en cuando para eliminar vetas ásperas y restaurar el acabado liso de la superficie.

Deje que sus muebles de teca con cojines se sequen antes de usar las fundas. DEDON no recomienda el uso de fundas en mesas con tablero de teca para evitar el moho y las manchas.

Para obtener más información sobre los productos de cuidado de DEDON, visite nuestra página web: www.dedon.de

IT LA BELLEZZA DEL TEAK

Il teak è uno dei legni più preziosi al mondo. I mobili realizzati con questo teak di prima qualità, proveniente da piantagioni sostenibili e naturalmente ricco di oli di tannino, offrono un'eccellente durata nel tempo, anche in condizioni atmosferiche estreme. Il legno resiste all'umidità, all'intensa luce solare, al freddo, e agli sbalzi di temperatura. È dunque particolarmente adatto all'utilizzo prolungato all'aria aperta.

I mobili in teak di DEDON non necessitano di una particolare manutenzione oltre alla loro pulizia periodica. Esponendo il teak agli agenti atmosferici in modo naturale, la pigmentazione si dissolve rivelando col tempo una tenue tonalità grigio argento. Trattandosi di un processo naturale, il colore grigio argento potrà apparire in maniera irregolare, specialmente in fase iniziale.

Per conservare la tonalità dorata originale, il teak va trattato con l'olio per teak di DEDON una o due volte l'anno. Una leggera levigatura occasionale dei mobili in teak è suggerita per eliminare le venature ruvide e per mantenere la superficie liscia.

Assicurarsi che mobili e cuscini siano completamente asciutti prima di utilizzare le coperture. DEDON non consiglia l'utilizzo di coperture per i tavoli con piano in teak al fine di evitare muffe e macchie.

Per ulteriori informazioni sui prodotti per la pulizia di DEDON, visitate il nostro sito: www.dedon.de.

FR LA BEAUTÉ DU TECK

Le teck est l'un des bois les plus précieux au monde. Les meubles fabriqués dans ce beau teck haut de gamme, cultivé dans des plantations à exploitation durable et naturellement riche en tanins, ont une longue durée de vie, même dans des conditions météorologiques extrêmes. Le bois résiste à l'humidité, au rayonnement solaire, au froid extrême, ainsi qu'aux variations de température. Il est donc très bien adapté à une utilisation extérieure permanente.

Les meubles en teck DEDON ne nécessitent aucun entretien particulier, excepté un nettoyage occasionnel. Exposée aux aléas météorologiques, la couleur dorée du teck laisse place à un gris argenté homogène. Étant donné qu'il s'agit d'un processus naturel, la couleur gris argenté peut apparaître irrégulièrement, surtout au début.

Si vous souhaitez conserver la teinte dorée originale du bois, enduisez au moins deux fois par an le teck d'huile spécifique pour teck DEDON. Nettoyez le bois une ou deux fois par an avec un produit nettoyant DEDON. Les meubles en teck peuvent également être légèrement poncés de temps en temps afin de supprimer les grains du bois rugueux : leur surface sera de nouveau lisse et agréable au toucher.

Assurez-vous que vos meubles en teck et leurs coussins sont bien secs avant l'utilisation des housses. DEDON ne recommande pas l'usage de housses pour les tables avec un plateau en teck, afin d'éviter la moisissure et les taches.

Vous trouverez de plus amples informations quant aux produits d'entretien DEDON sur notre site Internet: www.dedon.de.



Natural teak



Weathered teak



COVER

EN DEDON COVERS – HANDLING AND CARE

DEDON furniture covers are made of Weathermax®, a heavy-duty, 100%-solution-dyed polyester fabric. Weathermax® is water-resistant and UV-resistant, with outstanding breathability and durability. Because of their superior breathability, DEDON covers minimize dampness, heat build-up and condensation, helping to prevent mold and mildew from forming on your furniture.

Tailored to fit perfectly over their corresponding products, DEDON covers feature zippers for easy draping as well as elastic straps and loops (product-specific) for securing them in windy conditions. Clean covers with warm water and a gentle upholstery cleaner. Before storing, allow them to dry by hanging them using the featured strap (not part of all covers). Do not bleach or iron.

All cushions should be dry before applying DEDON covers. For longer periods, e.g. during wintertime, we recommend storing your cushions in a dry place indoors.

DE DEDON HUSSEN – HANDHABUNG UND PFLEGE

Die DEDON-Hussen bestehen aus dem Stoff Weathermax®, einem zu 100% in Masse gefärbten, extrem strapazierfähigen Polyester. Weathermax® ist sowohl resistent gegen UV-Strahlung als auch wasserabweisend, luftdurchlässig und langlebig. Die Luftdurchlässigkeit des Materials ist zur Reduzierung von Feuchtigkeit, Wärmeentwicklung und Kondensation sehr wichtig. Das wiederum beugt Schimmelbildung auf oder in den Möbeln vor.

Die Hussen wurden den Maßen Ihres Möbelstückes genau angepasst. Sie sind—je nach Produkt—mit Reißverschlüssen, elastischen Nähten und Schlaufen ausgestattet, damit sie einfach über dem Möbel platziert und bei Wind festgezurt werden können. Reinigen Sie die Hussen mit einem weichen Tuch und warmem Wasser. Wenn nötig, verwenden Sie einen schonenden Polsterreiniger. Nicht bleichen, nicht bügeln.

Stellen Sie sicher, dass sowohl die Möbel als auch die Kissen vollständig trocken sind, bevor Sie sie abdecken. Für die dauerhafte Lagerung (beispielsweise während der Wintermonate) raten wir Ihnen die Kissen im Innenraum aufzubewahren.

ES FUNDAS DEDON – USO Y MANTENIMIENTO

Las fundas DEDON están fabricadas con Weathermax®, un tejido 100% de poliéster teñido de alta resistencia. Weathermax® es un material hidrófugo y resistente a los rayos UV, con una excelente transpiración y durabilidad. Gracias a su gran transpiración, las fundas DEDON reducen la formación de humedad, la acumulación de calor y la condensación, ayudando a prevenir la formación de moho en los muebles.

Adaptadas para encajar perfectamente en los productos correspondientes, las fundas DEDON incluyen cremallera, cintas elásticas y cierres (específicos para cada producto) para asegurarlas cuando hace viento. Lavar las fundas con agua tibia y un limpiador suave para tapicería. Antes de guardarlas, colgarlas para que se sequen usando las cintas (no incluidas en todas las fundas). No usar lejía ni planchar.

Los cojines deben estar secos antes de poner las fundas DEDON. Para periodos largos, como por ejemplo durante el invierno, recomendamos guardar los cojines en un lugar interior seco.

IT HOUSSES DEDON – IMPIEGO

Le fodere DEDON sono in Weathermax®, un tessuto di poliestere 100% tinto in massa, estremamente resistente. Weathermax® è resistente sia ai raggi UV, sia all'acqua, è traspirante e durevole. La traspirabilità del materiale è molto importante per ridurre l'umidità, la formazione di calore e la condensa, prevenendo la formazione di muffa sui vostri mobili.

Le fodere sono state realizzate a misura per rivestire perfettamente i vostri mobili. Sono dotate – a seconda del prodotto – di chiusure a strappo, cuciture elasticizzate e occhielli, grazie ai quali si può rivestire il mobile con facilità e avere un fissaggio sicuro quando soffia il vento. Pulire le fodere con un panno morbido e acqua calda, utilizzando, se necessario, un detergente delicato per imbottiti. Non candeggiare, non stirare.

Assicurarsi che sia i mobili, sia i cuscini siano completamente asciutti prima di coprirli con le federe. Per lo stoccaggio prolungato (ad esempio nei mesi invernali) si consiglia inoltre di riporre i cuscini in ambiente chiuso.

FR HOUSSES DEDON – MANIEMENT ET ENTRETIEN

Les housses pour les meubles DEDON sont fabriquées en Weathermax®, un tissu robuste, 100% polyester teinté dans la masse. Weathermax® résiste à l'eau, aux rayons UV et est incroyablement durable et respirable. Grâce à leur respirabilité supérieure, les housses DEDON réduisent l'humidité, l'accumulation de chaleur et la condensation, empêchant ainsi la formation de moisissure sur vos meubles.

Conçues pour s'adapter parfaitement aux produits leur correspondant, les housses DEDON comprennent une fermeture Éclair pour faciliter leur mise en place, ainsi que des bandes et des boucles élastiques (en fonction du produit) pour les fixer en cas de vent. Nettoyez les housses avec de l'eau chaude et un nettoyant pour tissus doux. Avant de les ranger, laissez sécher les housses en les accrochant par la bande prévue à cet effet (disponible que pour certains modèles). Ne pas utiliser d'eau de Javel sur les housses ni les repasser.

Assurez-vous que les coussins sont bien secs avant d'utiliser les housses DEDON. Pour les périodes prolongées, par exemple durant l'hiver, nous recommandons de conserver vos coussins à l'intérieur et au sec.





CUSHIONS & FABRICS

EN CUSHIONS YOU CAN LEAVE OUTDOORS

DEDON relies on some of the world's most advanced textile technologies to create cushions you can leave outside. Our high-quality acrylic materials are UV-resistant and specially treated to make them splash-resistant, with no loss of comfort. The foam cores, created exclusively for DEDON, and synthetic fiber padding are surrounded by a water-repellent, breathable, spun-bonded wrap. After a shower of rain, allow your cushions to dry so as to protect them from mold stains. We recommend storing your cushions for the winter or when not in use for long periods, and using covers to keep them at their best. Before storing, make sure they are completely dry. Our materials meet the highest standards of quality for outdoor usage. All fabrics are quick-drying and easy to maintain.

TEN FABRIC STYLES TO PLAY WITH

Each of the ten fabric styles in this catalog has a distinctive weaving structure that gives it a look and feel all its own. While any one of these fabrics is an ideal covering for cushions large or small, it's the opportunity to combine them that makes the DEDON collection so special. Play with textures. Mix the summery lightness of COOL with the tweedy robustness of GLAN. Create subtle differences of shade by working with multiple fabric structures in the same color. The flexibility and creativity long associated with the finest indoor fabrics can now be enjoyed under the open skies.

DE KISSEN, DIE DRAUSSEN BLEIBEN KÖNNEN

DEDON setzt die weltweit modernsten Textiltechnik-Verfahren ein, damit Ihre Kissen auch mal draußen bleiben können. Dank einer speziellen Behandlung sind unsere hochwertigen Acrylmateriale spritzwassergeschützt – ohne sich deshalb weniger komfortabel anzufühlen. Darüber hinaus sind sie beständig gegen UV-Strahlen. Der speziell für DEDON hergestellte Schaumstoffkern und die Kunstfaserpulverung werden durch einen wasserabweisenden und gleichzeitig atmungsaktiven Spinnvliesstoff umhüllt. Lassen Sie Ihre Kissen nach einem Regenschauer trocknen, um sie vor Stockflecken zu schützen.

Verstauen Sie Ihre Kissen im Winter oder wenn Sie sie über längere Zeit nicht nutzen. Am schönsten bleiben die Kissen, wenn Sie sie mit DEDON-Hussen abdecken. Stellen Sie vor dem Verstauen und Abdecken sicher, dass die Kissen vollständig trocken sind. Unsere Materialien entsprechen den höchsten Qualitätsstandards für die Nutzung im Freien. Sämtliche Materialien sind schnelltrocknend und pflegeleicht.

ZEHN STOFFVARIATIONEN BIETEN ABWECHSLUNG

Jede der zehn Stoffvarianten in diesem Katalog hat ihre eigene unvergleichliche Webstruktur und damit einen ganz einzigartigen Look & Feel. Während sich jeder unserer Stoffe perfekt als Bezug für unsere Kissen eignet, egal ob klein oder groß, sind es insbesondere die vielfältigen Kombinationsmöglichkeiten der Stoffe untereinander, die die DEDON-Stoffkollektion so attraktiv machen. Spielen Sie mit den Texturen, etwa indem Sie die sommerliche Frische von COOL mit der Robustheit von GLAN kombinieren, die an Tweed-Stoffe erinnert. Schaffen Sie subtile Farbnuancen, indem Sie mit unterschiedlichen Strukturen in der gleichen Farbwelt arbeiten. Freuen Sie sich, dass Sie unter freiem Himmel ebenso abwechslungsreich und kreativ sein können, wie Sie es von den feinsten Indoor-Stoffen gewohnt sind.

ES COJINES QUE PUEDES DEJAR EN EL EXTERIOR

DEDON se basa de las tecnologías textiles más avanzadas del mundo para crear cojines que pueda dejar en el exterior. Nuestros materiales acrílicos de alta calidad están especialmente recubiertos para ser resistentes a las salpicaduras de agua sin que ello suponga una pérdida del confort. Además, son resistentes a los rayos UV. Los núcleos de espuma, creados exclusivamente para DEDON, y el relleno de fibra sintética están cubiertos por una envoltura impermeable, transpirable y no tejida. Después de un aguacero, permita que sus cojines se sequen con el fin de protegerlos de las manchas de moho. Le recomendamos que guarde sus cojines durante el invierno o cuando no se usen durante largos períodos de tiempo, y usar las fundas para mantenerlos siempre óptimos. Antes de guardarlos, asegúrese de que están completamente secos. Nuestros materiales cumplen con los más altos estándares de calidad para uso al aire libre. Todos los tejidos son de secado rápido y fáciles de mantener.

DIEZ TIPOS DE TEJIDOS PARA COMBINAR

Cada uno de los diez tejidos que hay en este catálogo posee su propia estructura de tejido que lo diferencia y le confiere, por lo tanto, una apariencia y un tacto completamente únicos. Aunque cualquiera de los tejidos que se ofrecen sería un recubrimiento ideal tanto para cojines grandes como pequeños, la oportunidad sin precedentes de combinar múltiples tejidos es lo que confiere un gran atractivo a las colecciones de DEDON. Juegue con las texturas combinando la fresca veraniega de COOL con la robustez de GLAN que recuerda al tejido tweed. Cree sutiles matices trabajando con el mismo color en diferentes texturas. Disfrute de poder combinar y crear bajo cielo abierto de la misma manera que con los exquisitos tejidos de interior.

IT CUSCINI DA POTER LASCIARE ALL'ESTERNO

DEDON sfrutta alcune delle tecnologie più avanzate del mondo nel settore tessile per creare cuscini da poter lasciare all'esterno. Grazie a un rivestimento particolare, i nostri materiali acrilici sono resistenti agli spruzzi d'acqua, senza perdere la loro comodità. Sono anche resistenti ai raggi UV. Le anime in schiuma, create esclusivamente per DEDON e le imbottiture in fibra sintetica sono inserite in un involucro idrorepellente, traspirante, in tessuto non tessuto. Dopo la pioggia, far asciugare i cuscini in modo da prevenire la formazione di macchie di umidità. In inverno o in caso di lunghi periodi di inutilizzo, si consiglia di riporre i cuscini coprendoli con dei teli per mantenerli al meglio. Prima di riporli, assicurarsi che siano perfettamente asciutti. I nostri materiali rispondono ai più rigorosi standard di qualità per l'uso outdoor. Tutti i tessuti sono di rapida asciugatura e di facile manutenzione.

DIECI TIPI DIVERSI DI TESSUTI PER SBIZZARRIRISI

Tutti i dieci tipi di tessuti in questo catalogo presentano una speciale struttura di tessuto dal look distintivo. Ogni stoffa è perfetta per foderare piccoli o grandi cuscini, ma ciò che rende così speciale la collezione Dedon è la possibilità di creare infinite combinazioni. Giocate con i tessuti, combinando la freschezza estiva di COOL con la robustezza del tessuto GLAN, che ricorda le stoffe tweed. Create sottili contrasti di nuance, utilizzando diverse strutture di tessuto nella stessa tonalità di colore. La flessibilità e la creatività tipicamente associata ai più lussuosi ambienti interni può oggi arredare anche gli spazi a cielo aperto.

FR DES COUSSINS QUE VOUS POUVEZ LAISSER DEHORS

DEDON travaille avec les technologies textiles les plus avancées au monde pour concevoir des coussins que vous pouvez laisser dehors. Grâce à un revêtement spécifique, nos matériaux acryliques de haute qualité sont protégés contre les éclaboussures, sans que cela n'influe sur leur confort. En outre, ils sont résistants aux rayons UV. Le cœur en mousse, conçu spécialement pour DEDON, et le rembourrage en fibres synthétiques sont enveloppés dans un tissu non-tissé respirable et hydrofuge. Après une averse, faites sécher vos coussins, afin de prévenir l'apparition de moisissure. Nous vous recommandons de ranger vos coussins pendant l'hiver ou lorsqu'ils ne sont pas utilisés sur le long-terme et d'utiliser des housses pour conserver leur qualité. Avant de les ranger, assurez-vous qu'ils soient complètement secs. Nos matériaux sont un gage de qualité pour une utilisation extérieure. Tous les tissus sèchent rapidement et sont faciles d'entretien.

DIX TYPES DE TISSUS PERMETTENT DE VARIER LES PLAISIRS

Chacune des dix variantes de tissus présentées dans ce catalogue dispose de sa propre structure tissée incomparable. De fait, son style est unique et l'impression laissée par sa vue et son toucher est sans pareil. Si chacun de nos tissus est parfaitement approprié pour recouvrir les housses de nos coussins, qu'ils soient petits ou grands, ce sont surtout les possibilités de combinaison qui rendent l'assortiment de tissus DEDON si intéressant. Jouez avec les textures, en combinant la fraîcheur estivale du COOL et la robustesse du GLAN qui rappelle les tissus en tweed. Créez des nuances de couleurs subtiles en combinant différentes structures dans le même contexte chromatique. Réjouissez-vous de pouvoir laisser libre cours à votre créativité et à la diversité à l'extérieur comme vous y êtes habitué avec les tissus d'intérieur les plus nobles



DECO CUSHIONS

DECO CUSHIONS

Dekokissen
Cojines de decoración
Cuscini decorativo
Coussins déco

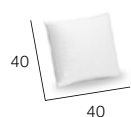

95050081

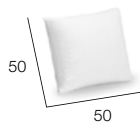

95050082

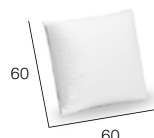

95050084



95050086



95050088

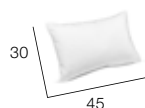

95050089

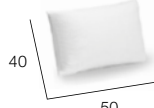

95050085



95050083

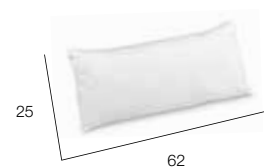

95050090

DEDON fabrics per meter

DEDON Stoffe Meterware
DEDON tela a metros
DEDON tessuti al metro
DEDON tissus au mètre

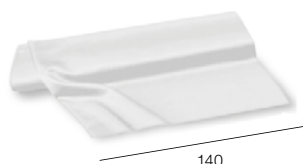

95060092

LA MALLE CUSHIONS TRUNK

Design by LORENZA BOZZOLI & THE KINGS

CUSHIONS TRUNK XL

Kissentruhe XL
Baúl para cojines XL
Baule per cuscini XL
Coffre à coussins XL
66,5 kg 1,58 m³

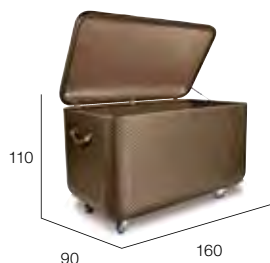

072010040

INTERIOR DIMENSIONS (W x H x D)
Abmessungen innen (B x H x T)
Dimensiones interiores (a x a x f)
Dimensioni interne (L x H x P)
Dimensions partie intérieure (L x H x P)
152 x 82 x 87 cm



072010

EN Opening and closing of the lid is assisted by pneumatic springs. All trunks are designed for short-term storage of DEDON cushions and pillows. Ensure the cushions are completely dry before storing them in the trunk. The trunk can be used in covered outdoor areas as well as indoors. Customized XL cushions trunk available in other DEDON weaves and colors, subject to surcharge.

DE Das Öffnen und Verschließen des Deckels wird durch Gasdruckfedern unterstützt. Alle Truhen dienen einem kurzzeitigen Verstauen der DEDON-Kissen und Polster. Stellen Sie sicher, dass die Kissen vollständig trocken sind, bevor Sie sie in die Truhe legen. Die Truhe ist im überdachten Außenbereich sowie im Innenbereich einsetzbar. Individuell angefertigte Kissentruhe XL in anderen DEDON-Flechtungen und Farben gegen Aufpreis möglich.

ES Unos muelles neumáticos facilitan la apertura y el cierre de la tapa. Todos los baúles sirven para almacenar cojines y acolchados durante un breve período de tiempo. Asegúrese de que los cojines estén completamente secos antes de depositarlos en el baúl. El baúl se puede utilizar en exteriores techados y en interiores. El baúl para cojines XL con acabado personalizado se puede adquirir en otras fibras DEDON y colores bajo recargo adicional.

IT L'apertura e la chiusura del coperchio sono facilitate da molle pneumatiche. Tutti i bauli sono progettati per riporre i cuscini DEDON per brevi periodi. Assicuratevi che i cuscini siano completamente asciutti prima di metterli nei bauli. I bauli sono utilizzabili sia in ambienti esterni che interni. Il baule per cuscini XL può essere realizzato in altre varianti di colore DEDON con un supplemento di prezzo.

FR L'ouverture et la fermeture du couvercle est assistée par des ressorts à gaz. Tous les coffres permettent de ranger les coussins et les matelas de DEDON pour une courte durée. Assurez-vous que les coussins sont entièrement secs, avant de les ranger dans le coffre. Le coffre peut être utilisé dans un espace extérieur protégé des intempéries ainsi qu'à l'intérieur. Coffre à coussins XL personnalisé, disponible sur demande dans d'autres fibres et coloris DEDON, moyennant un supplément.

FABRICS

CATEGORY A – For all collections

COOL Acrylic

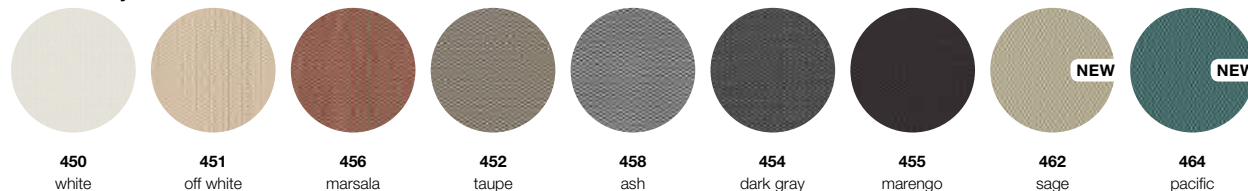

CATEGORY B – For all collections

LINEN Acrylic

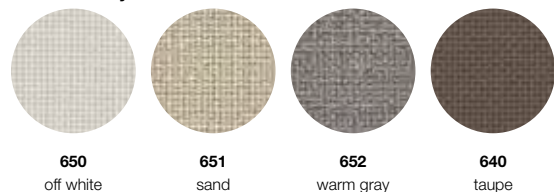

TWELLO Acrylic

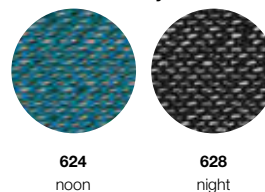

TWIST Polypropylene



MAR Polypropylene



PATIO by Kvadrat Trevira CS

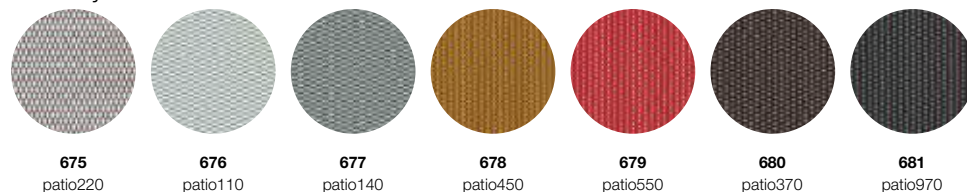

CATEGORY C – Fabrics are exclusive to specific collections

PUNO Acrylic

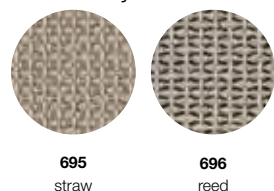

DUNE Acrylic



GLAN Polypropylene

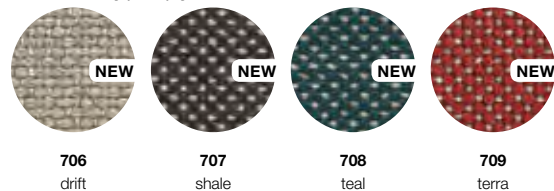

DOTS Polypropylene

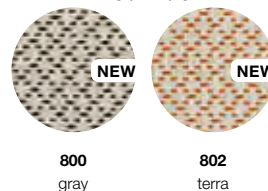

	SEALINE	BREA	BRIXX	DECO CUSHIONS
GLAN	✓	✓	-	✓
PUNO	✓	✓	✓	✓
DUNE	✓	✓	✓	✓
DOTS	-	-	-	✓

All fabrics are quick-drying, UV-resistant and easy to maintain.

1. GLAN A thick and hearty fabric, available in four colors, GLAN is distinguished by its inviting 3D woven structure.

2. LINEN is an exceptionally comfortable fabric with a natural look and feel and a contemporary color palette.

3. COOL A light, soft, summery fabric in a strié weave, COOL has a cotton-like touch and carries color beautifully.

4. MAR Made of a blend of colored yarns in a basket weave, MAR is available in four colors, each one rich and complex.

5. TWIST Woven from fine twisted yarn, TWIST is a fresh, cool fabric with depth, structure and a lively color effect.

6. TWELLO A heavy-weight and robust fabric, TWELLO is woven with twisted yarns for a crisp, fresh and inviting touch.

7. PATIO BY KVADRAT With its subtle woven structure, PATIO by Kvadrat stands out for its softness and exceptional color vibrancy.



QUALITY

EN BEST REASONS FOR CHOOSING DEDON

PRODUCED IN OUR OWN FACILITIES

The manufacturing of both DEDON Fiber in Germany and DEDON furniture in the Philippines take place in our own production facilities. This is unique in the outdoor furniture industry and ensures that fine craftsmanship is combined with innovative technology. DEDON's master weavers in the Philippines use ultra-strong fibers from our own DEDON production.

WORLD'S BEST FIBER

No matter if it's desert wind, salt water or frost, DEDON Fiber is tested against all weather conditions and for 10 years' UV resistance. Produced in Germany by our team of specialists, it is unrivaled for strength, color fastness and longevity. And because DEDON Fiber is developed entirely in-house, we are able to work with designers to create innovative solutions, including unique colors, textures and profiles.

THE RIGHT MATERIAL FOR EVERY SETTING

Specialists in outdoor living spaces of all kinds, DEDON selects the right material for every setting, from covered terraces to exposed poolside to sandy beaches to wild nature. That's why, in addition to the world's best fiber, we work with highest-quality teak, aluminum, woven textiles, ceramics and upholstery, all manufactured with passion for excellence.

SUSTAINABILITY

It is DEDON's corporate philosophy to create furniture and accessories of such high quality that they need never be thrown away. Produced in our environmentally-sound facilities in Northern Germany, DEDON fiber is 100% recyclable and free from pollutants and heavy metals. In addition DEDON incorporates recycled materials into our products whenever feasible.

DESIGN

DEDON collaborates with the world's top designers, from famous names to rising stars, on collections that consistently win the most prestigious design awards. Our in-house research and development department is able to work closely with each designer on solutions and innovations that make all the difference in terms of quality, function and style.

DE DIE BESTEN GRÜNDE FÜR DEDON

EIGENE PRODUKTION

Sowohl die Herstellung der DEDON-Faser in Deutschland, als auch die Möbelproduktion auf den Philippinen findet in eigenen Produktionsstätten statt – dies ist einzigartig in der Outdoor-Möbel-Branche. Handwerkskunst verbindet sich mit innovativer Technik – die DEDON-Meisterflechter auf den Philippinen verwenden hochbelastbare Fasern aus der eigenen DEDON-Produktion.

DIE WELTBESTE FASER

Egal ob Wüstenwind, Salzwasser oder Frost – die DEDON-Faser ist gegen alle Witterungen und auf 10 Jahre UV-Beständigkeit getestet. Die in Deutschland von unserem Spezialistenteam hergestellte Faser ist in Sachen Reißfestigkeit, Farbbeständigkeit und Langlebigkeit konkurrenzlos. Und weil wir bei DEDON unsere Fasern komplett im eigenen Hause entwickeln lassen, können wir in Zusammenarbeit mit unseren Designern innovative Lösungen entwickeln - einschließlich neuer Farben, Oberflächen und Faserprofile.

DIE RICHTIGEN MATERIALIEN FÜR JEDE UMGEBUNG

Als Spezialisten für alle Bereiche des Outdoor Living setzen wir bei DEDON auf die richtigen Materialien für jedes Umfeld, von der schattigen Terrasse bis zur prallen Sonne eines Poolbereichs, vom feinen Sandstrand bis zur wilden Naturlandschaft. Deshalb verwenden wir nicht nur die weltbeste Faser, sondern setzen auch ausschließlich Teakholz, Aluminium, Webtextilien, keramische Materialien und Polsterungen von höchster Qualität ein, die mit leidenschaftlichem Qualitätswillen gefertigt wurden.

NACHHALTIGKEIT

Es ist Teil der Unternehmensphilosophie von DEDON, dass wir Möbel und Accessoires von so hoher Qualität fertigen, dass sie ein Leben lang halten. Die DEDON-Faser, die in unserer umweltverträglich arbeitenden Produktionsstätte in Norddeutschland hergestellt wird, ist zu 100% recycelbar und frei von Schadstoffen und Schwermetallen. Darüber hinaus setzen wir bei der Herstellung unserer Produkte so oft wie möglich recycelte Materialien ein.

DESIGN

DEDON arbeitet mit Top-Designern aus aller Welt – vom Designer mit großem Namen bis zum aufstrebenden Jungdesigner – zusammen. So entstehen Kollektionen, die immer wieder die prestigeträchtigsten Designpreise gewinnen. Dabei arbeitet unsere hauseigene Entwicklungsabteilung eng mit den Designern zusammen, um so Lösungen und Innovationen zu schaffen, die sich in Qualität, Funktionalität und Stil entschieden absetzen.

ES LOS MEJORES MOTIVOS PARA ELEGIR DEDON

PRODUCCIÓN PROPIA

Tanto la fabricación de la fibra DEDON en Alemania como la producción de muebles en Filipinas se desarrollan en nuestros propios centros, una característica única dentro del sector del mobiliario de jardín. El trabajo artesanal se combina con la tecnología más innovadora: como resultado, los maestros tejedores de Filipinas emplean fibra de alta resistencia, fabricada por DEDON en régimen de producción propia.

LA MEJOR FIBRA DEL MUNDO

Da igual que sea viento del desierto, agua de mar o escarcha: la fibra DEDON ha demostrado que es capaz de resistir todas estas agresiones y soportar sin alteraciones la acción de los rayos ultravioleta hasta 10 años. Fabricada en Alemania por nuestro equipo de especialistas, no tiene rival en lo que se refiere a fortaleza, solidez del color y durabilidad. Y dado que la fibra DEDON es desarrollada completamente en casa, podemos trabajar conjuntamente con nuestros diseñadores para crear soluciones innovadoras, incluyendo colores, superficies y formas nuevas.

MATERIALES CORRECTOS PARA TODOS LOS AMBIENTES

Siendo especialista en todo tipo de espacios al aire libre, DEDON selecciona el material correcto para cada ambiente: desde terrazas cubiertas a piscinas con sol abrasador directo, desde playas arenosas hasta naturaleza salvaje. Por eso, además de la mejor fibra del mundo, trabajamos también con madera teca, aluminio, tejidos textiles, cerámicas y tapizados de la más alta calidad, todos fabricados con la mejor calidad.

SOSTENIBILIDAD

La filosofía corporativa de DEDON es fabricar muebles y accesorios de tan alta calidad que duren toda la vida. La fibra DEDON se fabrica en nuestras instalaciones seguras y respetuosas con el medio ambiente del norte de Alemania. Es 100% reciclable y no contiene ningún tipo de sustancias tóxicas ni metales pesados. Además, siempre que sea factible, incorporamos materiales reciclados en nuestros productos.

DISEÑO

DEDON colabora con los mejores diseñadores del mundo, desde reputados diseñadores, hasta diseñadores emergentes, para crear colecciones que siempre ganan los premios de diseño más prestigiosos. Nuestro departamento de investigación y desarrollo trabaja estrechamente con los diseñadores para crear soluciones e innovaciones que marquen la diferencia en términos de calidad, funcionalidad y estilo.

IT I MIGLIORI MOTIVI PER SCEGLIERE DEDON

PRODUZIONE PROPRIA

Sia la fibra DEDON prodotta in Germania che i mobili realizzati nelle Filippine sono fabbricati in stabilimenti produttivi di proprietà dell'azienda – si tratta di una caratteristica unica nel settore degli arredi outdoor. L'arte artigiana si combina alla tecnologia più innovativa: i maestri tessitori nelle Filippine utilizzano fibre di elevatissima resistenza prodotte da DEDON.

LA MIGLIORE FIBRA DEL MONDO

Sia che si tratti del vento del deserto, dell'acqua salina o del gelo, la fibra DEDON è stata sottoposta a test di resistenza ai raggi UV per 10 anni. Prodotta in Germania dal nostro team di specialisti, essa non teme confronti in quanto a resistenza, tenuta dei colori durante il lavaggio e durata. E poiché la fibra DEDON viene prodotta completamente in-house, siamo in grado di lavorare direttamente con i nostri designer per creare soluzioni innovative, che si traducono in colori, tessuti e profili straordinari e unici.

I MATERIALI GIUSTI PER QUALSIASI AMBIENTAZIONE OUTDOOR

Da esperti specialisti in spazi living outdoor, DEDON seleziona sempre i materiali giusti per ogni ambientazione, dalle terrazze coperte ai bordi delle piscine, dalle spiagge agli ambienti naturali selvaggi. Questo è il motivo per cui, oltre ad offrire la fibra migliore del mondo, impieghiamo legno teak della qualità più pregiata, alluminio, tessuti, ceramiche e tappezzerie, tutto creato e realizzato con l'idea di raggiungere l'eccellenza.

SOSTENIBILITÀ

Fa parte della filosofia aziendale la missione che DEDON si è prefissata: produrre elementi d'arredo ed accessori di qualità talmente elevata da non dover mai essere gettati. Prodotta nei nostri stabilimenti a basso impatto ambientale nella Germania del nord, la fibra DEDON è riciclabile al 100% e priva di sostanze tossiche e di metalli pesanti. Inoltre, DEDON cerca di utilizzare materiale riciclato quando è possibile.

DESIGN

DEDON collabora con i più importanti designer del mondo, sia già affermati che emergenti, su collezioni che vengono spesso premiate con i più prestigiosi riconoscimenti internazionali nel campo del design. Il nostro centro studi e ricerca lavora costantemente a stretto contatto con i designer per definire le soluzioni e le innovazioni che contribuiscono a rendere i prodotti eccellenti in termini di qualità, funzionalità e stile.

FR LES MEILLEURES RAISONS DE CHOISIR DEDON

UNE PRODUCTION MAISON

La fabrication de la fibre DEDON en Allemagne, tout comme la production de meubles aux Philippines, se font dans nos propres sites de production – ce qui est unique dans le monde du mobilier d'extérieur. Quant l'artisanat se combine avec une technique innovante – les maîtres-tisserands de DEDON aux Philippines utilisent des fibres très résistantes, toutes issues de la production interne de DEDON.

LA MEILLEURE FIBRE AU MONDE

Que ce soit le vent du désert, l'eau salée ou le gel, la fibre DEDON est testée sous toutes les conditions climatiques et pour 10 ans de résistance aux UV. Produite en Allemagne par notre équipe de spécialistes, cette fibre a une solidité, une stabilité des couleurs et une longévité sans égal. Grâce à notre production exclusivement interne de la fibre DEDON, nous sommes en mesure de travailler avec des designers pour concevoir des solutions innovantes, des couleurs, des textures et des profils uniques.

LES MEILLEURS MATÉRIAUX POUR CHAQUE ENVIRONNEMENT

En tant que spécialiste des espaces de vie extérieure de tout type, DEDON sélectionne les matériaux appropriés à chaque environnement, que ce soit des terrasses ombragées aux piscines exposées en plein soleil, en passant par les plages de sable fin et la nature sauvage. C'est pourquoi nous combinons la meilleure fibre au monde avec du teck, de l'aluminium, des textiles tissés, de la céramique et du tissu d'ameublement de la plus haute qualité et produits avec la passion de l'excellence.

DURABILITÉ

La philosophie d'entreprise de DEDON consiste à produire des meubles et des accessoires d'une qualité telle qu'ils durent toute la vie. Élaborée dans nos sites de production respectueux de l'environnement dans le nord de l'Allemagne, la fibre DEDON est recyclable à 100% et sans polluants ni métaux lourds. De plus, DEDON intègre à ses produits des matériaux recyclés à chaque fois que cela est possible.

DESIGN

DEDON travaille avec les meilleurs designers au monde, aussi bien avec des grands noms qu'avec des étoiles montantes. Les collections qui en résultent remportent toujours les récompenses les plus prestigieuses en matière de design. Notre département interne de Recherche et Développement collabore étroitement avec chaque designer à l'élaboration de solutions et d'innovations qui font toute la différence en termes de qualité, de fonction et de style.





DEDON GmbH

Zeppelinstrasse 22
21337 Lüneburg / Germany
Tel. +49 41 31 / 22 44 70
Fax +49 41 31 / 22 44 7 630
info@dedon.de

DEDON Asia Pacific Limited

Hong Kong
Tel. +852 / 3952 8787
Fax +852 / 3952 8700
office@dedon.hk

DEDON Inc.

657-C Brigham Road
Greensboro, NC 27409
877-693-3366
office@dedon.us